

New Products

ISO6789-2017 Models: DB, CDB-S, T-S

New ISO standard compatible models released

PTA-G-BT: Battery type Torque Screwdriver

Torque & angle monitoring, data transfer function

MPCL: Spanner type Marking Torque Wrench

Pre-lock type is newly added to Marking Spanner series

DECA2: 10:1 Ratio Torque Multiplier

Shorter and lighter weight, added ratcheting function

Scan QR Code for latest online information
<http://www.global-tohnichi.com>



Your Torque Partner

Through advances in torque technology, Tohnichi contributes to the creation of a safer world by helping to obtain the highest level of product safety in transportation, information technology, and many other fields that affect our daily lives.

TORQUE CENTER

A wide variety of services available including: theoretical information, application assistance, training seminars, and testing facilities.



Tohnichi Torque Center in Tokyo

Laboratory

Visitors can use this space. Actual work piece is carried in and proper tightening torque can be measured.



Showroom

Tohnichi torque products are set-up and displayed so that visitor can have a clear look on what is available on the torque market and what will be coming up soon.



Lecture room

Various courses of torque engineering seminars are available.



Training room

Our customers can attend workshops, covering a global training, general repair and adjustment on torque products.



The above facilities and services are available at Tokyo, Osaka, Nagoya in Japan, Tohnichi Shanghai in China, Tohnichi Europe in Belgium, and Tohnichi America in Chicago.

Contents

How to Select Torque Products	1
From Torque Control to Tightening Assurance System	3

Torque Screwdriver

RTD	Rotary Slip Adjustable Torque Screwdriver	5
LTD	Adjustable Torque Screwdriver	5
Torque Screwdriver Optional Accessories		
RNTD	Rotary Slip Preset Torque Screwdriver	6
NTD	Preset Torque Screwdriver	6
RTDZ	Insulated Rotary Slip Adjustable Torque Screwdriver	6
RNTDZ	Insulated Rotary Slip Preset Torque Screwdriver	6
AMRD/BMRD	Rotary Slip Adjustable Torque Screwdriver for Small Screws ..	7
AMLD/BMLD	Adjustable Torque Screwdriver for Small Screws	7
MNTD	Marking Torque Screwdriver	8
RTDLS/RNTDLS	Rotary Slip Type Torque Screwdriver with Limit Switch	8
RTDFH/RNTDFH	Rotary Slip Type Pokayoke Torque Screwdriver	8
FTD	Dial Indicating Torque Screwdriver with Memory Pointer	9
MTD	Micro Dial Indicating Torque Screwdriver	9
STC2-G/BT	Digital Torque Screwdriver	9
Interchangeable Bit		10

Torque Wrench for Assembly

QL/QLE2	Ratchet Head Type Adjustable Torque Wrench	11
QL-MH	QL with Metal Handle	11
CL/CLE2	Interchangeable Head Type Adjustable Torque Wrench	12
CL-MH	CL with Metal Handle	12
DQL/DQLE2	Dual Square Drives Type Adjustable Torque Wrench ..	13
TW2	Adjustable Torque Wrench with Multiplier	13
MTQL	Torque Wrench for Motorsports	13
TIQL/TIQLE	Titanium Adjustable Torque Wrench	14
PHL/PHLE2	Pipe-Wrench Head Type Adjustable Torque Wrench ..	14
QRSP	Open Ring Head Type Preset Torque Wrench	14
PQL	Ratchet Head Type Pre-Lock Torque Wrench	15
PQLZ	Pre-Lock Adjustable Insulated Torque Wrench	15
QSPZ	Preset Insulated Torque Wrench	15
CLWP	Water Proof and Dust Free Torque Wrench	15
PCL	Interchangeable Head Type Pre-Lock Torque Wrench	16
MT70N	Moto Torq/Pre-Lock Specialty Torque Wrench	16
SCL	European Style Interchangeable Head Type Adjustable Torque Wrench	16
SCSP	European Style Interchangeable Head Type Preset Torque Wrench	16
QSP	Ratchet Head Type Preset Torque Wrench	17
QSP-MH	QSP with Metal Handle	17
BQSP	Bi-Directional Type Preset Torque Wrench	17
CSP	Interchangeable Head Type Preset Torque Wrench ..	18
CSP-MH	CSP with Metal Handle	18
BCSP	Bi-Directional Interchangeable Head Type Preset Torque Wrench	18
SP2/-MH	Open End Head Type Preset Torque Wrench	19
RSP2/-MH	Ring Head Type Preset Torque Wrench	19
SP2-H	Torque Wrench for Piping Work	20
SP2-N/-MH	Notched Head Type Preset Torque Wrench	20
NSP100CNx8	Break-Over Torque Wrench	20
QSPCA	Slip Type Torque Wrench	21
YCL2	Two Step Motion Torque Wrench	21
CPT-G	PRO TORQ/Digital Torque Wrench for Tightening	22
CTA2-G	Digital Torque and Angle Wrench	23
DWQL	Analog Torque Wrench with Digital Angle Module	24
WQL	Analog Torque and Angle Wrench	24
MPQL/MQL	Marking Preset Torque Wrench	25
MQSP	Marking Torque Wrench	25
MCSP/MPCL	Marking Torque Wrench for Bolt, Nut Tightening	26
CMQSP	Marking Torque Wrench for Hex Screws	26
CNA-4mk3	POKA Patrol/Count Checker	27
Torque Wrench with Limit Switch		
R-CM	Modular Conversion Receiver	29
FH Series	Radio Frequency Torque Wrench System	30
FHW	Radio Frequency Torque Wrench with Double Tightening Detection	31
BL	Battery Less Wireless Torque Wrench	32
FMA	Radio Frequency Torque Wrench System	32
Tightening Data Management System		
FD/FDD	Click type Torque Wrench with Wireless Data Transfer ..	33
FDD-AD	Click type Torque Wrench with Torque and Angle Data Transfer	34
CSPLD/CSPLDC	Click type Torque Wrench with Wired Data Transfer function	35
TDMS	Tightening Data Management Software	36
CEM3-G-BTS/-BTD	Wireless Data Transfer Digital Torque Wrench	37
CEM3-G-WF	Wireless LAN communication Digital Torque Wrench ..	37
CEM3-G-BTA	Wireless Torque and Angle Digital Torque Wrench	38

Torque Wrench for Quality Inspection

CEM3-G	DATA TORQ/Digital Torque Wrench	39
CEM3-P	DATA TORQ/Programmable Digital Torque Wrench	39
CTB2-G	Digital Retightening Torque Wrench	40
DB/DBE/DBR	Dial Indicating Torque Wrench	41
CDB-S	Interchangeable Head Type Dial Indicating Torque Wrench	42
SCDB-S	European Style Interchangeable Head Type Dial Indicating Torque Wrench	42
T-S	T-Handle Dial Indicating Torque Wrench	42
SF/FFR	Beam Type Torque Wrench	43
CSF/CF	Interchangeable Head Type Beam Type Torque Wrench	43
QF/QFR	Ratchet Head Beam Type Torque Wrench	43
Interchangeable Socket		44

Accessories

Interchangeable Head	45
Auxiliary Equipment	49
Connecting Cable	50
Quick Charger, Battery Pack, AC Adapter	50

Power Torque Tool

A3/AC3	Semi-Automatic Airtork	51
AUR	UNITORK/Pistol Type Pneumatic Torque Screwdriver	51
HAC	Battery Operated Semi-Automatic Torque Wrench	52
HAT/HATFH	HANDYTORK/Battery Operated Torque Screwdriver	52
PTA-G-BT	Fully-Automatic Electric Torque Screwdriver	53
U/UR	UNITORK/Straight & Pistol Pneumatic Torque Screwdriver	53
MG/MF	Multiple Unit/Pneumatic Straight Style	53
AP2	Fully-Automatic Airtork	54
ME/MC2	Multiple Unit/Pneumatic Straight Style	54
Optional Accessories for Multiple Unit		54

Torque Tester/Checker

DOE4-G	Digital Torque Wrench Tester	55
DOT	Analog Torque Wrench Tester	55
DOE4-G-MD2	Digital Torque Wrench Tester with Motor Driver Loader	56
TCC2-G	Digital Torque Wrench Tester	56
TF	Fully Automatic Digital Torque Wrench Tester	57
TDT3-G	Digital Torque Screwdriver Tester	57
LC3-G	Torque Wrench Line Checker	58
ST3-G/ST3-G-BT	SPINTORK/Rotary Peak Torque Meter	58
ATG/BTG	Analog Torque Gauge	59
ATGE-G	Digital Torque Gauge	59
ExRcv Software		59
BTGE-G	Digital Torque Gauge	60
TME2	Digital Torque Meter	61
TM	Analog Torque Meter	61
TCF	Fixed Type Torque Sensor	62
TCF Optinal Accessories		62
TCR	Rotary Type Torque Sensor	62
Calibration Kit		63

Force Measurement Instrument

TT3000	Ultrasonic Tension Meter	65
TT2000/TT2000C	Ultrasonic Tension Meter	66
AFC-20G2	Axial Tension Calibrator	66
BTM/B-BTM	Bolt Tension Meter	67
Fcon	Bolt Tension Stabilization	67

Optional Equipment

TPC/TPC2	Protocol Converter	68
CD5	Compact Display	69
EPP16M3	Printer	69
R-DT999	Data Tank	69
DFS	Data Filing System/CD-ROM	69
DECA/DECA2	10:1 Ratio Torque Multiplier	70
EVERTORQUE	Lubricant for repair	70

Technical Data

Tohnichi ISO6789:2017 Compliance Status	71
Torque Settings for Torque Screwdrivers	73
Torque Settings for Torque Wrenches	74
Torque Conversion List	75
Standard Tightening Torque	76

How to Select Torque Products

Select the correct Tohnichi product for an application.

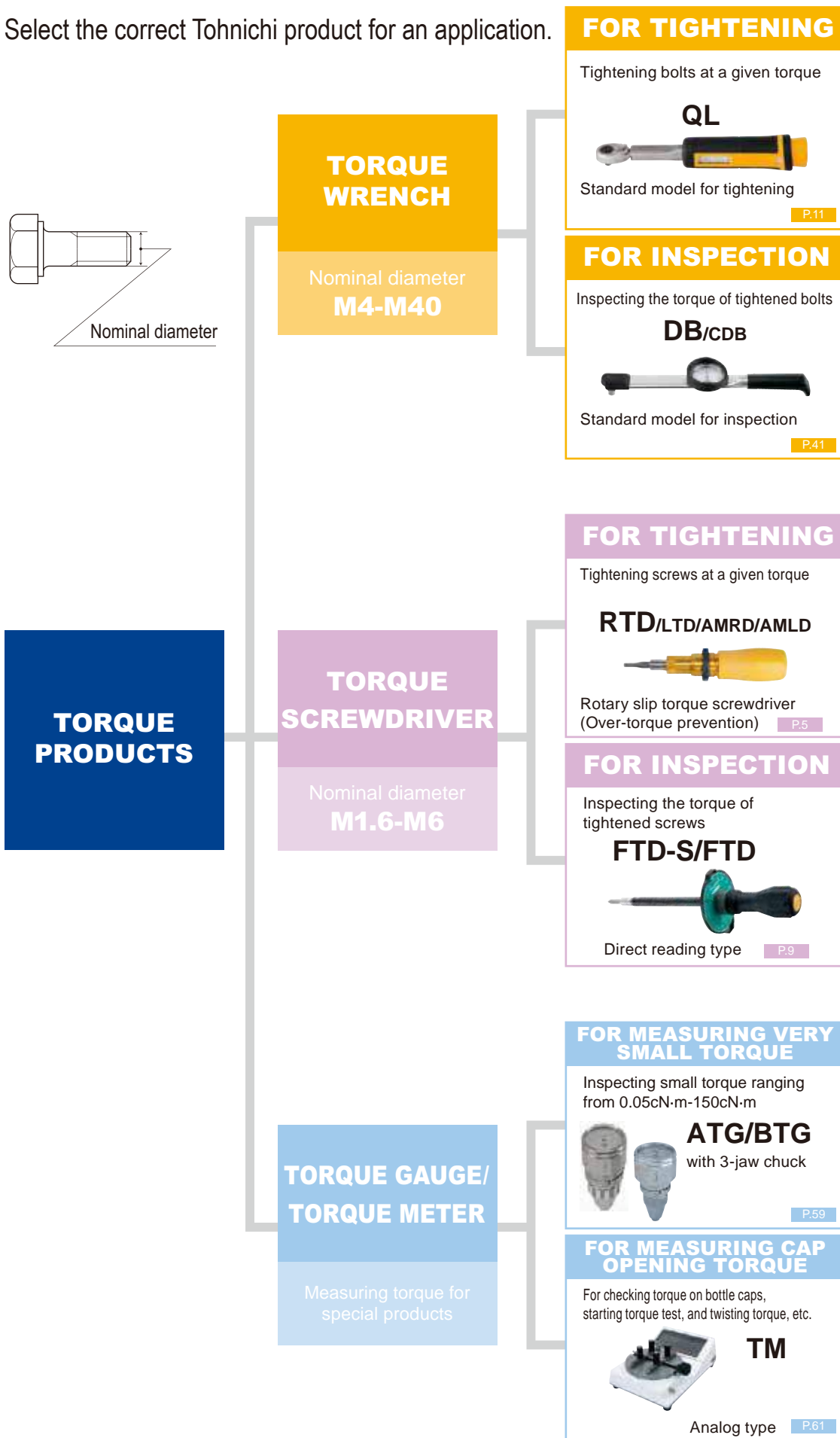

If other types of head is requested

CL



Interchangeable head version of QL P.12

In such working condition where resin handles are not suitable

QL-MH



Metal handle version of QL P.11

CL-MH



Metal handle version of CL P.12

If tightening at one particular torque only

QSP



Preset version of QL P.17

CSP



Interchangeable head version of QSP P.18

If tightening the same bolts at particular torque only

SP2



Preset type open end head P.19

SP2-MH



RSP2



Preset type ring head P.19

RSP2-MH



SF/F/QF/CF



Beam type P.43

CEM3-G/CTB2-G



Digital type P.39

For calibrating torque wrenches



TCC2-G

P.56



DOT E4-G

P.55

Tightening at one particular torque only

RNTD/NTD



Preset version of RTD P.6

For daily inspection of torque wrenches



LC3-G Line Checker P.54

STC2-G



Digital type P.9

Other Torque Wrench Testers:
DOT and TF models are also available.

Other Torque Measurement

ST3-G/TCF/TCR

P.58

P.62

ATGE-G



Digital type P.59

BTGE-G



Digital type P.60

Example

CL 100 N × 15D

Size of interchangeable head
* Interchangeable head type only

Unit (N = N·m, CN = cN·m, MN = mN·m)

Torque range (Maximum torque in S.I. unit)

Model

TME2



Digital type P.61

Please refer to the "Torque Handbook vol. 9" for further technical information.



From Torque Control to Tightening Assurance System

Tohnichi's Torque Assurance System advises the users how to tighten bolts properly and how to eliminate various mistakes which occur during bolt tightening operations.

Total Tightening Management System, which completes tightening assurance, will be created through cooperation of your staffs. Each component and product which consists of the system can be sold separately. The components and products are described in the catalog.

TOHNICHI TIGHTENING ASSURANCE SYSTEM

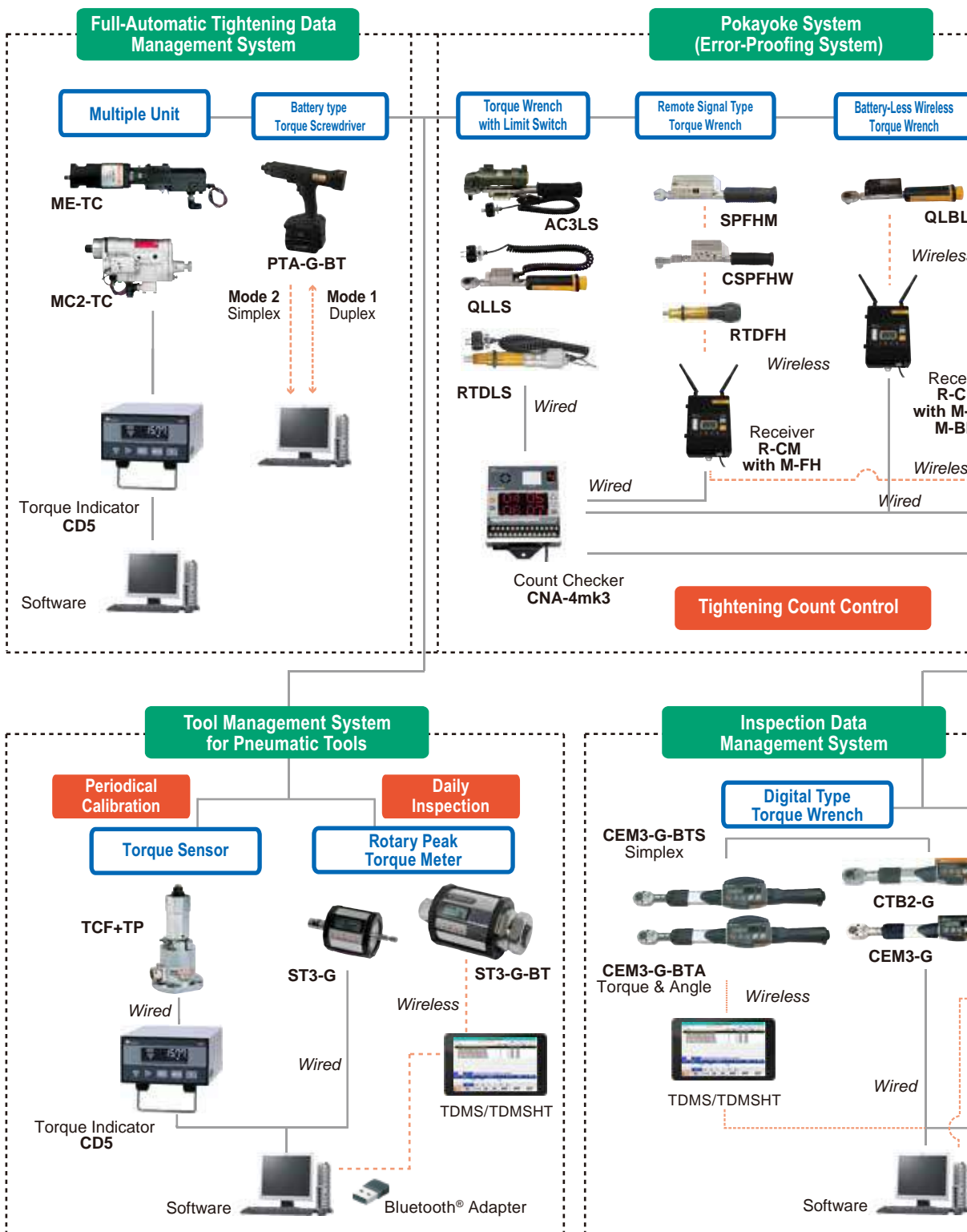

Characteristic factors (4M's) of defects in bolt tightening

- | | |
|--|---|
| <p>1. MAN (Tightening operator human error)</p> <ul style="list-style-type: none"> · Missed tightening · Improper tightening tool usage <p>2. METHOD (Improper tightening specification)</p> <ul style="list-style-type: none"> · Wrong tightening value specification · Wrong tightening procedure · Wrong tightening tool selection | <p>3. MACHINE (Improper tightening equipment)</p> <ul style="list-style-type: none"> · Inaccuracy · Mechanical failure <p>4. MATERIAL (Improper screw joint material)</p> <ul style="list-style-type: none"> · Part out of tolerance · Defective part material · Insufficient screw part lubricant |
|--|---|

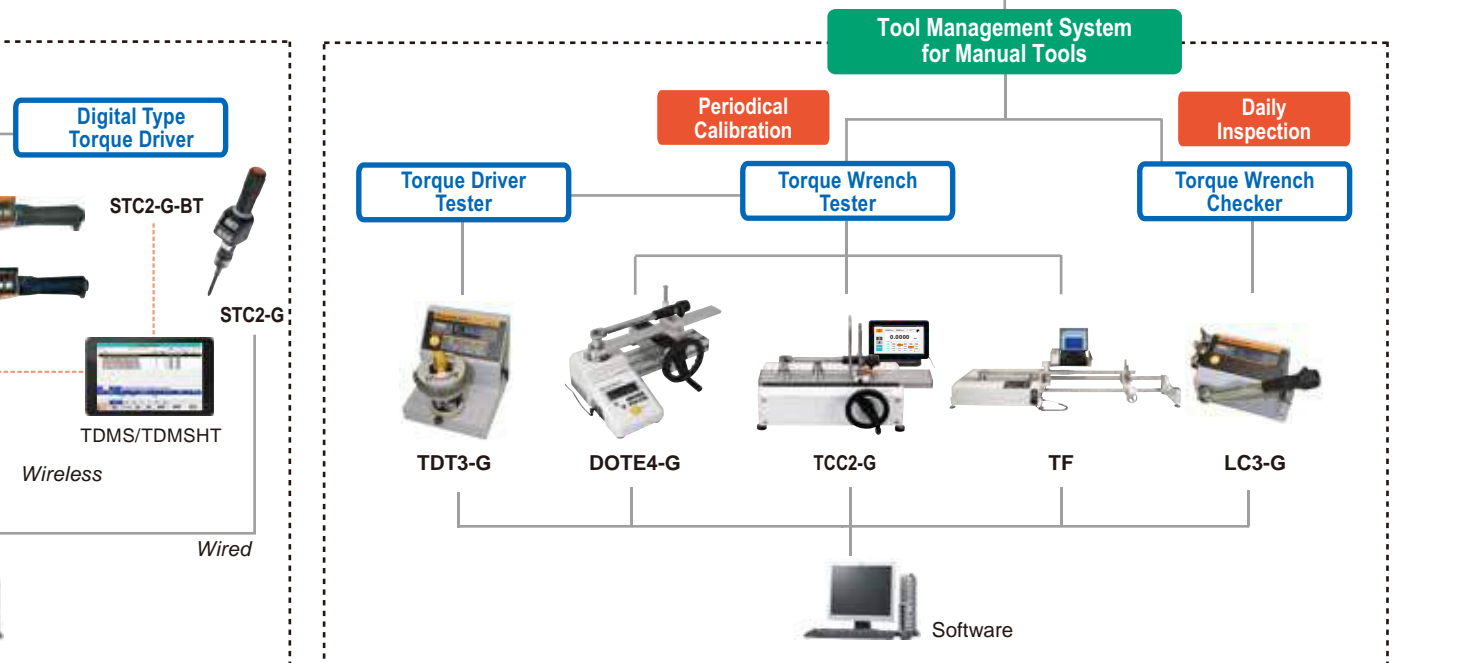
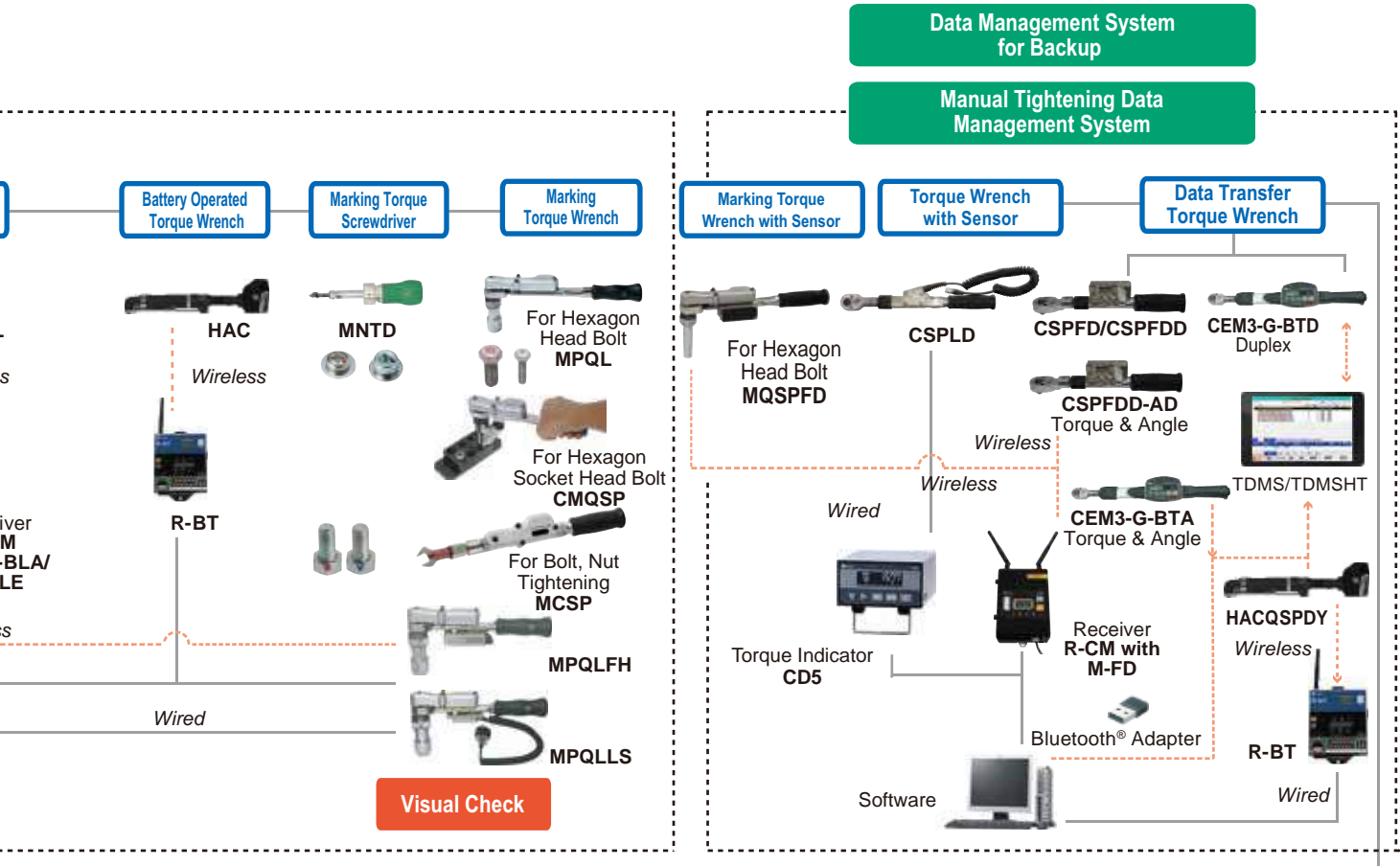

RTD

Rotary Slip Adjustable Torque Screwdriver

Direction

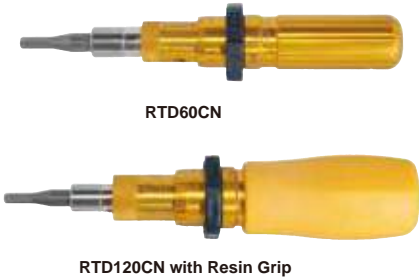

Assembly Adjustable Rotary Slip Graduation ISO6789:2003

- Ratcheting mechanism prevents over torque.
- Torque easily set with external scale

Accuracy ±3%

S.I. Model	Torque Range [cN·m]		Metric Model	Torque Range [kgf·cm]		American Model	Torque Range [ozf-in/lbf-in]		Overall Length [mm]	Weight [g]
	Min.-Max.	Grad.		Min.-Max.	Grad.		Min.-Max.	Grad.		
-	-	-	-	-	-	RTD20Z	6-20	0.2	100	50
-	-	-	-	-	-	RTD40Z	15-40	0.5	110	80
-	-	-	-	-	-	RTD80Z	20-80	1	130	160
-	-	-	-	-	-	RTD150Z	30-150	2	130	160
RTD15CN	2-15	0.1	1.5RTD	0.2-1.5	0.01	RTD1.3I	0.2-1.3	0.01	100	50
RTD30CN	4-30	0.2	3RTD	0.4-3	0.02	RTD2.6I	0.4-2.6	0.02	110	80
RTD60CN	10-60	0.5	6RTD	1-6	0.05	RTD5I	1-5	0.05	110	80
RTD120CN	20-120	1	12RTD	2-12	0.1	RTD10I	2-10	0.1	130	160
RTD260CN	60-260	2	26RTD	6-26	0.2	RTD22I	6-22	0.2	150	270
RTD500CN	100-500	5	50RTD	10-50	0.5	RTD40I	10-40	0.5	155	320

Note 1. Auxiliary tightening tool for RTD500CN is sold separately.
2. Bits are sold separately. Refer to page 10.

Standard Accessories 1. Hook spanner for RTD260CN and RTD500CN
2. Resin grip for RTD120CN and RTD260CN

LTD

Adjustable Torque Screwdriver

Direction



Assembly Adjustable Graduation ISO6789:2003

- Clicks at set torque value
- Torque easily set with external scale

Accuracy ±3%

S.I. Model	Torque Range [cN·m]		Metric Model	Torque Range [kgf·cm]		American Model	Torque Range [ozf-in/lbf-in]		Overall Length [mm]	Weight [g]
	Min.-Max.	Grad.		Min.-Max.	Grad.		Min.-Max.	Grad.		
-	-	-	-	-	-	LTD20Z	6-20	0.2	100	50
-	-	-	-	-	-	LTD40Z	15-40	0.5	110	80
-	-	-	-	-	-	LTD80Z	20-80	1	130	160
-	-	-	-	-	-	LTD150Z	30-150	2	130	160
LTD15CN	2-15	0.1	1.5LTD	0.2-1.5	0.01	LTD1.3I	0.2-1.3	0.01	100	50
LTD30CN	4-30	0.2	3LTD	0.4-3	0.02	LTD2.6I	0.4-2.6	0.02	110	80
LTD60CN	10-60	0.5	6LTD	1-6	0.05	LTD5I	1-5	0.05	110	80
LTD120CN	20-120	1	12LTD	2-12	0.1	LTD10I	2-10	0.1	130	160
LTD260CN	60-260	2	26LTD	6-26	0.2	LTD22I	6-22	0.2	150	270
LTD500CN	100-500	5	50LTD	10-50	0.5	LTD40I	10-40	0.5	155	320
LTD1000CN	200-1000	5	100LTD	20-100	0.5	LTD90I	20-90	0.5	185	580
LTD2000CN2	400-2000	5	LTD200M2	40-200	0.5	LTD180I2	40-180	0.5	255	1150

Note 1. Auxiliary tightening tool for LTD500CN and LTD1000CN is available, sold separately.
2. Bits are sold separately. Refer to page 10.
3. LTD2000CN2 and the equivalent metric and American models has an 9.53mm square drive head.

Standard Accessories 1. Hook spanner for LTD260CN-LTD2000CN2
2. LTD2000CN2 comes with an auxiliary tightening tool.
3. Resin grip for LTD120CN and LTD260CN

Torque Screwdriver Optional Accessories

RESIN GRIP for 120CN, 260CN

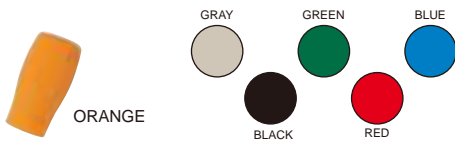

For 120CN

Part #	Color	Applicable Model
850	Orange	RTD120CN LTD120CN RNTD120CN NTD120CN
851	Gray	
852	Black	
853	Green	
854	Red	
855	Blue	

For 260CN

Part #	Color	Applicable Model
856	Orange	RTD260CN
857	Gray	LTD260CN
858	Black	RNTD260CN NTD260CN
859	Green	
860	Red	
861	Blue	

Resin Grip Dimensions

	120CN		260CN	
	RTD LTD	RNTD NTD	RTD LTD	RNTD NTD
Hexagon width across flats Maximum value [mm]	33		41	
Hexagon width across corner Maximum value [mm]	35		44	
Length [mm]	67		81	68
Overall Length with torque screwdriver [mm]	130	110	150	110

ADJUSTING TOOL for RTD/LTD

- Used for zero adjustment



Part #	Applicable Model
51	LTD/RTD15CN, 30CN
46	LTD/RTD60CN
1046	LTD/RTD120CN
47	LTD/RTD260CN
48	LTD/RTD500CN
49	LTD/RTD1000CN
1050	LTD2000CN2

AUXILIARY TIGHTENING TOOL for RTD/LTD/RNTD/NTD

- Make easier for large torque tightening



Part #	Applicable Model
31	LTD/RTD/NTD/RNTD500CN
32	LTD/NTD1000CN, RTDFH/RNTDFH500CN
40	LTD2000CN2
1031	RTDLS500CN RNTDSL500CN

HOOK SPANNER for RTD/LTD/MNTD

- Torque setting for middle and large size torque screwdriver



Part #	Applicable Model
52	LTD/RTD260CN, MNTD120CN
53	LTD/RTD500CN, MNTD260CN
54	LTD1000CN, MNTD500CN
55	LTD2000CN2

TORQUE ADJUSTING BAR for RNTD/NTD/RNTDZ

- Used for torque setting of preset torque screwdriver



Part #	Applicable Model
42	NTD/RNTD15CN-120CN
43	NTD/RNTD260CN, RNTDZ260CN
44	NTD/RNTD500CN-1000CN, RNTDZ500CN

RNTD Rotary Slip Preset Torque Screwdriver

Direction



RNTD120CN with Resin Grip

Assembly Preset Rotary Slip ISO6789:2003

- Preset version of RTD
- No external scale, torque set by a torque driver tester

Accuracy ±3%

Model	Torque Range			Overall Length [mm]	Weight [g]
	[cN·m]	[kgf·cm]	[lbf·in]		
	Min.-Max.	Min.-Max.	Min.-Max.		
RNTD15CN	5-15	0.5-1.5	0.5-1.3	95	71
RNTD30CN	10-30	1-3	0.9-2.5		
RNTD60CN	20-60	2-6	2-5		
RNTD120CN	40-120	4-12	4-10	110	110
RNTD260CN	100-260	10-26	9-23		180
RNTD500CN	200-500	20-50	20-40	120	270

Note

1. A torque driver tester is necessary for torque setting. Specify required set torque when you order. Ex. RNTD120CN x 100cN·m
2. Torque adjusting bar is sold separately. Refer to page 49.
3. Bits are sold separately. Refer to page 10.

Standard Accessories

1. Resin grip for RNTD120CN and RNTD260CN
2. Auxiliary tightening bar for RNTD500CN

NTD Preset Torque Screwdriver

Direction



NTD120CN with Resin Grip

Assembly Preset ISO6789:2003

- Preset version of LTD
- No external scale, torque set by a torque driver tester

Accuracy ±3%

Model	Torque Range			Overall Length [mm]	Weight [g]
	[cN·m]	[kgf·cm]	[lbf·in]		
	Min.-Max.	Min.-Max.	Min.-Max.		
NTD15CN	5-15	0.5-1.5	0.5-1.3	95	70
NTD30CN	10-30	1-3	1-2.5		
NTD60CN	20-60	2-6	2-5		
NTD120CN	40-120	4-12	4-10	110	110
NTD260CN	100-260	10-26	10-22		180
NTD500CN	200-500	20-50	20-40	120	270
NTD1000CN	400-1000	40-100	40-88	155	550

Note

1. A torque driver tester is necessary for torque setting. Specify required set torque when you order. Ex. NTD120CN x 100cN·m
2. Torque adjusting bar is sold separately.

Standard Accessories

1. Resin grip for NTD120CN and NTD260CN
2. Auxiliary tightening bar for NTD500CN and NTD1000CN

RTDZ Insulated Rotary Slip Adjustable Torque Screwdriver

Direction



RTDZ260CN

Assembly Adjustable Rotary Slip Resin Body Insulated ISO6789:2003

- Insulated design suited for use in electric shock hazard conditions
- Ideal for electric car assembly, connection of battery terminal wiring work etc

Accuracy ±3%

S.I. Model	Torque Range [cN·m]		Metric Model	Torque Range [kgf·cm]		Torque Range [lbf·in]		Overall Length [mm]	Weight [g]
	Min.-Max.	Grad.		Min.-Max.	Grad.	Min.-Max.	Grad.		
RTDZ260CN	60-260	2	26RTDZ	6-26	0.2	-	-	150	220
RTDZ500CN	100-500	5	50RTDZ	10-50	0.5	-	-	183	380

Note

1. Torque adjusting bar is sold separately.
2. Bits are sold separately. Refer to page 10.
3. Bits are not insulation coating.

RNTDZ Insulated Rotary Slip Preset Torque Screwdriver

Direction



RNTDZ500CN

Assembly Preset Rotary Slip Resin Body Insulated ISO6789:2003

- Insulated design suited for use in electric shock hazard conditions
- Ideal for electric car assembly, connection of battery terminal wiring work etc

Accuracy ±3%

S.I. Model	Torque Range [cN·m]		Metric Model	Torque Range [kgf·cm]		Torque Range [lbf·in]		Overall Length [mm]	Weight [g]
	Min.-Max.	Grad.		Min.-Max.	Grad.	Min.-Max.	Grad.		
RNTDZ260CN	100-260	-	-	10-26	-	10-22	-	123	240
RNTDZ500CN	200-500	-	-	20-50	-	20-40	-	138	340

Note

1. A torque driver tester is necessary for torque setting. Specify required torque when you order. Ex. RNTDZ260CN x 200cN·m
2. Torque adjusting bar is sold separately.
3. Bits are sold separately. Refer to page 10.
4. Bits are not insulation coating.

Torque Screwdriver



AMRD/BMRD

Direction Rotary Slip Adjustable Torque Screwdriver for Small Screws



AMRD4CN



BMRD30CN2

Assembly Adjustable Rotary Slip Graduation ISO6789:2003

- Low torque version of RTD
- AMRD includes Tohnichi original bits.

Accuracy ±3%

S.I. Model	Torque Range [cN-m]		Metric Model	Torque Range [gf-cm/kgf-cm]		American Model	Torque Range [ozf-in/lbf-in]		Overall Length [mm]	Weight [g]	Standard Accessory Bit	
	Min.-Max.	Grad.		Min.-Max.	Grad.		Min.-Max.	Grad.			⊕	⊖ Thickness x Width
AMRD	cN-m	cN-m		gf-cm	gf-cm		ozf-in	ozf-in				
AMRD1CN	0.3-1	0.01	100AMRD	30-100	1	-	-	-				0.15 x 1
AMRD2CN	0.5-2	0.025	200AMRD	50-200	2.5	AMRD3Z	1-3	0.05	93	26	# 0	0.2 x 1.5
AMRD4CN	1-4	0.05	400AMRD	100-400	5	AMRD6Z	2-6	0.1				0.3 x 2
AMRD8CN	2-8		800AMRD	200-800	10	AMRD12Z	3-12	0.2				
BMRD		0.1		kgf-cm	kgf-cm		lbf-in	lbf-in				
BMRD15CN2	2-15		1.5BMRD2	0.2-1.5	0.01	1.5BMRD2-A	0.2-1.5	0.005	116	50	-	-
BMRD30CN2	4-30	0.2	3BMRD2	0.4-3	0.02	3BMRD2-A	0.4-3	0.01				

Note 1. Bits for BMRD are sold separately. Refer to page 10.
2. Bits for AMRD are supplied from only Tohnichi.

AML D/BML D

Direction Adjustable Torque Screwdriver for Small Screws



AML D4CN



BML D30CN2

Assembly Adjustable Graduation ISO6789:2003

- Low torque version of LTD
- AML D includes Tohnichi original bits.

Accuracy ±3%

S.I. Model	Torque Range [cN-m]		Metric Model	Torque Range [gf-cm/kgf-cm]		American Model	Torque Range [ozf-in/lbf-in]		Overall Length [mm]	Weight [g]	Standard Accessory Bit	
	Min.-Max.	Grad.		Min.-Max.	Grad.		Min.-Max.	Grad.			⊕	⊖ Thickness x Width
AML D	cN-m	cN-m		gf-cm	gf-cm		ozf-in	ozf-in				
AML D1CN	0.3-1	0.01	100AML D	30-100	1	-	-	-				0.15 x 1
AML D2CN	0.5-2	0.025	200AML D	50-200	2.5	AML D3Z	1-3	0.05	83	26	# 0	0.2 x 1.5
AML D4CN	1-4	0.05	400AML D	100-400	5	AML D6Z	2-6	0.1				0.3 x 2
AML D8CN	2-8		800AML D	200-800	10	AML D12Z	3-12	0.2				
BML D		0.1		kgf-cm	kgf-cm		lbf-in	lbf-in				
BML D15CN2	2-15		1.5BML D2	0.2-1.5	0.01	1.5BML D2-A	0.2-1.5	0.005	116	50	-	-
BML D30CN2	4-30	0.2	3BML D2	0.4-3	0.02	3BML D2-A	0.4-3	0.01				

Note 1. Bits for BML D are sold separately. Refer to page 10.
2. Bits for AML D are supplied from only Tohnichi.

Daily Check and Calibration of Torque Screwdrivers

Digital Torque Gauges for Daily Inspections

One use of ATGE-G and BTGE-G digital torque gauges is to check the accuracy of small torque screwdrivers such as AML D/AMRD and BML D/BMRD. Monitoring drivers with daily inspections confirms driver function and accuracy prior to use. Refer to page 59 and 60.

- ATGE-G
- BTGE-G
- ATGE-G with Measurement stand, #808
- BTGE-G with Measurement stand, #809



Torque checking figure for AMRD with ATGE-G and measurement stand, #808.



Torque checking figure for BMRD with BTGE-G

Torque Driver Tester for Calibration and Adjustments

TDT3-G digital torque screwdriver testers are for the calibration of torque screwdrivers such as click type and indicating type. The loading device keeps the driver steady and in a vertical position during testing for highly accurate calibration and easy adjustments.

- TDT3-G: Refer to page 57.



Click type RTD with TDT3-G and loading device STA.



Indicating type FTD with TDT3-G and optional loading device LTA.

MNTD

Marking Torque Screwdriver

Direction



MNTD120CN



MNTD500CN

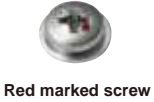

Red marked screw



Blue marked screw



Blue MNTD Marker



Auxiliary Tightening Tool for MNTD500CN



1601 MNTD Bit
1611 MNTD Bit

Assembly Preset ISO6789:2003

- Non-rotary preset type marking torque screwdriver
- Total 7 types of phillips and hexagon bits available
- Marking screws as torque is achieved

Accuracy ±3%

Model	Torque Range			Overall Length [mm]	Weight [g]
	[cN·m] Min.-Max.	[kgf·cm] Min.-Max.	[lbf·in] Min.-Max.		
MNTD120CN	40-120	4-12	4-10	150	210
MNTD260CN	100-260	10-26	10-22	152	315
MNTD500CN	200-500	20-50	20-40	168	365

- Note**
1. MNTD special designed bits and markers are sold separately.
 2. Tester is required to set/change a torque value.
 3. MNTD is not applicable with hexagon socket set screws.
 4. Dark colored screws might not be suitable to detect MNTD marking.

Standard Accessories Green resin grip for 120CN and 260CN. Auxiliary tightening tool for 500CN

MNTD Optional Accessories

MNTD Plus Bit

Part #	Model	Applicable Screw/Ref.
1601	MNTD #1 bit	M2.5, (M3)
1602	MNTD #2 bit	M3, M4, M5
1603	MNTD #3 bit	M6

MNTD Hex Bit

Part #	Model	Applicable Screw/Ref.
1611	MNTD W2.5 bit	M3
1612	MNTD W3 bit	M4
1613	MNTD W4 bit	M5
1614	MNTD W5 bit	M6

- Note**
1. Tohnichi special designed bit is required for MNTD.
 2. Applicable for screw that head diameter is over ø 5.5mm. Unavailable to hexagon set screws.
 3. In M3 screw, only binding head screw is applicable.

MNTD Marker

Part #	Model
1621	MNTD Marker Red 10 pcs/set
1622	MNTD Marker Red 100 pcs/set
1623	MNTD Marker Blue 10 pcs/set
1624	MNTD Marker Blue 100 pcs/set

- Note**
1. It is a disposable marker.
 2. 1 pc of marker are capable of 1000 marking operations.

Preset Hook Spanner for MNTD

Part #	Applicable Model
52	MNTD120CN
53	MNTD260CN
54	MNTD500CN

Note To set/change torque value.

RTDLS/RNTDLS

Direction



Rotary Slip Type Torque Screwdriver with Limit Switch

Accuracy ±3%

Assembly ISO6789:2003

- RTD/RNTD style with Limit Switch output
- Wired Error-Proofing, Pokayoke, system for assembly processes

S.I. Model	Torque Range [cN·m]		Metric Model	Torque Range [kgf·cm]		American Model	Torque Range [lbf·in]		Overall Length [mm]	Weight [g]
	Min.-Max.	Grad.		Min.-Max.	Grad.		Min.-Max.	Grad.		
RTDLS120CN	20-120	1	12RTDLS	2-12	0.1	RTDLS10I	2-10	0.1	184	340
RTDLS260CN	60-260	2	26RTDLS	6-26	0.2	RTDLS22I	6-22	0.2	201	450
RTDLS500CN	100-500	5	50RTDLS	10-50	0.5	RTDLS40I	10-40	0.5	212	540
RNTDLS120CN	40-120	-	-	4-12	-	-	4-10	-	166	320
RNTDLS260CN	100-260	-	-	10-26	-	-	10-22	-	167	390
RNTDLS500CN	200-500	-	-	20-50	-	-	20-40	-	175	480

- Note**
1. Bits are sold separately. Refer to page 10.
 2. RNTDLS models are required a torque driver tester for torque setting. Specify required torque when you order. Ex. RNTDLS120CN x 100cN·m
 3. Limit switch specifications AC30V below 1A, DC30V below 1A
 4. Female connector for LS cable is sold separately. Part# WA5219K.

POKA Patrol, Count Checker CNA-4mk3

Refer to page 27.



* Sold separately

RTDFH/RNTDFH

Direction



Rotary Slip Type Pokayoke Torque Screwdriver

Accuracy ±3%

Assembly ISO6789:2003

- Torque screwdriver with wireless error-proofing, Pokayoke, function
- High reliable FHSS technology with universal 2.4GHz frequency band

S.I. Model	Torque Range [cN·m]		Metric Model	Torque Range [kgf·cm]		American Model	Torque Range [lbf·in]		Overall Length [mm]	Weight [g]
	Min.-Max.	Grad.		Min.-Max.	Grad.		Min.-Max.	Grad.		
RTDFH120CN	20-120	1	12RTDFH	2-12	0.1	RTDFH10I	2-10	0.1	184	280
RTDFH260CN	60-260	2	26RTDFH	6-26	0.2	RTDFH22I	6-22	0.2	201	380
RTDFH500CN	100-500	5	50RTDFH	10-50	0.5	RTDFH40I	10-40	0.5	212	490
RNTDFH120CN	40-120	-	-	4-12	-	-	4-10	-	166	260
RNTDFH260CN	100-260	-	-	10-26	-	-	10-22	-	167	320
RNTDFH500CN	200-500	-	-	20-50	-	-	20-40	-	175	430

- Note**
1. RTDFH/RNTDFH are ESD/Electro Static discharge.
 2. Refer to page 30 for receiver and setting box.
 3. Contact to Tohnichi for condition of wireless equipment in each country.
 4. Auxiliary tightening tool for RTDFH/RNTDFH500CN is part # 32.

Standard Accessories Adjusting handle : RTDFH500CN and RNTDFH500CN

Transmitter Specifications

Model	RTDFH/RNTDFH
Frequency Band	2.4GHz band (2.402GHz~2.479GHz, 1MHz interval 78ch)
Communication System	Spread spectrum (FHSS)
Modulation System	GFSK
Modulation Rate	1Mbps
Group Channel	Gr 000~255
ID	3 digit (000~999), 7 digit (alphanumeric)
Input/Output	-
Power[V]	DV3V(CR2032)
Antenna	Chip Antenna
Display	LED
Operating Temperature	0~45 °C
Communication Distance	approx. 10~20m

Receiver R-FH256

Refer to page 29 for wireless Pokayoke system configuration.

*Sold separately



POKA Patrol, Count Checker CNA-4mk3

Refer to page 27.

* Sold separately



FTD

Dial Indicating Torque Screwdriver with Memory Pointer

Direction



FTD200CN2-S



FTD100CN

Inspection | Dial Indicating | Memory Pointer | Direct Reading | ISO6789:2003

- Ideal for measuring torque
- FTD-S with memory pointer; FTD with preset knob

S.I. Model	Torque Range [cN·m]		Metric Model	Torque Range [gf·cm/kgf·cm]		American Model	Torque Range [ozf-in/lbf-in]		Overall Length [mm]	Weight [g]	Standard Accessory Bit	
	Min.-Max.	Grad.		Min.-Max.	Grad.		Min.-Max.	Grad.			⊕	⊖ Thickness x Width
FTD-S	cN·m	cN·m		gf·cm	kgf·cm		ozf-in	lbf-in	152	140	Interchangeable bit is sold separately. Refer to page 11.	
FTD2CN-S	0.3-2	0.05	02FTD2-S	30-200	5	FTD3Z2-S	0.5-3	0.1				
FTD5CN-S	0.5-5	0.1	05FTD2-S	50-500	10	FTD7Z2-S	1-7	0.2				
FTD10CN-S	1-10	0.2	1FTD2-S	0.1-1	0.02	FTD15Z2-S	2-15	0.5				
FTD20CN-S	3-20	0.5	2FTD2-S	0.3-2	0.05	FTD30Z2-S	5-30	1				
FTD50CN2-S	5-50	1	5FTD2-S	0.5-5	0.1	FTD70Z2-S	10-70	2	272	370		
-	-	-	-	-	-	5FTD2-A-S	0.5-5	0.1				
FTD100CN2-S	10-100	2	10FTD2-S	1-10	0.2	10FTD2-A-S	1-10	0.2				
FTD200CN2-S	30-200	5	20FTD2-S	3-20	0.5	20FTD2-A-S	3-20	0.5				
FTD400CN2-S	50-400	10	40FTD2-S	5-40	1	40FTD2-A-S	5-40	1				
	N·m	N·m							338	900	# 3 1.2 x 8	
FTD8N2-S	1-8	0.2	80FTD2-S	10-80	2	80FTD2-A-S	10-70	2				
FTD16N2-S	3-16	0.5	160FTD2-S	30-160	5	160FTD2-A-S	20-140	5				
	cN·m	cN·m							215	285	# 1 0.7 x 7	
FTD50CN	10-50	1	5FTD	1-5	0.1	5FTD-A	1-5	0.1				
FTD100CN	20-100	2	10FTD	2-10	0.2	10FTD-A	1-10	0.2				
FTD200CN	40-200	5	20FTD	4-20	0.5	20FTD-A	3-20	0.5				
FTD400CN	80-400	10	40FTD	8-40	1.0	40FTD-A	5-40	1				

Note FTD8N2-S, FTD16N2-S: Square drive type, 6.35mm

Standard Accessories Auxiliary tightening bar for FTD8N2-S and FTD16N2-S

MTD

Micro Dial Indicating Torque Screwdriver

Direction

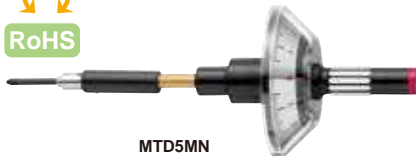

MTD5MN

Inspection | Dial Indicating | Direct Reading | ISO6789:2003

- Low torque capacity version of FTD
- Requires special size bits

S.I. Model	Torque Range [mN·m]		Metric Model	Torque Range [gf·cm]		American Model	Torque Range [ozf-in]		Overall Length [mm]	Weight [g]	Standard Accessory Bit	
	Min.-Max.	Grad.		Min.-Max.	Grad.		Min.-Max.	Grad.			⊕	⊖ Thickness x Width
MTD5MN	0.5-5	0.1	50MTD	5-50	1	MTD07Z	0.1-0.7	0.02	100	21	# 0 0.15 x 1	
MTD10MN	1-10	0.2	100MTD	10-100	2	MTD1.4Z	0.2-1.4		132	23	# 0 0.2 x 1.5	
											0.3 x 2	

Note MTD models require Tohnichi made bits. Refer to page 10.

STC2-G/-BT

Digital Torque Screwdriver

Direction



STC200CN2-G

Assembly | Inspection | Digital | Direct Reading | Ratchet | ISO6789:2003

- Ideal for tightening and inspection operation
- 1000 data memory storage and data output function
- Color LED indicator, White, Blue, Yellow, and Red

Model	Torque Range								Overall Length [mm]	Weight [g]	
	[cN·m]		[kgf·cm]		[lbf-in]		[ozf-in]				
Standard Version	Bluetooth® Version	Min.-Max.	1digit	Min.-Max.	1digit	Min.-Max.	1digit	Min.-Max.	1digit	230	325
STC50CN2-G	STC50CN2-G-BT	10-50	0.05	1-5	0.005	1-4.4	0.005	15-70	0.05		
STC200CN2-G	STC200CN2-G-BT	40-200	0.2	4-20	0.02	4-17	0.02	-	-		
STC400CN2-G	STC400CN2-G-BT	80-400	0.5	8-40	0.05	8-35	0.05	-	-		

- Note
1. Bits are sold separately. Refer to page 10.
 2. Bits size as below
 3. Display can be turned upside down with keypad operation.
 4. Data output of standard version is through USB only.
 5. Data output of Bluetooth® version is through USB and Bluetooth®.
 6. Contact to Tohnichi for condition of wireless equipment in each country.

Standard Accessories USB cable/384, AC adapter/BA-7, and Battery pack/BP-7. Refer to page 50.

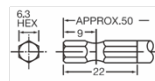

White LED light
80% of target torque



Blue LED light
Achieving target torque



Yellow & Red flashing LED light
Over torque indication

* Bluetooth is a registered trademark of Bluetooth SIG, Inc.

STC2-G/-BT Specifications

Accuracy	±1%
Measurement Mode	Tightening / Inspection mode
Battery Indicator	4 levels
Judgment Mode	Buzzer and LED indicator on upper/lower limit
Basic Functions	Auto-power off, Auto memory & reset, Auto zero setting
Power Supply	Lithium Ion Battery
Data Output	USB
Operating Time	approximate 30 hours
Recharging Time	AC adaptor: 5 hours USB through PC: 10 hours

STC2-G-BT Communication Specifications

Bluetooth® Version	V3.0
Transmitting System	AFH
Modulation System	GFSK
Wireless Output	4dBm
Transmission Power Class	Class 2
Profile	SPP
Communication Distance	10m
Operating Time	15 hours

[EX.] Torque checking figure for torque screwdriver



STC2-G

Interchangeable Bit

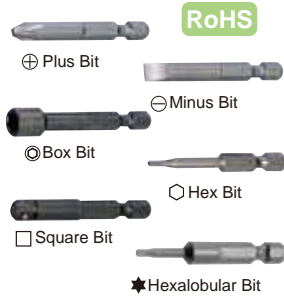

Torque Screwdriver	Root Shape						
	U30CN	U (except U30CN)			-	-	-
Power Torque Tool	-						
Root Shape Sign	A	B	C	D	F	G	H
RTD/RTD/LTD BMRD BMLD FTD50CN - 400CN FTD2CN-S - 400CN2-S STC2-G	FTD8N2-S - FTD16N2-S, (FTD8N - 16N)	AMRD AMLD MTD	LTD2000CN				
Root Shape and Dimensions							

Screw Head Shape	Sign	Size	Screw	Tohnichi Original Bit		Common (Standard)		Tohnichi Original Bit		Common (Standard)		
				Tohnichi Original Bit	Tohnichi Original Bit	Tohnichi Original Bit	Tohnichi Original Bit	Tohnichi Original Bit	Tohnichi Original Bit			
Plus	⊕	0	#0 (S-0)	Refer to Table A	104		109					
		1	#1 (H-1)	Refer to Table A		85	106	84	116			
		2	#2 (H-2)	Refer to Table A		86	107	80				
		3	#3 (H-3)	Refer to Table A		87		81		35	700	
		4	#4 (H-4)	Refer to Table A						36		
	Minus	⊖	10	0.15 x 1	Refer to Table B					111		
			11	0.2 x 1.5	Refer to Table B					112		
			12	0.3 x 2	Refer to Table B					113		
			13	0.4 x 2.4	Refer to Table B	105						
			14	0.6 x 3.8	Refer to Table B			108				
			15	0.7 x 7	Refer to Table B		88					
			16	0.9 x 7	Refer to Table B		89					
			17	1 x 10	Refer to Table B							37
			18	1 x 12	Refer to Table B							38
			19	1.2 x 17	Refer to Table B							39
			20	1.6 x 10	Refer to Table B					82		
	21	1.2 x 8	Refer to Table B					83				
	Hex bit socket	⊙	Hex Bolt									
			W 5.5	5.5	M3		91					
			W 6	6	(M3.5)		95					
			W 7	7	M4		92					
W 8			8	(M4.5) M5		93						
W 10	10	M6		94								
Hex	⬡	Cap Screw		Set Screw								
		W 1.27	1.27		M2.5		56					
		W 1.5	1.5		M3		57					
		W 2	2	M2.5	M4		58					
		W 2.5	2.5	M3	M5		59					
		W 3	3	M4	M6		60					
		W 4	4	M5	M8		61					
		W 5	5	M6	M10		62					
		W 6	6	M8	M12 (M14)		63					
W 8	8	M10	M16 (M18)		64							
Square Drive	□	2	□ 6.35 (1/4)							33		
		3	□ 9.53 (3/8)							34		
Hexalobular	★	Flat Head		Socket Head	Set Screw							
		T 5	M2		M2.5		470					
		T 6	M2		M3		471					
		T 7			M3.5							
T 8	M2.5	M2.5	M4		472							

Bolt Head Shape * Reference

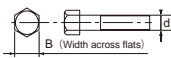

Nominal Size of Screw (d)	Hex head Bolt (B)	Small Hex Head Bolt (B)	High Strength Hex Bolt for Friction Grip Joint (B)	Hex Socket Head Cap Screw (B)	Hex Socket Set Screw (B)
M2.5	4.5	-	-	2	1.27
M3	5.5	-	-	2.5	1.5
(M3.5)	6	-	-	-	-
M4	7	-	-	3	2
(M4.5)	8	-	-	-	-
M5	8	-	-	4	2.5
M6	10	-	-	5	3
(M7)	11	-	-	-	-
M8	13	12	-	6	4
M10	16	17	14	8	5
M12	18	19	17	10	6
(M14)	21	22	19	12	-
M16	24	22	27	14	8
(M18)	27	24	-	-	-
M20	30	27	32	17	10
(M22)	32	34	30	19	-
M24	36	32	41	-	-
(M27)	41	36	46	-	-
M30	46	41	50	22	-
(M33)	50	46	-	24	-
M36	55	50	-	27	-
(M39)	60	55	-	-	-
M42	65	-	-	32	-
JIS	JIS B 1180	JIS B 1180	JIS B 1186	JIS B 1176	JIS B 1177

Hex Bolt

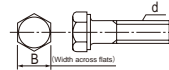

Cap Screw

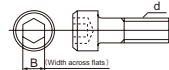

Set Screw

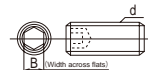

Flat Head Screw

How to order :

Indicate the model name and catalog No.

EX. MODEL NAME CATALOG No.

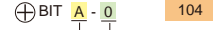

Root Shape Sign

Point Shape Sign

Size of Bits

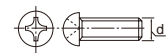

Table A

No. of Cross Nominal Size of Screw (d)	Hole No.	Remark
M1.6, M2	#0 (S-0)	
[M2], (M2.2), M2.5, (M3)	#1 (H-1)	Pan head screw, Flat head screw, Pan flat screw, Bind screw
M3, (M3.5), M4, (M4.5), M5	#2 (H-2)	[(M3) #1 is bind small screw only]
M6	#3 (H-3)	[(M2) #1 is not compliant with ISO]
M8, M10	#4 (H-4)	

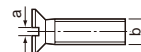

Table B

Groove Width (a)	ISO screws	Nominal Size (b)																		
		M1	M1.2	(M1.4)	M1.6	(M1.7)	M2	(M2.2)	M2.3	M2.5	(M2.6)	M3	(M3.5)	M4	(M4.5)	M5	M6	M8	M10	
		0.4	0.5	0.6	0.8	1	1.2	1.2	1.6	2	2.5									
	Non-ISO screws	0.32	0.4	0.6	0.8	1	1.2	1.6												



QL/QLE2

Ratchet Head Type Adjustable Torque Wrench

Assembly Adjustable Ratchet Head Graduation ISO6789:2003/2017

- Basic adjustable click style with resin grip
- Torque value easily set with external scale and knob

Direction



Accuracy ±3%

QL/QL-MH Optional Accessories



Carrying Case (P.49)

Part #	Applicable Model Dimension [mm]
842	QL50N, QL50N-MH, QL100N4-MH H60 x W400 x D70
843	QL140N, QL140N-MH, QL200N4, QL200N4-MH H60 x W520 x D80
846	QL140N, QL140N-MH and below H170 x W500 x D100
847	QL280N, QL280N-MH and below H170 x W740 x D100

S.I. Model	Torque Range [N·m]		Metric Model	Torque Range [kgf·cm/kgf·m]		American Model	Torque Range [lbf·in/lbf·ft]		Overall Length [mm]	Square Drive [mm]	Weight [kg]
	Min.-Max.	Grad.		Min.-Max.	Grad.		Min.-Max.	Grad.			
QL	N·m	N·m		kgf·cm	kgf·cm		lbf·in	lbf·in			
QL2N	0.4-2	0.02	20QL	4-20	0.2	QL15I-2A	3-15	0.1	194		0.27
QL5N	1-5	0.05	50QL	10-50	0.5	QL30I-2A	6-30	0.2			
QL10N	2-10	0.1	100QL	20-100	1	QL50I-2A	10-50	0.5	219	6.35	0.29
QL15N	3-15		150QL	30-150		QL100I-2A	20-100	1			
QL25N5-1/4	5-25	0.2	225QL5-1/4	50-250	2.5	QL200I-2A	40-200	2.5	237		0.33
QL25N5			225QL5			QL200I-3A					
QL50N	10-50	0.5	450QL3	100-500	5	QL400I-3A	100-400	5	260		0.45
	-	-	-	-	-	QL750I-3A	150-750	10		9.53	
QL100N4-3/8	20-100	1	900QL4-3/8	200-1000	10	QL75F-3A	15-75	1	335		0.69
QL100N4	20-100		900QL4	200-1000		QL100F-4A	30-100	1	400		0.88
QL140N	30-140	20	1400QL3	300-1400	20	QL150F-4A	30-150		490	12.7	1.4
QL200N4	40-200		1800QL4	400-2000		QL200F-4A	30-210	2	695		2.0
QL280N-1/2	40-280	2	2800QL3-1/2	4-28	0.2	QL300F-6A	60-300		995		3.4
QL280N			2800QL3	QL2800N2		80-280	2	1189	4.3		
QL420N	60-420		4200QL2	6-42		1515	7.7				
QLE2	N·m	N·m		kgf·m	kgf·m		lbf·ft	lbf·ft		19.05	
QLE550N2	100-550	5	5500QLE2	10-55	0.5	QLE400F-6A	100-400		1342	5.6	
QLE750N2	150-750		7500QLE2	15-75		QLE600F-6A	150-600	5	1895	14.6	
QLE1000N2	200-1000	10	10000QLE2	20-100	1	QLE700F-8A	200-700		2405	38.1	23.7
QLE1400N2	300-1400		14000QLE2	30-140		QLE1000F-8A	300-1000	10	1787	25.4	
QLE2100N2	500-2100		21000QLE2	50-210		QLE1500F-8A	500-1500				
QLE2800N2	800-2800	20	28000QLE2	80-280	2	QLE2000F-12A	600-2000	20			

- Note
1. QL2N-QL25N5 are yellow/black resin grips. QL50N-QL280N are black resin grips.
 2. QL420N and QLE550N2-QLE2800N2 are knurled handles.
 3. Use a through-hole socket for square drive over 25.4mm.
 4. QL2N, QL5N and the equivalent metric models, American models comes with ISO:6789-2003 cert.



Part #	Color	Applicable Model
879	Red	QL2N, QL5N
880	Blue	QL10N, QL15N, QL25N5-1/4, QL25N5
881	Green	
882	Black	



QL Protective Head Cover (P.49)

Part #	Applicable model
870	QL2N(-MH) - 15N(-MH)
871	QL25N5, QL25N-MH
872	QL50N(-MH)
873	QL100N4(-MH)
874	QL140N(-MH)
875	QL200N4(-MH)
877	QL280N(-MH)
878	QSP420N

QLLS RoHS

- QL style with Limit Switch output
- Wired Error-Proofing, Pokayoke, system for assembly processes



S.I. Model	Metric Model
QLMS2N-MH	20QLMS-MH
QLMS5N-MH	50QLMS-MH
QLMS10N-MH	100QLMS-MH
QLMS10N	100QLMS
QLMS15N	150QLMS
QLMS15N-MH	150QLMS-MH
QLLS25N5	225QL5LS
QLLS50N	450QL3LS
QLLS100N4	900QL4LS
QLLS140N	1400QL3LS
QLLS200N4	1800QL4LS
QLLS280N	2800QL3LS
QLLS420N	4200QL2LS

POKA Patrol, Count Checker CNA-4mk3

Refer to page 27.



* Sold separately

QL-MH

Ratchet Head Type Adjustable Torque Wrench with Metal Handle

Assembly Adjustable Ratchet Head Graduation ISO6789:2003/2017

- Knurled metal handle version of QL
- Ideal for oily working conditions

Direction



Accuracy ±3%

S.I. Model	Torque Range [N·m]		Metric Model	Torque Range [kgf·cm/kgf·m]		American Model	Torque Range [lbf·in]		Overall Length [mm]	Square Drive [mm]	Weight [kg]
	Min.-Max.	Grad.		Min.-Max.	Grad.		Min.-Max.	Grad.			
QL2N-MH	0.4-2.0	0.02	20QL-MH	4-20	0.2	QL15I-2A-MH	3-15	0.1	160		0.16
QL5N-MH	1-5	0.05	50QL-MH	10-50	0.5	QL30I-2A-MH	6-30	0.2			
QL10N-MH	2-10	0.1	100QL-MH	20-100	1	QL50I-2A-MH	10-50	0.5	195	6.35	0.19
QL15N-MH	3-15		150QL-MH	30-150		QL100I-2A-MH	20-100	1			
QL25N-MH	5-25	0.25	225QL-MH	50-250	2.5	-	-	-	230		0.25
QL50N-MH	10-50	0.5	450QL-MH	100-500	5	-	-	-	260		0.45
QL100N4-MH	20-100	1	900QL4-MH	200-1000	10	-	-	-	335		0.69
QL140N-MH	30-140		1400QL-MH	300-1400		-	-	-	400	12.7	0.88
QL200N4-MH	40-200	2	1800QL4-MH	400-2000	20	-	-	-	490		1.4
			2800QL-MH	4-28		0.2	-	-	-	695	19.05

- Note
1. QL2N-MH, QL5N-MH and the equivalent metric models, American models comes with ISO:6789-2003 cert.

CL/CLE2

Interchangeable Head Type Adjustable Torque Wrench

Direction



Interchangeable Head

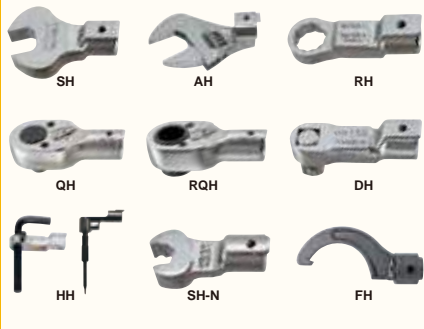

CL/CL-MH Optional Accessories



Carrying Case (P.49)

Part #	Applicable Model Dimension [mm]
842	CL50N×12D/15D, CL50N×12D/15D-MH, CL100N×15D-MH H60 × W400 × D70
843	CL140N×15D/-MH, CL200N×19D/-MH H60 × W520 × D80
846	CL200N×19D, CL200N×19D and below H170 × W500 × D100
847	CL280N×22D, CL280N×22D-MH and below H170 × W740 × D100



Color Cap

Part #	Color	Applicable Model
879	Red	CL2N×8D, CL5N×8D CL10N×8D, CL15N×8D CL25N×10D
880	Blue	
881	Green	
882	Black	

Assembly Adjustable Interchangeable Graduation ISO6789:2003/2017

- Interchangeable Head can be easily exchanged.
- Torque value easily set with external scale and knob

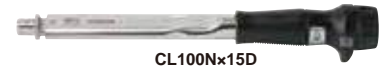

Head Size	S.I. Model	Torque Range [N-m]		Metric Model	Torque Range [kgf-cm/kgf-m]		American Model	Torque Range [lbf-in/lbf-ft]		Overall Length [mm]	Weight [kg]
		Min.-Max.	Grad.		Min.-Max.	Grad.		Min.-Max.	Grad.		
8D	CL	N-m	N-m	20CL	kgf-cm	kgf-cm	CL151x8D	lbf-in	lbf-in	174	0.24
	CL2N×8D	0.4-2	0.02	50CL	4-20	0.2	CL301x8D	3-15	0.1		
	CL5N×8D	1-5	0.05	100CL	10-50	0.5	CL501x8D	6-30	0.2		
	CL10N×8D	2-10	0.1	150CL	20-100	1	CL1001x8D	10-50	0.5		
10D	CL15N×8D	3-15	0.1	500CL3	30-150	5	CL2001x10D	20-100	1	199	0.26
	CL25N5×10D	5-25	0.2	225CL5	50-250	2.5	500CL3-A	100-400	5		
12D	CL50N×12D	10-50	0.5	450CL3	100-500	5	CL501x8D	100-450	5	230	0.37
	CL50N×15D			900CL3			200-1000				
15D	CL100N×15D	20-100	1	1400CL3	300-1400	10	1400CL3-A	30-100	1	370	0.67
	CL140N×15D	30-140	2	1800CL3	400-2000	20	1800CL3-A	30-150	2		
19D	CL200N×19D	40-200	2	2800CL3	4-28	0.2	2800CL3-A	30-200	2	455	1.2
	CL280N×22D	40-280	2	4200CL2	6-42	0.2	4200CL2-A	60-300	2		
22D	CL420N×22D	60-420	5	5500CLE2	10-55	0.5	5500CLE2-A	100-400	5	655	1.8
	CLE2	N-m	N-m	7500CLE2	15-75	0.5	7500CLE2-A	150-550	5		
27D	CLE550N2×27D	100-550	5	8500CLE2	20-85	5	8500CLE2-A	150-600	5	1148	3.9
	CLE750N2×27D	150-750	5	12000CLE2	30-120	5	12000CLE2-A	200-900	5		
32D	CLE850N2×32D	200-850	5	CLE1200N2×32D	300-1200	5	CLE400F×27D	100-400	5	1291	4.9
	CLE1200N2×32D	300-1200	5	CLE600F×32D	150-600	5	CLE900F×32D	200-900	5		

- Note
1. Overall length does not include interchangeable head. Interchangeable heads are optional.
 2. PH type interchangeable head/p.48 is not applicable.
 3. CL2N - CL25N5 are yellow/black resin grips. CL50N - CL280N are black resin grips.
 4. CL420N and CLE550N2-CLE1200N2 are knurled handles.
 5. CL2N×8D, CL5N×8D and the equivalent metric models, American models comes with ISO:6789-2003 cert.

CLLS

RoHS

- CL style with Limit Switch output
- Wired Error-Proofing, Pokayoke, system for assembly processes

S.I. Model	Metric Model
CLMS2N×8D-MH	20CLMS-MH
CLMS5N×8D-MH	50CLMS-MH
CLMS10N×8D-MH	100CLMS-MH
CLMS10N×8D	100CLMS
CLMS15N×8D	150CLMS
CLMS15N×8D-MH	150CLMS-MH
CLLS25N5×10D	225CL5LS
CLLS50N×12D	450CL3LS
CLLS50N×15D	500CL3LS
CLLS100N×15D	900CL3LS
CLLS140N×15D	1400CL3LS
CLLS200N×19D	1800CL3LS
CLLS280N×22D	2800CL3LS
CLLS420N×22D	4200CL2LS

POKA Patrol, Count Checker CNA-4mk3

Refer to page 27.



* Sold separately

CL-MH

Interchangeable Head Type Adjustable Torque Wrench with Metal Handle

Direction



CL5N×8D-MH



CL100N×15D-MH

Assembly Adjustable Interchangeable Graduation ISO6789:2003/2017

- Knurled metal handle version of CL
- Ideal for oily working conditions

Head Size	S.I. Model	Torque Range [N-m]		Metric Model	Torque Range [kgf-cm/kgf-m]		American Model	Torque Range [lbf-in]		Overall Length [mm]	Weight [kg]
		Min.-Max.	Grad.		Min.-Max.	Grad.		Min.-Max.	Grad.		
8D	CL	N-m	N-m	20CL-MH	kgf-cm	kgf-cm	CL151x8D-MH	lbf-in	lbf-in	140	0.13
	CL2N×8D-MH	0.4-2	0.02	50CL-MH	4-20	0.2	CL301x8D-MH	3-15	0.1		
	CL5N×8D-MH	1-5	0.05	100CL-MH	10-50	0.5	CL501x8D-MH	6-30	0.2		
	CL10N×8D-MH	2-10	0.1	150CL-MH	20-100	1	CL1001x8D-MH	10-50	0.5		
10D	CL15N×8D-MH	3-15	0.1	500CL-MH	30-150	5	CL2001x8D-MH	20-100	1	175	0.16
	CL25N×10D-MH	5-25	0.25	225CL-MH	50-250	2.5	-	-	-		
12D	CL50N×12D-MH	10-50	0.5	450CL-MH	100-500	5	-	-	-	230	0.37
	CL50N×15D-MH			900CL-MH			200-1000	900CL-MH	200-800		
15D	CL100N×15D-MH	20-100	1	1400CL-MH	300-1400	10	-	-	-	370	0.67
	CL140N×15D-MH	30-140	2	1800CL-MH	400-2000	20	-	-	-		
19D	CL200N×19D-MH	40-200	2	2800CL-MH	4-28	0.2	-	-	-	455	1.2
	CL280N×22D-MH	40-280	2	4200CL-MH	6-42	0.2	-	-	-		
22D	CL420N×22D-MH	60-420	5	5500CL-MH	10-55	0.5	-	-	-	655	1.6

- Note
1. Overall length does not include interchangeable head.
 2. PH type interchangeable head/p.48 is not applicable.
 3. Interchangeable heads are optional.
 4. CL2N×8D-MH, CL5N×8D-MH and the equivalent metric models, American models comes with ISO:6789-2003 cert.

Torque Wrench for Assembly

DQL/DQLE2

Direction

Dual Square Drives
Type Adjustable Torque
Wrench



RoHS

Assembly Adjustable Ratchet Head Graduation Bi-Directional ISO6789:2017

- For bi-directional tightening
- Ideal for tightening large vehicle tires



DQL200N4



DQLE750N2

Accuracy ±3%

S.I. Model	Torque Range [N-m]		Metric Model	Torque Range [kgf-cm/kgf-m]		American Model	Torque Range [lbf-ft]		Overall Length [mm]	Square Drive [mm]	Weight [kg]
	Min.-Max.	Grad.		Min.-Max.	Grad.		Min.-Max.	Grad.			
DQL	N-m	N-m		kgf-cm	kgf-cm						
DQL200N4	40-200		1800DQL4	400-2000	20	1800DQL4-A	30-150		490	12.7	1.4
DQL280N	40-280	2	2800DQL3	4-28	0.2	2800DQL3-A	30-200		695		2.0
DQLE2	N-m	N-m		kgf-m	kgf-m		lbf-ft	lbf-ft		19.0	
DQLE550N2	100-550		5500DQLE2	10-55		DQLE400F-6A	100-400		1189		4.4
DQLE750N2	150-750	5	7500DQLE2	15-75	0.5	DQLE600F-6A	150-600	5	1342		5.7
DQLE1000N2	200-1000		10000DQLE2	20-100		DQLE700F-8A	200-700		1515	25.4	7.9

- Note
1. DQL200N4 and DQL280N have resin grips.
 2. For the model having 25.4mm square drive, use a through-hole socket.
 3. DQLE550N2-DQLE1000N2 have knurled handles.
 4. DQLE2 with built-in Adjusting Handle

DQL200N4 Optional Accessories

Carrying Case (P.49)

Part #	Applicable Model Dimension [mm]	Weight [kg]
843	DQL200N4 H60 x W520 x D80	0.36
847	DQL280N and below H170 x W740 x D100	1.0

Protective Head Cover

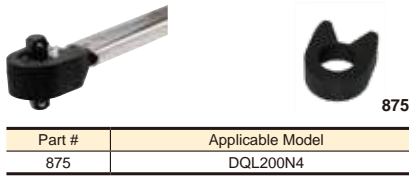

875

Part #	Applicable Model
875	DQL200N4

TW2

Adjustable Torque Wrench with Multiplier

Direction



RoHS

Assembly Adjustable Ratchet Head Graduation Bi-Directional

- Easy bolt tightening for large vehicle tires

Accuracy ±5%

Model	Torque Range [N-m]		Square Drive [mm]	Weight [kg]	
	Min.-Max.	Grad.		Body	Torque Wrench
TW750N2	350-750		25.4	20	1.5
TW1000N2	400-1000	5			2.0

- Note
1. TW2 is a set of dedicated torque wrench and stand. Standard torque wrench cannot be used.
 2. Use through hole type socket for square drive 25.4mm.
 3. Socket, pin, and O-ring are sold separately.
 4. Applicable height of nut is between 255 and 790mm

Usage Example



TW750N2

MTQL

Torque Wrench for Motorsports

Direction



RoHS

Assembly Adjustable Ratchet Head Graduation

- Wide capacity adjustable style
- Ideal for motorcycle & motorbike maintenance

Accuracy ±5%

S.I. Model	Torque Range [N-m]		Metric Model	Torque Range [kgf-m]		Overall Length [mm]	Square Drive [mm]	Weight [kg]
	Min.-Max.	Grad.		Min.-Max.	Grad.			
MTQL40N	5-40	0.5	400MTQL	0.5-4	0.05	250		0.45
MTQL70N	10-70		700MTQL	1-7		285	9.5	0.47
MTQL140N	20-140	1	1400MTQL	2-14	0.1	400	12.7	0.77

Standard Accessories Carrying case

MTQL Optional Accessories



842

846

Carrying Case (P.49)

Part #	Applicable Model Dimension [mm]	Weight [kg]
842	MTQL40N, MTQL70N H60 x W400 x D70	0.25
843	MTQL140N H60 x W520 x D80	0.36
846	MTQL140N and below H170 x W500 x D100	1.0

TiQL/TiQLE

Direction

Titanium Type Adjustable Torque Wrench



Assembly	Pre-Lock	Ratchet Head	Graduation	Titanium Material	ISO6789:2017
----------	----------	--------------	------------	-------------------	--------------

- 50% lighter than standard wrenches
- Ideal for working overhead

S.I. Model	Torque Range [N·m]		Metric Model	Torque Range [kgf·cm/kgf·m]		Overall Length [mm]	Square Drive [mm]	Weight [kg]
	Min.-Max.	Grad.		Min.-Max.	Grad.			
TiQL								
TiQL180N	40-180	2	1800TiQL	400-1800	20	494	12.7	0.9
TiQL180N			1800TiQL			594		1.0
TiEQLE360N	80-360		3600TiEQLE	kgf-m	kgf-m	987	19.0	2.4
TiEQLE	N-m	N-m		8-36	0.2			
TiEQLE750N	100-750	5	7500TiEQLE	kgf-m	kgf-m	1365		4.5
TiEQLE1400N	200-1400	10	14000TiEQLE	10-75	0.5	1794	25.4	7.5

Note For the model having 25.4mm square drive, use a through-hole socket.

- Standard Accessories
1. Hex key and Color bands for TiQL180N, TiQL180N and TiEQLE360N
 2. Adjusting tool for TiEQLE750N, TiEQLE1400N

TiEQLE Optional Accessories



Adjusting Tool for TiEQLE (P.49)

Part #	Applicable Model
301	TiEQLE750N, 1400N

TiQLLS



- TiQL style with Limit Switch output
- Wired Error-Proofing, Pokayoke, system for assembly processes

S.I. Model	Metric Model
TiQLLS180N	1800TiQLLS
TiQLLS180N	1800TiQLLS
TiQLLS360N	3600TiEQLLS

POKA Patrol, Count Checker CNA-4mk3

Refer to page 27.



* Sold separately

PHL/PHLE2

Direction

Pipe-Wrench Head Type Adjustable Torque Wrench



Assembly	Adjustable	Graduation	Pipe-Wrench Head
----------	------------	------------	------------------

- Ideal for use with pipes and plumbing applications

S.I. Model	Torque Range [N·m]		Metric Model	Torque Range [kgf·cm/kgf·m]		American Model	Torque Range [lbf-in/lbf-ft]		Grippable Pipe Dia. [mm]	Overall Length [mm]	Weight [kg]
	Min.-Max.	Grad.		Min.-Max.	Grad.		Min.-Max.	Grad.			
PHL											
PHL50N	10-50	0.5	500PHL3	kgf-cm	kgf-cm	450PHL3-A	lbf-in	lbf-in		316	1.46
PHL100N	20-100	1	900PHL3	100-500	5	900PHL3-A	15-75	lbf-ft		472	1.61
PHL140N	30-140		1400PHL3	400-1400	10	1400PHL3-A	30-100	1	13-38	530	1.76
PHL200N	40-200	2	1800PHL3	400-1800	20	1800PHL3-A	30-150			620	2.3
PHL280N	40-280		2800PHL3	4-28	kgf-m	kgf-m	2800PHL3-A	30-200	2		833
PHL420N	60-420	3	4200PHL	6-42	0.2	4200PHL-A	60-300			1122	4.83
PHLE2	N-m	N-m		kgf-m	kgf-m		lbf-ft	lbf-ft			
PHLE850N2	200-850	5	8500PHLE2	20-85	0.5	PHLE600F	150-600		26-52	1664	8.2
PHLE1300N2	300-1300		13000PHLE2	30-130		PHLE900F	200-900	5		1831	10

- Note
1. PHLE2 Models have extension bar handle.
 2. PHL420N, PHLE850N2, and PHLE1300N2 have knurled handles.
 3. PHLE2 with built-in Adjusting Handle

QRSP

Open Ring Head Type Preset Torque Wrench

Direction

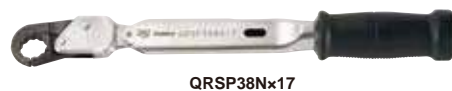

Assembly	Preset	Open Ratchet Head	ISO6789:2017
----------	--------	-------------------	--------------

- Ring head opens to allow fitting on tubes or pipes.

Model	Torque Range		Overall Length [mm]	Weight [kg]
	[N·m]	[kgf·cm]		
QRSP38Nx17	10-45	100-450	300	0.4
QRSP38Nx19			305	
QRSP38Nx21			310	
QRSP38Nx24			310	

Note A torque wrench tester is necessary for torque setting. Specify required set torque when you order. Ex. QRSP38Nx17 x 25N-m

QRSP Optional Accessories

Thrusting Tool for QRSP (P.49)

Part #	Tool #	Applicable Model
312	A-3	QRSP38N

QRSPLS



- QRSP style with Limit Switch output
- Wired Error-Proofing, Pokayoke, system for assembly processes

Model	Weight [kg]
QRSPLS38Nx17	0.4
QRSPLS38Nx19	
QRSPLS38Nx21	
QRSPLS38Nx24	

POKA Patrol, Count Checker CNA-4mk3

Refer to page 27.



* Sold separately

Torque Wrench for Assembly

PQL

Ratchet Head Type
Pre-Lock Torque
Wrench

Direction



RoHS

Assembly Pre-Lock Ratchet Head Graduation ISO6789:2017

- External scale, set by a hex key



PQL100N4

Accuracy ±3%

S.I. Model	Torque Range [N·m]		Metric Model	Torque Range [kgf·cm/kgf·m]		American Model	Torque Range [lbf·in/lbf·ft]		Overall Length [mm]	Square Drive [mm]	Weight [kg]
	Min.-Max.	Grad.		Min.-Max.	Grad.		Min.-Max.	Grad.			
PQL10N	2-10	0.1	100PQL	kgf·cm	kgf·cm	PQL50L-2A	lbf·in	lbf·in	190	6.35	0.19
PQL15N	3-15		150PQL	20-100	1	PQL100L-2A	10-50	0.5			
PQL25N	5-25	0.25	225PQL	50-250	2.5	225PQL-A	40-200	2	215	9.53	0.25
PQL50N	10-50	0.5	450PQL	100-500	5	450PQL-A	100-400	5	260		
PQL100N4	20-100	1	900PQL4	200-1000	10	900PQL4-A	lbf·ft	lbf·ft	320	12.7	0.65
PQL140N	30-140		1400PQL	300-1400		1400PQL-A	30-100	1			
PQL200N4	40-200	2	1800PQL4	400-2000	20	1800PQL4-A	30-150	2	470	19.05	1.40
PQL280N	40-280		2800PQL	4-28		-	-	-	670		
PQL420N	60-420		4200PQL	6-42	0.2	-	-	-	975	3.4	

Standard Accessories Hex key for torque adjustment

PQL Optional Accessories



Carrying Case (P.49)

Part #	Applicable Model Dimension [mm]	Weight [kg]
842	50N-100N4 H60 × W400 × D70	0.25
843	140N-200N4 H60 × W520 × D80	0.36
846	200N and below H170 × W500 × D100	1.0
847	280N and below H170 × W740 × D100	0.36

PQL Protective Head Cover (P.49)

PQLLS

RoHS

- PQL style with Limit Switch output
- Wired Error-Proofing, Pokayoke, system for assembly processes

Refer to page 28.

POKA Patrol, Count Checker
CNA-4mk3

Refer to page 27.

PQLZ

Pre-Lock Adjustable
Insulated Torque
Wrench

Direction



PQLZ100N4

Assembly Pre-Lock Graduation Vinyl Coating Insulated ISO6789:2017

- Insulated casing prevents electrical shocks.
- Specialized version of PQL

Accuracy ±3%

S.I. Model	Torque Range [N·m]		Metric Model	Torque Range [kgf·cm]		Overall Length [mm]	Square Drive [mm]	Weight [kg]
	Min.-Max.	Grad.		Min.-Max.	Grad.			
PQLZ25N	5-25	0.25	225PQLZ	50-225	2.5	227	9.5	0.28
PQLZ100N4	20-100	1	900PQLZ4	200-900	10	340	12.7	0.80

Standard Accessories Hex key for torque adjustment

Preset Insulated Torque Wrench

Direction



QSPZ25N

Assembly Preset Vinyl Coating Insulated ISO6789:2017

- Insulated design suited for use in electric shock hazard conditions
- Ideal for electric car assembly, connection of battery terminal wiring work etc.

Accuracy ±3%

Model	Torque Range			Overall Length [mm]	Square Drive [mm]	Weight [kg]
	[N·m]	[kgf·cm]	[lbf·in]			
	Min.-Max.	Min.-Max.	Min.-Max.			
QSPZ25N	5-25	50-250	50-200	227	9.5	0.28
QSPZ100N4	20-100	200-1000	100-750	334	12.7	0.8

Note 1. A torque wrench tester is necessary for torque adjustment. Specify required set torque when you order.
2. Adjusting tools for QSPZ are sold separately.
3. Sockets are sold separately. Refer to page 44.
4. Sockets are not insulation coating.

CLWP

Water Proof and
Dust Free Torque
Wrench

Direction



RoHS



CLWP50NX12D

Assembly Pre-Lock Interchangeable Water/Dust Proof ISO6789:2017

- Waterproof and Dustproof torque wrench meets IP55/IP57 rating
- Washable torque wrench
- Anticorrosion coating

Accuracy ±4%

Head Size	Model	Torque Range [N·m]		Overall Length [mm]	Weight [kg]
		Min.-Max.	Grad.		
10D	CLWP15NX10D	5-15	0.25	220.5	0.3
	CLWP25NX10D	10-25			
12D	CLWP50NX12D	20-50	0.5	243	0.5
	CLWP100NX15D	40-100	1	333.5	0.7
15D	CLWP140NX15D	60-140		2	378.5
	CLWP200NX19D	80-200	457.5		1.4

Note

- Overall length does not include interchangeable head.
- PH type interchangeable head/p.48 is not applicable.
- Interchangeable heads are optional. Refer to page 45-48.
- Waterproof and dustproof test meets IP55/IP57 by in-house test.

CLWP Optional Accessories

CPQH

Corrosion-resistant
interchangeable ratchet head



CPQH12D

PCL

Interchangeable Head Type Pre-Lock Torque Wrench

Direction



RoHS

Interchangeable Head

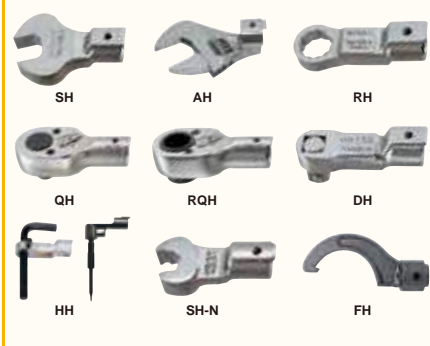

Assembly Pre-Lock Interchangeable Graduation ISO6789:2017

- Interchangeable head version of PQL
- External scale, set by a hex key



PCL100N×15D

Accuracy ±3%

Head Size	S.I. Model	Torque Range [N·m]		Metric Model	Torque Range [kgf·cm]		American Model	Torque Range [lbf·in/lbf·ft]		Overall Length [mm]	Weight [kg]
		Min.-Max.	Grad.		Min.-Max.	Grad.		Min.-Max.	Grad.		
8D	PCL10N×8D	2-10	0.1	100PCL	20-100	1	PCL50L×8D	10-50	0.5	170	0.16
	PCL15N×8D	3-15		150PCL	30-150		PCL100L×8D	20-100	1		
10D	PCL25N×10D	5-25	0.25	225PCL	50-250	2.5	225PCL-A	40-200	2	195	0.22
12D	PCL50N×12D	10-50	0.5	450PCL	100-500	5	450PCL-A	100-400	5	220	0.32
	PCL50N×15D			500PCL			500PCL-A	100-450	5	225	
15D	PCL100N×15D	20-100	1	900PCL	200-1000	10	900PCL-A	15-75	1	295	0.48
	PCL140N×15D	30-140		1400PCL	300-1400		1400PCL-A	30-100	1	355	
19D	PCL200N×19D	40-200	2	1800PCL	400-2000	20	1800PCL-A	30-150	2	435	1.3

Note 1. Overall length does not include interchangeable head.
2. PH type interchangeable head/p.48 is not applicable.
3. Interchangeable heads are optional.

Standard Accessories Hex key for torque adjustment

PCL Optional Accessories

Carrying Case (P.49)

PCLLS

RoHS

- PCL style with Limit Switch output
- Wired Error-Proofing, Pokayoke, system for assembly processes

Refer to page 28.

POKA Patrol, Count Checker
CNA-4mk3

MT70N

Moto Tork/Pre-Lock Adjustable Specialty Torque Wrench

Direction



RoHS



MT70N

Assembly Pre-Lock Interchangeable Graduation

- Converts basic hand tools into torque wrenches
- Ideal for motorcycle maintenance

Accuracy ±5%

S.I. Model	Torque Range [N·m]		Metric Model	Torque Range [kgf·m]		Overall Length [mm]	Weight [kg]
	Min.-Max.	Grad.		Min.-Max.	Grad.		
MT70N	10-70	0.2	MT-7	1.0 -7.0	0.02	238	0.65

Note 1. Ring head wrench shown in the photo is not included.
2. Max. clamp width for interchangeable tool is approx. 21mm.
3. Min. interchangeable hex wrench key size is 5mm.

Standard Accessories 1. Carrying case
2. Hex key wrench for torque adjustment

SCL

European Style Interchangeable Head Type Adjustable Torque Wrench

Direction



RoHS



SCL50N-9×12

Assembly Pre-lock Interchangeable Graduation ISO6789:2017

- DIN interchangeable head connection
- Same function of CL

Accuracy ±3%

S.I. Model	Torque Range [N·m]		Head Size [mm]	Overall Length [mm]	Weight [kg]
	Min.-Max.	Grad.			
SCL25N5-9×12	5-25	0.2	9×12	226	0.3
SCL50N-9×12	10-50	0.5		239	0.37
SCL100N-9×12	20-100	1	313	0.52	
SCL200N-14×18	40-200	2	14×18	464	1.2

Note 1. Overall length does not include interchangeable head.
2. Applicable to European style interchangeable head only. Tohnichi's interchangeable heads are not available for SCL models.
3. SCL25N5-9 × 12N is a yellow/black resin grip.

SCSP

European Style Interchangeable Head Type Preset Torque Wrench

Direction



RoHS



SCSP50N-9×12

Assembly Interchangeable Preset ISO6789:2017

- DIN interchangeable head connection
- Same function of CSP

Accuracy ±3%

Model	Torque Range		Head Size [mm]	Overall Length [mm]	Weight [kg]
	[N·m]	[kgf·cm]			
	Min.-Max.	Min.-Max.			
SCSP25N-9×12	5-25	50-250	9×12	204	0.15
SCSP50N-9×12	10-50	100-500		230	0.3
SCSP100N-9×12	20-100	200-1000	302	0.45	
SCSP200N-14×18	40-200	400-2000	14×18	434	1

Note 1. Overall length does not include interchangeable head.
2. Applicable to European style interchangeable head only. Tohnichi's interchangeable heads are not available for SCL models.

QSP

Ratchet Head Type
Preset Torque Wrench

Direction



Assembly Preset Ratchet Head ISO6789:2003
2017

- No external scale, torque set by a torque wrench tester
- Ideal for mass production application



QSP100N4

Accuracy ±3%

QSP3/QSP-MH Optional Accessories



Adjusting Tool (P.49)

Part #	Applicable Model
931	QSP1.5N4-12N4, QSP25N3/-MH
930	QSP50N3/-MH ~ 280N3/-MH QSP100N4/-MH, 200N4/-MH
314	QSP420N



873

QSP Protective Head Cover (P.49)

Part #	Applicable model
870	QSP1.5N4 - 12N4
871	QSP25N3(-MH)
872	QSP50N3(MH)
873	QSP100N4(-MH)
874	QSP140N3(-MH)
875	QSP200N4
877	QSP280N3
878	QSP420N

Model	Torque Range			Overall Length [mm]	Square Drive [mm]	Weight [kg]
	[N-m] Min.-Max.	[kgf-cm/kgf-m] Min.-Max.	[lbf-in] Min.-Max.			
QSP1.5N4	0.3-1.5	3-15	2.7-13.2	165	6.35	0.16
QSP3N4	0.6-3	6-30	5.3-26.5			
QSP6N4	1-6	10-60	8.9-53.0			
QSP12N4	2-12	20-120	17.7-106	175	9.53	0.25
QSP25N3-1/4	5-25	50-250	45-221	215		
QSP25N3	10-50	100-500	89-442	240	12.7	1.2
QSP50N3				240		
QSP100N4-3/8	20-100	200-1000	177-885	315	19.05	3.1
QSP100N4				315		
QSP140N3				315		
QSP200N4	40-200	400-2000	354-1769	465	19.05	3.1
QSP280N3-1/2	40-280	4-28	354-2477	665		
QSP280N3	60-420	6-42	531-3716	665	19.05	3.1
QSP420N				970		

- Note
1. Adjusting tools are sold separately.
 2. A torque wrench tester is necessary for torque setting. Specify required set torque when you order.
Ex. QSP100N4 x 80N-m
 3. QSP200N4-QSP420N have knurled handles.
 4. QSP1.5N4 and QSP3N4 are issued ISO:6789-2003 certificate when request initial torque setting.

QSPLS

- QSP style with Limit Switch output
- Wired Error-Proofing, Pokayoke, system for assembly processes

Refer to page 28.

QSP-MH

Ratchet Head Type
Preset Torque Wrench
with Metal Handle

Direction



Assembly Preset Ratchet Head ISO6789:2017

- Knurled metal handle version of QSP
- Ideal for oily working conditions



QSP100N4-MH

Accuracy ±3%

Model	Torque Range			Overall Length [mm]	Square Drive [mm]	Weight [kg]
	[N-m] Min.-Max.	[kgf-cm] Min.-Max.	[lbf-in] Min.-Max.			
QSP25N3-MH	5-25	50-250	45-221	215	9.5	0.25
QSP50N3-MH	10-50	100-500	89-442	240		
QSP100N4-MH	20-100	200-1000	177-885	315	12.7	0.65
QSP140N3-MH	30-140	300-1400	266-1238	380		

- Note
1. A torque wrench tester is necessary for torque adjustment. Specify required set torque when you order.
Ex. QSP100N4-MH x 80N-m
 2. Adjusting tools for QSP-MH are sold separately.
 3. Sockets are sold separately. Refer to page 44.

BQSP

Bi-Directional Type
Preset Torque Wrench

Direction



Assembly Preset Ratchet Head Bi-Directional ISO6789:2017

- Click for both CW & CCW applications
- Same function of QSP



BQSP70N

Accuracy ±3%

Model	Torque Range			Overall Length [mm]	Square Drive [mm]	Weight [kg]	Adjusting Tool Part #
	[N-m] Min.-Max.	[kgf-cm/kgf-m] Min.-Max.	[lbf-in] Min.-Max.				
BQSP10N	5-10	50-100	44.3-88.5	213.5	6.35	0.2	931
BQSP20N	10-20	100-200	88.5-177				
BQSP40N	20-40	200-400	177-354	240	9.53	0.4	930
BQSP70N	35-70	350-700	310-619	314			
BQSP120N	60-120	600-1200	531-1061	380	12.7	0.73	930
BQSP220N	110-220	1100-2200	974-1946	462			
BQSP300N	150-300	15-30	1328-2654	665	19.05	2.4	314
BQSP400N	200-420	20-42	1770-3716	970.5			

- Note
1. BQSP10N-300N have resin grips.
 2. BQSP400N has a knurled handle.
 3. Adjusting tool is sold separately.
 4. Sockets are sold separately. Refer to page 44.

BQSP Optional Accessories



Adjusting Tool (P.49)

Part #	Applicable Model
931	BQSP10N-20N
930	BQSP40-300N
314	BQSP400N

CSP

Interchangeable Head Type Preset Torque Wrench

Direction



Assembly Preset Interchangeable ISO6789:2003/2017

- Interchangeable head version of QSP
- No external scale, torque set by a torque wrench tester



CSP100N3x15D Accuracy ±3%

Head Size	Model	Torque Range			Overall Length [mm]	Weight [kg]
		[N·m]	[kgf·cm/kgf·m]	[lbf·in]		
		Min.-Max.	Min.-Max.	Min.-Max.		
8D	CSP1.5N4x8D	0.3-1.5	kgf·cm 3-15	2.7-13.2	130	0.2
	CSP3N4x8D	0.6-3	6-30	5.3-26.5	165	
	CSP6N4x8D	1-6	10-60	8.9-53.0		
10D	CSP12N4x8D	2-12	20-120	17.7-106	195	0.3
	CSP25N3x10D	5-25	50-250	45-221	215	
15D	CSP50N3x12D	10-50	100-500	89-442	220	0.45
	CSP50N3x15D	20-100	200-1000	177-885	290	
	CSP140N3x15D	30-140	300-1400	266-1238	350	
19D	CSP200N3x19D	40-200	400-2000	354-1769	430	1.0
			kgf·m			
22D	CSP280N3x22D	40-280	4-28	354-2477	625	1.4
	CSP420Nx22D	60-420	6-42	531-3716	920	

- Note
1. Overall length does not include interchangeable head.
 2. Adjusting tools are sold separately.
 3. Interchangeable heads are optional.
 4. A torque wrench tester is necessary for torque setting. Specify required set torque when you order.
Ex. CSP100N3x15D x 80N·m
 5. CSP200N3x19D-CSP420Nx22D have knurled handles.
 6. CSP1.5N4x8D and CSP3N4x8D are issued ISO:6789-2003 certificate when request initial torque setting.

CSP Optional Accessories



Adjusting Tool (P.49)

Part #	Applicable Model
931	CSP1.5N4-12N4, 25N3/-MH
930	CSP50N3/-MH ~ 280N3/-MH
314	CSP420N

CSPLS

- CSP style with Limit Switch output
- Wired Error-Proofing, Pokayoke, system for assembly processes

POKA Patrol, Count Checker CNA-4mk3

Refer to page 27.



* Sold separately

CSP-MH

Interchangeable Head Type Preset Torque Wrench with Metal Handle

Direction



CSP100N3x15D-MH

Assembly Interchangeable Preset ISO6789:2017

- Knurled metal handle version of CSP
- Ideal for oily working conditions

Model	Torque Range			Overall Length [mm]	Weight [kg]
	[N·m]	[kgf·cm]	[lbf·in]		
	Min.-Max.	Min.-Max.	Min.-Max.		
CSP25N3x10D-MH	5-25	50-250	45-221	195	0.2
CSP50N3x12D-MH	10-50	100-500	89-442	215	0.3
CSP50N3x15D-MH				220	
CSP100N3x15D-MH	20-100	200-1000	177-885	290	0.45
CSP140N3x15D-MH	30-140	300-1400	266-1238	350	0.55

1. A torque wrench tester is necessary for torque adjustment. Specify required set torque when you order.
Ex. CSP100N3x15D-MH x 80N·m
2. Adjusting tools for CSP-MH are sold separately.
3. Interchangeable heads are optional.

BCSP

Bi-Directional Interchangeable Head Type Preset Torque Wrench

Direction



BCSP70Nx15D

Assembly Preset Interchangeable Bi-Directional ISO6789:2017

- Click for both CW & CCW applications
- Same function of CSP

Head Size	Model	Torque Range			Overall Length [mm]	Effective Length [mm]	Weight [kg]	Adjusting Tool Part #
		[N·m]	[kgf·cm/kgf·m]	[lbf·in]				
		Min.-Max.	Min.-Max.	Min.-Max.				
8D	BCSP10Nx8D	5-10	kgf·cm 50-100	44.3-88.5	189.5	176	0.2	931
10D	BCSP20Nx10D	10-20	100-200	88.5-177	192.5	186		
12D	BCSP40Nx12D	20-40	200-400	177-354	214	208	0.23	
	BCSP70Nx12D	35-70	350-700	310-619	286	280		
15D	BCSP70Nx15D							290
	BCSP120Nx15D	60-120	600-1200	531-1061	348.5	349.5		
19D	BCSP220Nx19D	110-220	1100-2200	974-1946	427	445	1.2	
			kgf·m					
22D	BCSP300Nx22D	150-300	15-30	1328-2654	625	660	2	
	BCSP400Nx22D	200-420	20-42	1770-3716	918	950		

- Note
1. Overall length does not include interchangeable head. Interchangeable heads are optional.
 2. BCSP10N-300N have resin grips.
 3. BCSP400N has a knurled handle.
 4. Adjusting tool is sold separately.

BCSP Optional Accessories

Adjusting Tool (P.49)

Part #	Applicable Model
931	BCSP10N-20N
930	BCSP40N-300N
314	BCSP400N

SP-SP2/-MH RSP2/-MH

Open End/
Ring Head
Type Preset
Torque
Wrench

Assembly

Preset

Open End Spanner

Ring Head

ISO6789:2003
2017

- Various sizes of open end or ring heads fixed on wrench
- Ideal for specific bolt size application

Direction



Model (Body Size x Width)		Torque Range		Head Dimension O.W. x Thickness [mm]	Overall Length [mm]	Weight [kg]			
SP2	SP2-MH	[N-m] Min.-Max.	[kgf-cm] Min.-Max.						
SP2N2x5.5	-	0.4-2	4-20	17 x 5	168	0.15			
SP2N2x7	-			18 x 5	169				
SP2N2x8	-			19 x 5	171				
SP2N2x10	-			21 x 5	173				
SP2N2x12	-			23 x 5	175				
SP2N2x13	-			24 x 5	176				
SP2N2x17	-			27 x 5	180				
SP2N2x19	-			28 x 8	180				
SP8N2x7	-			18 x 5	169				
SP8N2x8	-			19 x 5	171				
SP8N2x9	-	20 x 5	172						
SP8N2x10	-	21 x 5	173						
SP8N2x12	-	1.5-8	15-80	23 x 5	175	0.21			
SP8N2x13	-			24 x 5	176				
SP8N2x19	-			28 x 8	180				
SP8N2x24	-			33 x 8	186				
SP8N2x27	-			36 x 8	189				
SP19N2x10	SP19N2x10-MH			3.5-19	35-190		27 x 6.5	202 (202)	0.37
SP19N2x11	SP19N2x11-MH						203 (204)		
SP19N2x12	SP19N2x12-MH						204 (204)		
SP19N2x13	SP19N2x13-MH						204 (204)		
SP19N2x14	SP19N2x14-MH						204 (205)		
SP19N2x17	SP19N2x17-MH	31 x 8	208 (208)						
SP19N2x19	SP19N2x19-MH	33 x 8	209 (210)						
SP19N2x21	SP19N2x21-MH	35 x 8	211 (212)						
SP19N2-1x10	SP19N2-1x10-MH	24 x 12	205 (205)						
SP19N2-2x10	SP19N2-2x10-MH	24 x 20	204 (204)						
SP19N2-3x10	SP19N2-3x10-MH	24 x 15	205 (205)						
SP38N2x8	SP38N2x8-MH	8-38	80-380	31 x 8	220 (220)	0.48			
SP38N2x9	SP38N2x9-MH			222 (221)					
SP38N2x10	SP38N2x10-MH			222 (222)					
SP38N2x11	SP38N2x11-MH			223 (223)					
SP38N2x12	SP38N2x12-MH			35 x 8	225 (225)				
SP38N2x13	SP38N2x13-MH			226 (226)					
SP38N2x14	SP38N2x14-MH			230 (230)					
SP38N2x16	SP38N2x16-MH			38 x 8	231 (231)				
SP38N2x17	SP38N2x17-MH			41 x 8	234 (234)				
SP38N2x19	SP38N2x19-MH			43 x 8	236 (236)				
SP38N2x22	SP38N2x22-MH	45 x 8	240 (239)						
SP38N2x24	SP38N2x24-MH	13-67	130-670	24 x 12	221 (221)	0.75			
SP38N2x27	SP38N2x27-MH			25 x 20	223 (223)				
SP38N2-1x10	SP38N2-1x10-MH			24 x 15	221 (221)				
SP38N2-2x10	SP38N2-2x10-MH			35 x 10	285 (284)				
SP38N2-3x10	SP38N2-3x10-MH			37 x 10	287 (286)				
SP67N2x14	SP67N2x14-MH			38 x 10	288 (287)				
SP67N2x16	SP67N2x16-MH			39 x 10	289 (287)				
SP67N2x17	SP67N2x17-MH			40 x 10	290 (289)				
SP67N2x18	SP67N2x18-MH			42 x 10	292 (291)				
SP67N2x19	SP67N2x19-MH			43 x 10	293 (292)				
SP67N2x21	SP67N2x21-MH	44 x 11	299 (298)						
SP67N2x22	SP67N2x22-MH	47 x 11	303 (301)						
SP67N2x24	SP67N2x24-MH	24-120	240-1200	49 x 11	304 (303)	0.9			
SP67N2x27	SP67N2x27-MH			50 x 11	305 (304)				
SP67N2x29	SP67N2x29-MH			52 x 11	307 (306)				
SP67N2x30	SP67N2x30-MH			54 x 11	308 (307)				
SP67N2x32	SP67N2x32-MH			42 x 10	360 (359)				
SP67N2x33	SP67N2x33-MH			45 x 10	362 (361)				
SP120N2x14	SP120N2x14-MH			46 x 10	364 (364)				
SP120N2x17	SP120N2x17-MH			47 x 10	365 (364)				
SP120N2x18	SP120N2x18-MH			50 x 10	368 (367)				
SP120N2x19	SP120N2x19-MH			30-160	300-1600		51 x 11	369 (368)	1.5
SP120N2x21	SP120N2x21-MH	53 x 12	370 (369)						
SP120N2x22	SP120N2x22-MH	55 x 14	373 (373)						
SP120N2x23	SP120N2x23-MH	50 x 10	368 (367)						
SP120N2x24	SP120N2x24-MH	52 x 12	369 (369)						
SP120N2x27	SP120N2x27-MH	55 x 12	373 (373)						
SP120N2x30	SP120N2x30-MH	53 x 12	369 (369)						
SP160N2x19	SP160N2x19-MH	55 x 12	373 (373)						
SP160N2x21	SP160N2x21-MH	53 x 12	369 (369)						
SP160N2x22	SP160N2x22-MH	55 x 12	373 (373)						
SP160N2x24	SP160N2x24-MH	70 x 14	386 (386)						
SP160N2x26	SP160N2x26-MH								
SP160N2x27	SP160N2x27-MH								
SP160N2x41	SP160N2x41-MH								

Model (Body Size x Width)		Torque Range		Head Dimension O.W. x Thickness [mm]	Overall Length [mm]	Weight [kg]			
SP/SP2	SP2-MH	[N-m] Min.-Max.	[kgf-cm] Min.-Max.						
SP220N2x19	SP220N2x19-MH	45-220	450-2200	53x13	448 (447)	1.3			
SP220N2x22	SP220N2x22-MH			56x13	451 (450)				
SP220N2x24	SP220N2x24-MH			58x13	453 (452)				
SP220N2x27	SP220N2x27-MH			61x13	456 (455)				
SP220N2x29	SP220N2x29-MH			63x13	458 (458)				
SP220N2x30	SP220N2x30-MH			63x13	460 (460)				
SP220N2x32	SP220N2x32-MH			65x13	464 (464)				
SP220N2x34	SP220N2x34-MH			67x15	463 (463)				
SP220N2x36	SP220N2x36-MH			72x15	468 (467)				
SP310N2x22	SP310N2x22-MH			65-310	650-3100		60x14	647 (646)	1.8
SP310N2x24	SP310N2x24-MH	62x14	648 (647)						
SP310N2x27	SP310N2x27-MH	65x14	651 (650)						
SP310N2x30	SP310N2x30-MH	68x14	654 (653)						
SP310N2x32	SP310N2x32-MH	70x14	655 (654)						
SP310N2x41	SP310N2x41-MH	80x15	670 (670)						
SP310N2x46	SP310N2x46-MH	85x15	671 (671)						
SP420N2x27	-	90-420	900-4200			78x18	840	3.3	
SP420N2x30	-					81x19	995		
SP420N2x32	-					83x19	1000		
SP420N2x34	-			87x19	1005				
SP420N2x35	-			97x19	1005				
SP420N2x36	-			104x19	1010				
SP560N2x30	-			130-560	1300-5600	81x19	995		4.5
SP560N2x32	-					83x19	1000		
SP560N2x36	-					87x19	1005		
SP560N2x46	-					97x19	1005		
SP560N2x55	-	104x19	1010						

Model (Body Size x Width)		Torque Range		Head Dimension O.W. x Thickness [mm]	Overall Length [mm]	Weight [kg]
RSP2	RSP2-MH	[N-m] Min.-Max.	[kgf-cm] Min.-Max.			
RSP8N2x8	-	2-9	20-90	15x6	200	0.15
RSP8N2x10	-			17.5x7	205	
RSP19N2x8	RSP19N2x8-MH	4-14.1	40-141	15x6	220 (220)	0.2
RSP19N2x10	RSP19N2x10-MH			17.5x7	221 (221)	
RSP19N2x13	RSP19N2x13-MH	4-21	40-210	22x7	223 (223)	0.35
RSP38N2x10	RSP38N2x10-MH			9-24.2	90-242	
RSP38N2x12	RSP38N2x12-MH	9-29.5	90-295	20.5x8	247 (247)	0.45
RSP38N2x13	RSP38N2x13-MH			21.5x8	246 (246)	
RSP38N2x14	RSP38N2x14-MH	9-42	90-420	23.5x9	247 (247)	0.8
RSP38N2x16	RSP38N2x16-MH			26x9	248 (248)	
RSP38N2x17	RSP38N2x17-MH	14-59	140-590	27.5x9	312 (311)	0.9
RSP67N2x14	RSP67N2x14-MH			25x10	312 (311)	
RSP67N2x16	RSP67N2x16-MH	14-73	140-730	27x10	313 (312)	1.5
RSP67N2x17	RSP67N2x17-MH			29x12	314 (313)	
RSP67N2x18	RSP67N2x18-MH	24-100	250-1000	29.5x12	315 (314)	0.8
RSP67N2x19	RSP67N2x19-MH			30x12	314 (313)	
RSP120N2x17	RSP120N2x17-MH	24-100	250-1000	29.4x12	393 (393)	0.9
RSP120N2x18	RSP120N2x18-MH			30.6x12	394 (393)	
RSP120N2x19	RSP120N2x19-MH	24-120	250-1270	31.8x13	394 (394)	1.5
RSP120N2x21	RSP120N2x21-MH			34x13	396 (396)	
RSP120N2x22	RSP120N2x22-MH	30-160	320-1700	35x13	396 (396)	2
RSP160N2x19	RSP160N2x19-MH			32.8x13	395 (394)	
RSP160N2x21	RSP160N2x21-MH	45-220	480-2300	34x13	396 (395)	1.5
RSP160N2x22	RSP160N2x22-MH			35x13	396 (396)	
RSP160N2x24	RSP160N2x24-MH	45-220	480-2300	38x15	398 (397)	1.5
RSP220N2x22	RSP220N2x22-MH			38.4x13	480 (479)	
RSP220N2x24	RSP220N2x24-MH	45-220	480-2300	40x13	481 (480)	1.5
RSP220N2x27	RSP220N2x27-MH			45x13	483 (482)	
RSP310N2x24	RSP310N2x24-MH	65-255	680-2550	41.8x15	678 (678)	2
RSP310N2x27	RSP310N2x27-MH			45x15	680 (680)	
RSP310N2x30	RSP310N2x30-MH	65-310	680-3200	50x15	682 (681)	

- Note
1. The value shown in () in the "Overall Length" shows the length of SP2-MH models.
 2. Due to a variety of SP2/RSP2 models, specify required inner width, model name and set torque when you order.
Ex. RSP38N2x10 x 16N-m
 3. Refer to page 49 for thrusting and adjusting tool.
 4. SP2-MH, RSP2-MH models are made to order products.
 5. SP2N2 models are issued ISO:6789-2003 certificate when request torque setting.

SP-SP2-RSP2/-MH Optional Accessories

Thrusting Tool / Adjusting Tool (P.49)

SP2-H Torque Wrench for Piping Work

Direction



RoHS



SP38N2x19H



Assembly Preset Open End Spanner ISO6789:2017

- Made with smaller outside width to work in narrow spaces, including hydraulic piping, where current open-end type is unable to access.
- Aligned with appropriate inner widths commonly used for hydraulic piping applications.

Accuracy ±3%

Model (Body Size x Width)	Torque Range		Minimum Piping Pitch [mm]	Head Dimension (O.W. x Thickness) [mm]	Overall Length [mm]	Weight [kg]	Adjusting Tool Part #
	[N·m]	[kgf·cm]					
SP2-H	Min.-Max.	Min.-Max.					
SP38N2x14H	8-25	80-250	26	26.3x8	220	0.37	930
SP38N2x19H	8-39	80-390	35	33.1x8	224	0.48	
SP67N2x27H	13-67	130-670	46	43.6x11	294	0.75	
SP120N2x32H-MH	24-120	240-1200	54	51.6x14	363	0.75	

- Note
1. Minimum piping pitch is required.
 2. A torque wrench tester is necessary for torque setting. Specify required set torque when you order.
Ex. SP38N2x14H x 25N·m
 3. SP120N2x32H-MH is a knurled handle. Others are resin handles.

Adjusting Tool (P.49) * Sold separately

Part #	Applicable Model
930	SP38N2-H, SP67N2-H, SP120N2x32H-MH

SP2-N/-MH

Direction



RoHS



SP19N2-1x10N



SP19N2-1x10N-MH
*Made to order product



Head Shape "Even"



Head Shape "All down"

Assembly Preset Notched Head ISO6789:2017

- Notch creates speed in tightening process.
- Ideal for brake lines

Accuracy ±3%

Model (Body Size x Width)		Torque Range		Head Dimension		Overall Length [mm]	Weight [kg]	Adjusting Tool Part #
		[N·m]	[kgf·cm]	O.W. x Thickness [mm]	Head Shape			
SP2-N	SP2-N-MH	Min.-Max.	Min.-Max.					
SP19N2-1x10N	SP19N2-1x10N-MH			24x12	Even	203	0.21	931
SP19N2-3x10N	SP19N2-3x10N-MH			24x15				
SP19N2-4x10N	SP19N2-4x10N-MH	3.5-19	35-190	24x10	All down			
SP19N2-5x10N	SP19N2-5x10N-MH			24x15				
SP19N2-9x10N	SP19N2-9x10N-MH			24x10				
SP38N2x14N	SP38N2x14N-MH	8-38	80-380	35x8	Even	224	0.37	930

- Note
1. A torque wrench tester is necessary for torque setting. Specify required set torque when you order.
Ex. SP19N2-1x10N x 15N·m
 2. Adjusting tool for SP19N2-N/-MH is 931 and for SP38N2-N/-MH is 930.
 3. SP2-N-MH models are made to order products.

SPLS2-N/-MH

- SP-N style with Limit Switch output
- Wired Error-Proofing, Pokayoke, system for assembly processes

Accuracy ±3%

Model (Body Size x Width)		Torque Range		Head Dimension		Overall Length [mm]	Weight [kg]	Adjusting Tool Part #
		[N·m]	[kgf·cm]	O.W. x Thickness [mm]	Head Shape			
SPLS2-N	SPLS2-N-MH	Min.-Max.	Min.-Max.					
SPLS19N2-1x10N	SPLS19N2-1x10N-MH			24x12	Even	203	0.36	931
SPLS19N2-3x10N	SPLS19N2-3x10N-MH			24x15				
SPLS19N2-4x10N	SPLS19N2-4x10N-MH	3.5-19	35-190	24x10	All down			
SPLS19N2-5x10N	SPLS19N2-5x10N-MH			24x15				
SPLS19N2-8x10N	SPLS19N2-8x10N-MH			24x12				
SPLS19N2-9x10N	SPLS19N2-9x10N-MH			24x10	Even	224	0.52	930
SPLS38N2x14N	SPLS38N2x14N-MH	8-38	80-380	35x8				

- Note
1. The curl cord length of SPLS19N2-8x10N is about 5m in full extension. Others are extended to about 2m in full extension.
 2. Adjusting tool for SPLS19N2-N/-MH is 931 and for SPLS38N2-N/-MH is 930.
 3. SPLS2-N-MH models are made to order products.

NSP100CNx8

Break-Over Torque Wrench



NSP100CNx8

Assembly Preset Open End Spanner Break-Over ISO6789:2003

- Ideal for SMA connector tightening
- 90 degree of "breaking" upon reaching the set torque to reduce the possibility of over-torque

Accuracy ±5%

Model (Body Size x Width)	Torque Range [cN·m]	Head Dimension [mm]	Overall Length [mm]	Weight [kg]
NSP100CNx8	Min.-Max. 50-100	16x4	128	0.33

- Note
1. A torque wrench tester is necessary for torque setting. Specify required set torque when you order.

■ NSP Optional Accessories



QSPCA Slip Type Torque Wrench

Direction



QSPCA6N



QSPCA30N



QSPCA70N

Assembly Preset Ratchet Head Slip Type ISO6789:2017

- Cam action mechanism generates a 45 degree "slip" action.
- No torque variation by gripping point
- Conforms to the Electrostatic Discharge (ESD) standard

Model	Torque Range			Overall Length [mm]	Sq. Drive [mm]	Weight [kg]	Accuracy [%]
	Min.-Max. [N·m]	Min.-Max. [kgf·cm]	Min.-Max. [lbf·in]				
QSPCA6N	2-6	20-60	20-50	197	6.35	0.33	±6%
QSPCA12N	4-12	40-120	40-100				±4%
QSPCAMS6N	2-6	20-60	20-50				±6%
QSPCAMS12N	4-12	40-120	40-100	267	9.53	0.64	±4%
QSPCA30N	10-30	100-300	90-265				
QSPCA70N	20-70	200-700	180-619	346	9.53	1.24	±4%
QSPCALS30N	10-30	100-300	90-265	267	0.81		
QSPCALS70N	20-70	200-700	180-619	346	1.41		

Note

1. A torque wrench tester is necessary for torque setting. Specify required set torque when you order. Ex. QSPCA6N x 5N·m
2. Adjusting tools for QSPCA are sold separately.
3. Limit Switch specifications are AC30V below 1A, DC30V below 1A.
4. Standard curl cord can be extended to about 2m in full extension.
5. Female connector for LS cable is sold separately. Part# WA5219K.
6. QSPCA70N and QSPCALS70N have knurled handles.

QSPCAMS/ QSPCALS

- QSPCA style with Limit Switch output
- Wired Error-Proofing, Pokayoke, system for assembly processes

RoHS

POKA Patrol, Count Checker CNA-4mk3



QSPCAMS6N



QSPCAMS12N

Refer to page 27.



* Sold separately



QSPCALS30N



QSPCALS70N

Wave form of slip type torque wrench

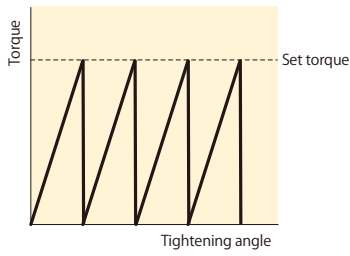

QSPCA Optional Accessories



931

930

Adjusting Tool (P.49)

Part #	Applicable Model
931	QSPCA6N, QSPCAMS6N QSPCA12N, QSPCAMS12N
930	QSPCA30N, QSPCALS30N QSPCA70N, QSPCALS70N QSPCAFH30N, QSPCAFH70N

QSPCAFHP/FHM

- Wireless error-proofing, Pokayoke, system

RoHS

Receiver R-CM

Refer to page 29 for wireless Pokayoke system configuration.

Model
QSPCAFHP6N
QSPCAFHP12N

Model
QSPCAFHLSM30N
QSPCAFHLSM70N



QSPCAFHP12N



QSPCAFHLSM70N

* Sold separately



Note QSPCAFHP transmitter is not provided separately.

YCL2 Two Step Motion Torque Wrench

Direction



YCL90N2x15D

Wave form of two step motion torque.

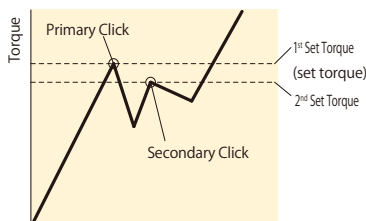

Assembly Adjustable Interchangeable Graduation Two Step Motion ISO6789:2017

- Two step motion prevents over-torque.
- Suitable for assembly of critical parts
- Easy torque setting by graduation
- Interchangeable head

Head Size	S.I. Model	Torque Range [N·m]		Metric Model	Torque Range [kgf·cm]		American Model	Torque Range [lbf-in/lbf-ft]		Max Hand Force [N]	Effective Legth [mm]	Overall Length [mm]	Weight [kg]	
		Min.-Max.	Grad.		Min.-Max.	Grad.		Min.-Max.	Grad.					
					lbf-in	lbf-ft								
10D	YCL10N2x10D	5-10	0.10	100YCL2	50-100	1	YCL100I	50-100	1	46.5	215	245	0.35	
	YCL20N2x10D	10-20	0.20	200YCL2	100-200	2	YCL200I	100-200	2	93				
12D	YCL40N2x12D	20-40	0.25	400YCL2	200-400	2.5	YCL400I	200-400	2.5	145.5	275	309	0.53	
	YCL70N2x12D	35-70	0.50	700YCL2	350-700	5	YCL600I	300-600	5	254.5				
15D	YCL90N2x15D	45-90	0.25	900YCL2	450-900	2.5	YCL750I	400-750	2.5	236.8	380	414	1.05	
	-	-	-	-	-	-	YCL1000I	600-1000	5	-				
19D	YCL140N2x15D	70-140	0.50	1400YCL2	700-1400	5	YCL100F	45-100	0.5	368.4	310	579	607	1.75
	YCL180N2x19D	90-180	-	1800YCL2	900-1800	-	-	-	-	-				
-	-	-	-	-	-	-	YCL150F	80-150	0.5	-	-	-	-	

Accuracy ±3%

CPT-G

PRO TORK/
Digital Torque
Wrench for
Tightening

Direction



RoHS

PRO TORK™



CPT50x12D-G



CPT100x15D-G

How to Order:

[Ex. 1] CPT100x15D-G-SET

* "Set" model version
with standard accessories

[Ex. 2] CPT200x19D-G

* "Torque Wrench Only" version
without standard accessories

CPT-G Optional Accessories



844

Carrying Case for "SET" model only

Part #	Applicable Model Dimension [mm]	Weight [kg]
844	CPT20x10D-G ~ CPT100x15D-G H170 x W500 x D100	1.0
845	CPT200x19D-G, CPT280x22D-G H170 x W740 x D100	1.6



585



Connecting to CPT-G

Connecting Cable

Part #	Applicable Model
585	CPT-G - PC (D-Sub 9 Pin Female)

Data Processing Software

Model
EXCEL RECEIVER

Assembly	Digital	Interchangeable	Signal	Battery	ISO6789:2003
----------	---------	-----------------	--------	---------	--------------

- Highly responsive to the applied torque value with indicator display
- Equipped with bright LED lamp indicating current torque level
- 5 changeable units of measure through keypad set up
- Data memory, torque set registration and output functions

"Torque Wrench Only" Models

Model	Torque Range										Overall Length [mm]	Weight [kg]
	[N-m]		[kgf-cm]		[kgf-m]		[lbf-in]		[bf-ft]			
	Min.-Max.	1 digit	Min.-Max.	1 digit	Min.-Max.	1 digit	Min.-Max.	1 digit	Min.-Max.	1 digit		
CPT20x10D-G	4-20	0.02	40-200	0.2	0.4-2	0.002	36-180	0.2	3-14.5	0.02	280.5	0.63
CPT50x12D-G	10-50	0.05	100-500	0.5	1-5	0.005	100-440	0.5	7.5-36	0.05	282.5	0.65
CPT100x15D-G	20-100	0.1	200-1000	1	2-10	0.01	200-880	1	15-73	0.1	384.5	0.85
CPT200x19D-G	40-200	0.2	400-2000	2	4-20	0.02	360-1700	2	30-150	0.2	475.5	1.37
CPT280x22D-G	56-280		560-2800		5.6-28		500-2400		42-200		591.5	1.76

- Note
1. "Torque Wrench Only" version is provided in basic carton product box and does not include TQH Head, Batteries, Storage Case.
 2. "Overall Length" does not include the length of interchangeable head TQH.
 3. "Weight" does not include the weight of interchangeable head TQH and batteries.
 4. Interchangeable heads are sold separately. Refer to page 45-48.

"Set" Models including Accessories

Model	Standard Accessory			
	Ratchet Head		Battery	Storage Case
	Model	Sq. Drive [mm]		
CPT20x10D-G-SET	TQH10D	9.5	AA Alkaline	Small
CPT50x12D-G-SET	TQH12D			
CPT100x15D-G-SET	TQH15D	12.7	Battery (2 pcs)	Large
CPT200x19D-G-SET	TQH19D			
CPT280x22D-G-SET	TQH22D	19.0		

Note Recommendation: Use 2xAA Ni-MH batteries for longer continuous use.

CPT-G Common Specifications

Accuracy	±3% of indicated value
Tightening Direction	Clockwise/Counter clockwise
Display/Character Height	14 segment LCD 6 digits/7mm
	7 segment LCD 4 digits/3mm
Battery Life Indicator	4 steps
Number of Data Memory	50
Torque Setting Memory	Preset Tightening mode: 10 torque values to register
	Judgment Tightening mode: Up to 10 values of each Upper/Lower/Tightening direction
Basic Function	Auto power off (3 minutes)
	Auto memory/Reset
	Auto zero
	Over torque alarm
Power	AA battery x 2pcs
Continuous Use	40 hours
Operating Condition	0-40 Celsius below 85%RH (no condensation)

Several different tightening modes available to cater to a variety of applications. Quick and accurate tightening while preventing errors.

Modes include:

[Preset Tightening Mode](#), [Judgment Tightening Mode](#), [Peak/Run Modes](#)

* Retightening/loosening torque is performed in the Peak Mode.

Preset Tightening Mode: Allows user to set the target torque with specific % of torque allowable beyond target, then the red LED moves towards the right to indicate the level of the applied torque. When it reaches the target torque range, the blue LED blinks and the buzzer signals tightening completion.

Judgment Tightening Mode: Allows user to set judgment ranges for lower/upper limit in the tightening operation. Upon tightening completion a judgment is made as torque value is stored in the memory.

Display example 1



Preset Tightening Mode
Red LED shows the level of the applied torque

Display example 2



Judgment Tightening Mode
As torque is being applied prior to completion

Display example 3



Judgment Tightening Mode
The case of exceeding target torque range

CTA2-G

Digital Torque and Angle Wrench

Direction



RoHS

CTA100N2x15D-G

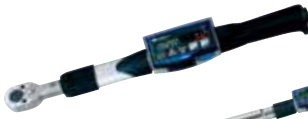

CTA500N2x22D-G



Assembly	Digital	Interchangeable	Signal	Re-Chargeable	ISO6789:2003
----------	---------	-----------------	--------	---------------	--------------

- Snug and angle setting functions
- Buzzer/Light alerts to snug torque and angle completion
- Angle mode activates automatically, once snug torque is achieved.

Accuracy ±1%

Model	Torque Range [N·m]		Torque Range [kgf·m]		Torque Range [lbf·ft]		Angle Measuring Range		Angle Accuracy	Overall Length [mm]	Weight [kg]	Interchangeable Head
	Min.-Max.	1 digit	Min.-Max.	1 digit	Min.-Max.	1 digit	Min.-Max.	1 digit				
CTA50N2x12D-G	(2.5) 10-50	0.05	(0.25) 1-5	0.005	(1.85) 7.5-36.5	0.05			±2°+1digit (Angular velocity is 30°/X-180°/s when the bolt turned to 90°)	282	0.58	QH12D
CTA100N2x15D-G	(5) 20-100	0.1	(0.5) 2-10	0.01	(3.8) 15-75	0.1				384	0.63	QH15D
CTA200N2x19D-G	(10) 40-200	0.2	(1) 4-20	0.02	(7.5) 30-150	0.2	0-999°	1°		475	0.78	QH19D
CTA360N2x22D-G	(18) 72-360	0.4	(1.8) 7-36	0.05	(13) 52-260	0.5				713	1.13	QH22D
CTA500N2x22D-G	(25) 100-500	0.5	(2.5) 10-50	0.05	(18) 72-360	0.5				949	4	
CTA850N2x32D-G	(43) 170-850	1.0	(4.3) 17-85	0.1	(31) 124-620	1			1387	5.14	QH32D	

- Note**
1. The value shown in () shows the lowest snug torque. Accuracy cannot be guaranteed for snug torque set beyond the operative torque range.
 2. Overall length does not include interchangeable head.
 3. PH (Pipe wrench head) type interchangeable head cannot be used with this model.
 4. CTA500N2x22D-G and CTA850N2x32D-G have knurled handles.

Standard Accessories Battery pack/BP-5, QH interchangeable head (P.45), Quick battery charger/BC-3-G (100-240V), cable/584

Torque Wrench for Assembly

CTA2 Optional Accessories

Battery Pack (P.50)

Model
BP-5

Quick Battery Charger (P.50)

Model	Voltage
BC-3-G	100-240V

Printer (P.68)

Model
EPP16M3

Connecting Cable (P.49)

Part #	Applicable Model
575	CTA2-G - PC, EPP16M3 (D-SUB 9 Pin Female)
584	CTA2-G - PC (USB A Type)

- Note**
1. () shows pin shape of the connecting cables.
 2. Contact Tohnichi for other types of connecting cables.

Carrying Case (P.49)

Model	Applicable Model Dimension [mm]	Weight [kg]
846	CTA50N2x12D-G, CTA100N2x15D-G H170 x W500 x D100	1.0
847	CTA200N2x19D-G, CTA360N2x22D-G H170 x W740 x D100	1.6

CTA2-G Features 2 Tightening Modes: Single Spindle and Production Tightening Modes

1. Single Spindle Tightening Mode: For angle method tightening of a single bolt tightening with snug torque, tightening angle and tightening angle upper limit settings.

2. Production Tightening Mode: For angle method tightening of multi spindle, with tightening torque, snug torque, 1st, 2nd and 3rd tightening angle, each upper limited angle, the numbers of spindles are registered.

By using the included software package, various settings can be done through the PC and transferred to the wrench with the final tightening values being sent back to an Excel spreadsheet.



Single spindle tightening mode setting display



Production tightening mode setting display

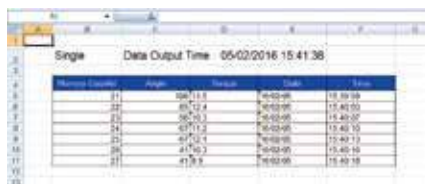

Output data in single spindle tightening mode

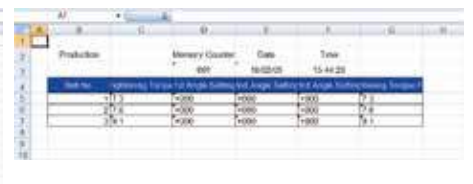

Output data in production tightening mode

CTA2-G Common Specifications

Data Memory	999 data (Tightening torque, 1st angle value, 2nd angle value, 3rd angle value and final torque value)
Measurement Mode	Single spindle/Production mode
Data Output	RS232C compliant
Zero Adjustment	Auto zero (Angle, Torque)
Power	Ni-MH rechargeable battery
Continuous Use	20 hours with fully charged (8 hours by 1 hour recharging)
Recharging Time	3.5 hours
Operating Temperature [°C]	0-40
Other Functions	Snug torque, Tightening torque, Max. tightening torque, 1st, 2nd, 3rd angle, 1st, 2nd, 3rd max. angle, Number of bolts, Auto reset, Judgment, Setting through PC, Battery indicator

DWQL

Analog Torque Wrench with Digital Angle Module

Direction



RoHS



DWQL100N



* M-DW shows 20° from snug torque.

Assembly Adjustable Digital Ratchet Head Graduation ISO6789:2003

- Easily apply snug torque with "click" followed by angle with integrated digital angle display.
- Digital angle starts once snug torque setting is achieved.
- Correct angle is calculated and shown even when ratcheting feature is used.

Accuracy ±3%

S.I. Model	Torque Range [N·m]		Angle Range		Angle Accuracy	Overall Length [mm]	Weight [kg]
	Min.-Max.	Grad.	Min.-Max.	1 digit			
DWQL50N	(5) 10-50	0.5			±2°+1digit (Angular velocity is 30°/s-180°/s when the bolt is turned to 90°.)	260	0.62
DWQL100N	(10) 20-100	1				335	0.86
DWQL140N	(25) 30-140					400	1.00
DWQL200N	(30) 40-200		0-999°	1		490	1.6
DWQL280N	(30) 40-280	2				695	2.2
DWQL420N	(40) 60-420					995	3.6

- Note**
1. The capacity values in the () are minimum setting values for snug torque, but these values are not within guaranteed accuracy range.
 2. A value in the () might not be exact same when purchased M-DW is installed on LS torque wrench.
 3. Certificates of calibration for both torque and angle are included.
 4. Prior to use, confirm final applied torque value do not exceed max torque of the tool.

M-DW

- Convert torque wrench with limit switch to angle torque wrench by installing M-DW.

Digital Angle Module

Model	Description
M-DW	Angle module for torque wrench with limit switch

- Note**
1. M-DW can be installed on torque wrench with limit switch except for the following models: QSPCAL, ALS, ACLS, and MS type torque wrench, Refer to page 28.
 2. Operate within torque range of installed torque wrench.
 3. Certificate of angle calibration is attached.

M-DW Specifications

Range of Angle	0-999°
1digit	1°
Angle Accuracy	±2°+1digit (Angular velocity is 30°/s-180°/s when the bolt is turned to 90°.)
Display	7 segments LED, 3 digits/Character height 10mm
Continuous Operation	60 hours
Operating Condition	0-40°C Below 85%RH (no condensation)
Standard Accessories	Limit switch with connector 1 pc.
	Screw & Washer: 2 pcs. per each
	Operating instruction, AAA battery: 1 pc.
Weight	0.12kg

- Torque wrench with Limit Switch is converted to digital angle torque wrench.

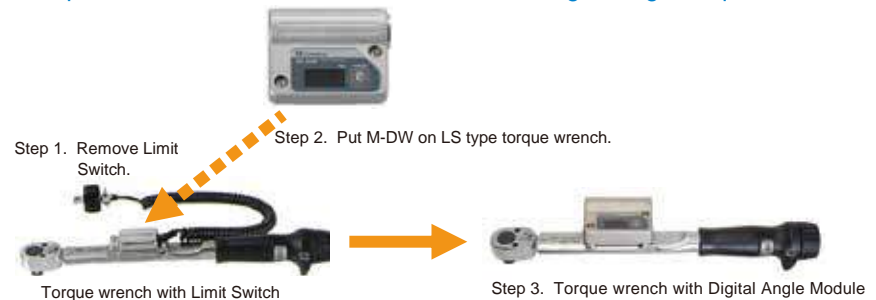

WQL

Analog Torque and Angle Wrench

Direction



RoHS



WQL100N4

Assembly Ratchet Head Graduation Angle Direct Reading ISO6789:2017

- Includes built-in protractor with flexible arm
- Specialized version of QL

Accuracy ±3%

S.I. Model	Torque Range [N·m]		Metric Model	Torque Range [kgf·cm/kgf·m]		Torque Range [lbf·in/lbf·ft]		Sq. Drive [mm]	Overall Length [mm]	Angle Scale		
	Min.-Max.	Grad.		Min.-Max.	Grad.	Min.-Max.	Grad.			Max.	Grad.	
WQL50N	(5) 10-50	0.5	450WQL3	kgf·cm	kgf·m	lbf·in	lbf·in	9.5	260			
				(50) 100-500	0.5	450WQL3-A	(40) 100-400	5				
WQL100N4	(10) 20-100	1	900WQL4	(100) 200-1000	1	900WQL4-A	(7) 15-75	1	12.7	345	360°	2°
WQL200N4	(30) 40-200		1800WQL4	(300) 400-2000	2	1800WQL4-A	(20) 30-150	2		495		
				kgf·m	kgf·m		lbf·ft	lbf·ft				
WQL280N	(30) 40-280	2	2800WQL3	(3) 4-28	0.2	2800WQL3-A	(20) 30-200	2	19.0	695		
WQL420N	(40) 60-420		4200WQL2	(4) 6-42		4200WQL2-A	(30) 60-300			975		

- Note**
1. The capacity value in the () are minimum setting value for snug torque, but this value is not within guaranteed accuracy range.
 2. WQL Models are supplied upon request.

Torque Wrench for Assembly

MPQL/MQL

Direction Marking Torque Wrench



Assembly Pre-Lock Ratchet Head Graduation Quick Drying Ink ISO6789:2017

- Mechanism marks bolt as torque is achieved.
- Requires special socket, marker and ink

S.I. Model	Torque Range [N·m]		Metric Model	Torque Range [kgf·cm/kgf·m]		American Model	Torque Range [lbf·in/lbf·ft]		Overall Length [mm]	Weight [kg]
	Min.-Max.	Grad.		Min.-Max.	Grad.		Min.-Max.	Grad.		
MPQL50N	10-50	0.5	450MPQL	100-500	5	450MPQL-A	100-400 lbf-in	5	246	0.7
MPQL100N4	20-100	1	900MPQL4	200-1000	10	900MPQL4-A	15-75 lbf-ft	1	320	0.95
MPQL140N	30-140		1400MPQL	400-1400		1400MPQL-A	30-100		385	1.1
MPQL200N4	40-200		1800MPQL4	400-2000		1800MPQL4-A	30-150		468	1.8
MQL280N	40-280	2	2800MQL3	4-28 kgf·m	0.2	2800MQL3-A	30-210	2	692	2.6

Note Use Tohnichi's original socket. Standard sockets can not be used.
Standard Accessories Hex key for torque adjustment

MQSP

Marking Torque Wrench

Direction



Assembly Preset Ratchet Head Quick Drying Ink ISO6789:2017

- Mechanism marks bolt as torque is achieved.
- Preset style of MPQL

Model	Torque Range			Overall Length [mm]	Weight [g]
	[N·m]	[kgf·cm]	[lbf·in]		
MQSP50N	10-50	100-500	88.5-442.5	240	0.7
MQSP100N	20-100	200-1000	177-885	315	1.0
MQSP140N	30-140	400-1400	266-1238	380	1.1
MQSP200N	40-200	400-2000	354-1769	465	1.8

Note 1. Use Tohnichi original socket. Standard sockets can not be used.
2. A torque wrench tester is necessary for torque adjustment. Specify required set torque when you order.
3. Adjusting tool #930 is sold separately.
4. MQSP200N has knurled handles.

MPQL/MQL/MQSP Optional Accessories

Marker Head

Model	Part #	Marking size	Color	Applicable Socket Size
MK53RB	1780	5mm	Red, Blue	W17 or more *Need a Marker Guide
MK53WY	1782		White, Yellow	
MK53RB	2780		Red, Blue	
MK53WY	2782	9mm	White, Yellow	W16 or less
MK93RB	2783		Red, Blue	
MK93WY	2785		White, Yellow	

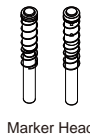

- Note**
- #1780/1782 is for previous sockets, size W16 or less, #1700 to 1704. For the size W17 or more of new Sockets, #2705 to 2717, 2716 and 2717, requires a Marker Guide #2786 additionally.
 - #2783/2785 is for new Sockets only. When use it with an old sockets, size W17 or more, #1705 to 1723, remove Marker Return Spring and a Guide from the Marker Head. Previous 9 mm Marker Head #1783, 1785 can not be used for new Sockets.
 - When newly use 5 mm marking for W17 or more of new Sockets #2705 to 2723, 2716 and 2717, purchase Marker Guide set #2787/2788.

Marker Guide

Model	Part #	Marking size	Content
Marker Guide	2786	-	-
Marker Guide set MK53RB	2787	5mm	1780 and 2786
Marker Guide set MK53WY	2788		1782 and 2786

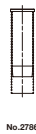

- Note**
- Marker Guide 2786 can be used with Marker Head 1780, 1782 only.
 - 2787 and 2788 are applicable for the sockets over W17, #2705 to 2723, 2716 and 2717.

Refill Ink and Solvent

Model	Part #	Color
Refill Ink R	1770	Red
Refill Ink B	1771	Blue
Refill Ink W	776	White
Refill Ink Y	777	Yellow
Solvent	794	For White and Yellow



- Note**
- Solvent for red and blue inks is not available.
 - Refill Ink and solvent are classified as hazardous material in Aviation law.

Felt Tip

Model	Part #	Color
Felt tip for MK53RB	1775	Red, Blue
Felt tip for MK53WY	775	White, Yellow
Felt tip for MK93RB	1776	Red, Blue
Felt tip for MK93WY	1777	White, Yellow



Note Sold in pack of ten tip

Extension Bar

Specification	Part #	Applicable Model
50mm	1749	MPQL/MQSP50N-200N4
100mm	1748	MPQL/MQSP50N-200N4
50mm	1752	MQL280N



Note Only one Extension Bar can be connected to a socket.

Socket

Model	Part #	Width Across Flat [mm]	Length H [mm]	Outside Width ϕ [mm]	Applicable Torque T-max [N·m]	Applicable Model
Socket 4MH-10	2700	10	100	17.5	25	MQSP/MPQL 50N-200N4
Socket 4MH-12	2701	12		20.5	35	
Socket 4MH-13	2702	13		21.5	40	
Socket 4MH-14	2703	14		22.5	60	
Socket 4MH-16	2704	16		25	70	
Socket 4MH-17	2705	17		28	110	
Socket 4MH-18	2706	18	105	29	120	MQSP/MPQL 50N-200N4
Socket 4MH-19	2707	19		30	170	
Socket 4MH-22	2709	22		30	190	
Socket 4MH-24	2710	24		32.8	200	
Socket 6MH-22	2720	22		32	255	
Socket 6MH-24	2721	24		34.5	255	
Socket 6MH-27	2722	27	110	38.5	255	MQL280N
Socket 6MH-30	2723	30		42	280	

- Note**
- To be applied new Marker Heads #2780 and 2782 to previous W16 or less Sockets #1700 to 1704, remove a spring from the inside of socket and insert it.
 - To use previous W17 or more size of Sockets #1705 to 1723, 2716 and 2717 with 5mm Marker heads #1780/1782, required Marker Guide #2786.

Inch Size Socket

Model	Part #	Width Across Flat		Tmax [lbf·in] (N·m)	Length H [mm]	Outside Width ϕ [mm]	Applicable Model
		[inch]	[mm]				
Socket 4MH-7/16	2712	7/16	11.113	300(35)	100	20	MQSP/MPQL 50N-200N4
Socket 4MH-1/2	2713	1/2	12.7	400(45)		21	
Socket 4MH-9/16	2714	9/16	14.288	700(80)		23	
Socket 4MH-5/8	2715	5/8	15.875	800(90)	105	25.5	MQSP/MPQL 50N-200N4
Socket 4MH-11/16	2716	11/16	17.463	1000(120)		28.5	
Socket 4MH-3/4	2717	3/4	19.05	1500(170)	30		

MPQL/MQSP Torque Adjusting Adapter

Model	Part #	Applicable Model	Applicable Tester
MQSP 3/8-17 Adapter	817	MPQL50N MQSP50N	DOTE50N3-G
MQSP 1/2-17 Adapter	818	MPQL100N4-200N4 MQSP50N-200N	DOTE100N3-G DOTE200N3-G

MQSP Adjusting Tool

Part #	Applicable Model
930	MQSP50N/100N/200N

As of May 2016, sockets and marker head were renewed. Contact to Tohnichi for combination of previous parts and new one.

MCSP

Marking Torque Wrench

Direction

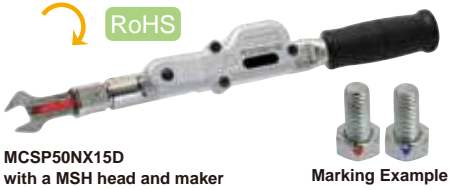

MCSP50NX15D with a MSH head and maker

Marking Example

Assembly Preset Interchangeable ISO6789:2017

- Interchangeable type marking torque wrench.
- Put ink mark on a bolt/nut when torque achieved.

Accuracy ±3%

Head Size	Model	Torque Range			Overall Length [mm]	Weight [kg]
		[N-m] Min.-Max.	[kgf-cm/kgf-m] Min.-Max.	[lbf-in] Min.-Max.		
15D	MCSP50NX15D	10-50	100-500	88.5-442	282	0.65
	MCSP100NX15D	20-100	200-1000	177-885	355	0.9
	MCSP140NX15D	30-140	300-1400	266-1238	418.5	1.0

Note 1. Overall length does not include interchangeable head.
2. Adjusting tools and MSH head, marker pen are sold separately.
3. A torque wrench tester is necessary for torque setting. Specify required set torque when you order.

MPCL

NEW

Marking Torque Wrench

Direction

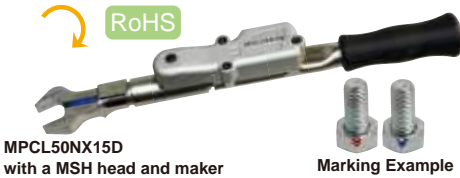

MPCL50NX15D with a MSH head and maker

Marking Example

Assembly Pre-Lock Interchangeable ISO6789:2017

- Pre-lock style of spanner type marking torque wrench.

Accuracy ±3%

Head Size	Model	Torque Range		Standard accessories	Overall Length [mm]	Weight [kg]
		[N-m] Min.-Max.	1 Grad.			
15D	NEW MPLC50NX15D	10-50	0.5	Torque setting hex key	282	0.65
	NEW MPLC100NX15D	20-100	1		355	0.9
	NEW MPCL140NX15D	30-140	1		418.5	1.0

Note 1. Overall length does not include interchangeable head.
2. Adjusting tools and MSH head, marker pen are sold separately.

MCSP/MPCL Optional Accessories

Spanner type Interchangeable Head

Model (Body size x Spanner size)	Tmax. [N-m]	Head Outside Width	Head Thickness	Weight [g]	Applicable Marker End
NEW MSH15Dx10	30	30	7.5	80	1671 Silver
MSH15Dx12		31	8	82	
MSH15Dx13		32		83	
MSH15Dx14		35		84.5	
MSH15Dx16		38		95	
MSH15Dx17	55	39		9	106.5
MSH15Dx18		44	10	108	
MSH15Dx19		46		115	
MSH15Dx21	75	50		11	123
MSH15Dx22		51	12	132.5	
MSH15Dx24		58		132	
MSH15Dx26		60		152.5	
MSH15Dx27	100	51		13	150.5
MSH15Dx30		58	192		
MSH15Dx32		60	194.5		

Note 1. One piece of Maker End and attachment bolt comes with a MSH head.
2. MCSP/MPCL body and MSH head are fixed by the attachment bolt W2 mm.

Marker Pen

Part #	Description
1651	Red maker, 10pcs/pack
1652	Red maker, 100pcs/pack
1653	Blue maker, 10pcs/pack
1654	Blue maker, 100pcs/pack

Note 1. Disposable type maker.
2. 2000 times of stamping by a maker. * It depends on conditions.

Marker End

Part #	Description
1671	Silver
1672	Black
1673	Gold

Adjusting Tool

Part #	Description
930	MCSP50N - 140N

CMQSP

Marking Torque Wrench

Direction

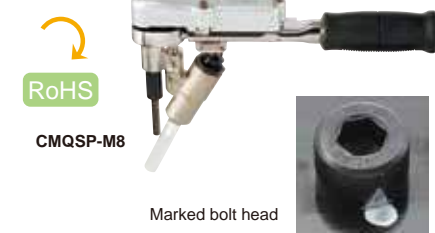

CMQSP-M8

Marked bolt head

Assembly Preset Ratchet Head Quick Drying Ink ISO6789:2017

- Preset style marking torque wrench for hex screws
- Mechanism marks side of bolt and work piece.

Accuracy ±3%

Model	Torque Range			Width Across Flats [mm]	Overall Length [mm]	Weight [kg]
	[N-m] Min.-Max.	[kgf-cm] Min.-Max.	[lbf-in] Min.-Max.			
CMQSP-M6	5-25	50-250	44.3-221.2	5	241	0.85
CMQSP-M8	10-50	100-500	86.5-442.5	6	320	0.85
CMQSP-M10	20-100	200-1000	177-865	8	380	1.13
CMQSP-M12	30-140	300-1400	265.5-1239.1	10	380	1.13

Note A torque wrench tester is necessary for torque setting. Specify required set torque when you order.
Ex. CMQSP-M10 x 50N-m

Standard Accessories 2 x Hex wrench (including 1 spare), Marker head, Marker case, Hex wrench position adjustment tool

CMQSP Optional Accessories

Bit

Part #	Description
724	CMQSP-M6 Bit
725	CMQSP-M8 Bit
726	CMQSP-M10 Bit
727	CMQSP-M12 Bit

Marker Head

Part #	Description
792	Marker Head for CMQSP

Refill Ink and Solvent

Part #	Description
776	White Ink
777	Yellow Ink
794	Solvent

CMQSP Adjusting Adapter

Part #	Description	Applicable Tester
811	CMQSP-M6 Adapter	DOTE20N3-G, 50N3-G, 100N3-G
812	CMQSP-M8 Adapter	
813	CMQSP-M10 Adapter	DOTE200N3-G, 500N3-G
814	CMQSP-M12 Adapter	

CMQSP Adjusting Pole Holder

Part #	Applicable Model	Applicable Tester
815	CMQSP-M6, M8 Pole Holder	DOTE20N3-G, 50N3-G, 100N3-G
816	CMQSP-M10, M12 Pole Holder	DOTE200N3-G, 500N3-G

Note A torque wrench tester, Tohnichi's Adjusting Adapter, and Pole Holder are necessary for CMQSP torque adjustment.

CMQSP Adjusting Tool (P.49)

Part #	Applicable Model
930	CMQSP-M6, M8, M10, M12

CNA-4mk3

RoHS

POKA Patrol/
Count Checker



CNA-4mk3

Assembly Digital Relay Counter Judgment

- Tightening count verification with connecting up to 4 torque wrenches.
- Max. 8 preset counts, timer, alarm by buzzer and lamp function are built in.
- Ideal for manufacturing process management of mixed production line.

Count Display	16 x 32 dot-matrix LEDs
OK/NG Judgment Display	30 x 25 square display lamp (commonly used for OK/NG) OK: Blue lamp turned on NG: Red lamp blinking + Buzzer sounds (4 patterns)
Work No. Selection Display	1-digit 7-segment LED
Count Input	Contact input x 4
Max. Tightening Number of Bolts	99 counts
Max. Number of Works	8 sets
OK/NG Judgment Setting	• Preset judgment, • END input judgment, • Automatic judgment (0 to 300 seconds in steps of 1 second)
Output Function	• OK/NG output (Relay contact output rating: 30 V DC, 1 A, 125 V AC, 0.3 A) • Torque wrench selection signal output (Open collector rating: 100 mA)
Input Function	• SELECT input x 4, • START input, • END input, • RESET input, • WORK SENSOR input
Timer Function Setting	• Double count prevention timer (0 to 10 seconds in steps of 0.1 second) • Automatic reset timer (0 to 60 seconds in steps of 1 second) • Interval warning timer (0 to 99 seconds in steps of 1 second)
Setting Method	Special-purpose application software (USB communication), key operation
Operating Condition	0 ~ 40 °C, Below 85%RH (no condensation)
Power Supply/Electricity Consumption	AC100 ~ 240V ± 10% 50/60Hz, Below 10W
Weight/Dimension	400g, W121 x D175 x H44.9mm

Standard Accessories: Connecting cable (CNA-4mk3 to PC, USB A-B type)

Add the Count Checker to complete your torque verification system, to visualize and track clicks captured from a variety of compatible Tohnichi models.

Compatible Models: • LS/MS Limit Switch Wrenches.

- Wrenches & Receivers Models Series: FH/FHM, FHSLs, FHP, FHD, FD/FDD, BLA, BLE and FMA

CNA-4mk3 Outline

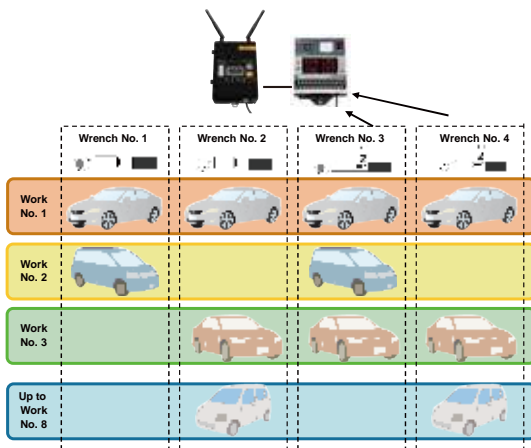

Setting example

Connect 2 LS torque wrenches directly and 2 Wireless torque wrench through R-CM receiver with M-FH module.

Work No.2 is required to tighten 2 different portions, one has hexagon bolts 4pcs and the other has cap screw 3pcs

No.	Setting	WRENCH No.1	WRENCH No.2	WRENCH No.3	WRENCH No.4
2	Tightening count	4	0	3	0



Set the number of bolts (0-99pcs) the work needs for each torque wrench. Set 0 when no torque wrench is needed.

Example of Various Timer Functions

Automatic Judgment Timer (1-300 sec. 1 sec. interval)
Starts after START input or input of first count signal, and judges OK/NG as the timer reaches set time

[Timing chart]

Tightening number 3pcs, Judgment mode JG3, Automatic judgment timer 6sec.

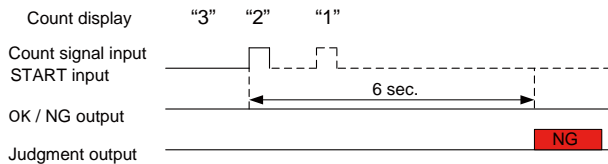

Interval Timer (0-99 sec. 1 sec. interval)

If the operator does not go on to the next bolt within the interval timer (0-99 sec. 1 sec. interval), the alarm goes off to warn the operator.

[Timing chart]

Tightening number 4pcs, Interval timer 5 sec.

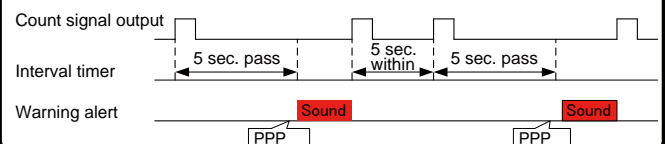

Double count prevention (0.1-10 sec. 0.1 sec. interval)
Prevents counting an accidental double click

[Timing chart]

Tightening number 3pcs, set on 0.5 sec. and operates torque wrench several times within 0.5 sec.

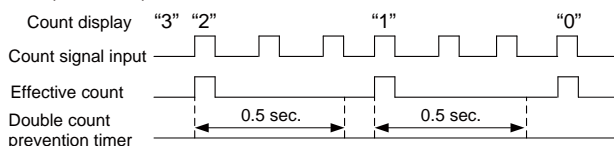

Easy setting with CNA-4mk3 setting software

Setting software gives instruction for each setting parameter.



Torque Wrench with Limit Switch

- Limit switch counts the number of "Clicks".
- Connect to PLC or Count Checker/CNA-4mk3 to build verification system
- Can be upgraded into wireless output system by installing T-FHSL2556



QLLS25N5

QL type with LS

RoHS

S.I. Model	Metric Model
QLMS2N-MH	20QLMS-MH
QLMS5N-MH	50QLMS-MH
QLMS10N-MH	100QLMS-MH
QLMS10N	100QLMS
QLMS15N	150QLMS
QLMS15N-MH	150QLMS-MH
QLLS25N5	225QL5LS
QLLS50N	450QL3LS
QLLS100N4	900QL4LS
QLLS140N	1400QL3LS
QLLS200N4	1800QL4LS
QLLS280N	2800QL3LS
QLLS420N	4200QL2LS

CL type with LS

RoHS

S.I. Model	Metric Model
CLMS2N×8D-MH	20CLMS-MH
CLMS5N×8D-MH	50CLMS-MH
CLMS10N×8D-MH	100CLMS-MH
CLMS10N×8D	100CLMS
CLMS15N×8D	150CLMS
QLMS15N×8D-MH	150CLMS-MH
QLLS25N5×10D	225CL5LS
CLLS50N×12D	450CL3LS
CLLS100N×15D	900CL3LS
CLLS140N×15D	1400CL3LS
CLLS200N×19D	1800CL3LS
CLLS280N×22D	2800CL3LS
CLLS420N×22D	4200CL2LS

SP2/-MH type with LS

RoHS

Model (Body Size × Width)	
SP2MS/SP2LS	SPLS2-MH
SPMS2N×5.5	-
SPMS2N×7	-
SPMS2N×8	-
SPMS2N×10	-
SPMS2N×12	-
SPMS2N×13	-
SPMS2N×17	-
SPMS2N×19	-
SPMS8N×7	-
SPMS8N×8	-
SPMS8N×9	-
SPMS8N×10	-
SPMS8N×12	-
SPMS8N×13	-
SPMS8N×19	-
SPMS8N×24	-
SPMS8N×27	-
SPLS19N2×10	SPLS19N2×10-MH
SPLS19N2×11	SPLS19N2×11-MH
SPLS19N2×12	SPLS19N2×12-MH
SPLS19N2×13	SPLS19N2×13-MH
SPLS19N2×14	SPLS19N2×14-MH
SPLS19N2×17	SPLS19N2×17-MH
SPLS19N2×19	SPLS19N2×19-MH
SPLS19N2X21	SPLS19N2×21-MH
SPLS19N2-1×10	SPLS19N2-1×10-MH
SPLS19N2-2×10	SPLS19N2-2×10-MH
SPLS19N2-3×10	SPLS19N2-3×10-MH
SPLS38N2×8	SPLS38N2×8-MH
SPLS38N2×9	SPLS38N2×9-MH
SPLS38N2×10	SPLS38N2×10-MH
SPLS38N2×11	SPLS38N2×11-MH
SPLS38N2×12	SPLS38N2×12-MH
SPLS38N2×13	SPLS38N2×13-MH
SPLS38N2×14	SPLS38N2×14-MH
SPLS38N2×16	SPLS38N2×16-MH
SPLS38N2×17	SPLS38N2×17-MH
SPLS38N2×19	SPLS38N2×19-MH
SPLS38N2×22	SPLS38N2×22-MH
SPLS38N2×24	SPLS38N2×24-MH
SPLS38N2×27	SPLS38N2×27-MH
SPLS38N2-1×10	SPLS38N2-1×10-MH
SPLS38N2-2×10	SPLS38N2-2×10-MH

- Note
1. Refer to base model series for torque ranges and wrench specs.
 2. Female connector for LS cable is sold separately, Part# WA5219K.
 3. Standard curl cord can be extended to about 2m in full extension.



QLLS100N4

QSP type with LS

RoHS

Model
QSPMS12N4
QSPLS25N3
QSPLS50N3
QSPLS100N4
QSPLS140N3
QSPLS200N4
QSPLS280N3
QSPLS420N

CSP type with LS

RoHS

Model
CSPMS12N4×8D
CSPLS25N3×10D
CSPLS50N3×12D
CSPLS50N3×15D
CSPLS100N3×15D
CSPLS140N3×15D
CSPLS200N3×19D
CSPLS280N3×22D
CSPLS420N×22D

QRSP type with LS

RoHS

Model
QRSPLS38N×17
QRSPLS38N×19
QRSPLS38N×21
QRSPLS38N×24

SP2/-MH type with LS

RoHS

Model (Body Size × Width)	
SP2LS	SP2LS-MH
SPLS38N2-3×10	SPLS38N2-3×10-MH
SPLS67N2×14	SPLS67N2×14-MH
SPLS67N2×16	SPLS67N2×16-MH
SPLS67N2×17	SPLS67N2×17-MH
SPLS67N2×18	SPLS67N2×18-MH
SPLS67N2×19	SPLS67N2×19-MH
SPLS67N2×21	SPLS67N2×21-MH
SPLS67N2×22	SPLS67N2×22-MH
SPLS67N2×24	SPLS67N2×24-MH
SPLS67N2×27	SPLS67N2×27-MH
SPLS67N2×29	SPLS67N2×29-MH
SPLS67N2×30	SPLS67N2×30-MH
SPLS67N2×32	SPLS67N2×32-MH
SPLS67N2×33.3	SPLS67N2×33.3-MH
SPLS120N2×14	SPLS120N2×14-MH
SPLS120N2×17	SPLS120N2×17-MH
SPLS120N2×18	SPLS120N2×18-MH
SPLS120N2×19	SPLS120N2×19-MH
SPLS120N2×21	SPLS120N2×21-MH
SPLS120N2×22	SPLS120N2×22-MH
SPLS120N2×23	SPLS120N2×23-MH
SPLS120N2×24	SPLS120N2×24-MH
SPLS160N2×19	SPLS160N2×19-MH
SPLS160N2×21	SPLS160N2×21-MH
SPLS160N2×22	SPLS160N2×22-MH
SPLS160N2×24	SPLS160N2×24-MH
SPLS160N2×26	SPLS160N2×26-MH
SPLS160N2×27	SPLS160N2×27-MH
SPLS220N2×19	SPLS220N2×19-MH
SPLS220N2×22	SPLS220N2×22-MH
SPLS220N2×24	SPLS220N2×24-MH
SPLS220N2×27	SPLS220N2×27-MH
SPLS220N2×29	SPLS220N2×29-MH
SPLS220N2×30	SPLS220N2×30-MH
SPLS220N2×32	SPLS220N2×32-MH
SPLS220N2×34	SPLS220N2×34-MH
SPLS220N2×36	SPLS220N2×36-MH
SPLS310N2×22	SPLS310N2×22-MH
SPLS310N2×24	SPLS310N2×24-MH
SPLS310N2×27	SPLS310N2×27-MH
SPLS310N2×30	SPLS310N2×30-MH
SPLS310N2×32	SPLS310N2×32-MH
SPLS310N2×41	SPLS310N2×41-MH
SPLS310N2×46	SPLS310N2×46-MH

4. The curl cord length of SPLS19N2-8×10N is about 5m in full extension.
5. SPLS-MH, RSPLS-MH models are made to order products.
6. SPMS2 models come with ISO6789:2003 cert when request torque setting.



SPLS38N2×17-MH

PQL type with LS

RoHS

S.I. Model	Metric Model
PQLLS25N	225PQLLS
PQLLS50N	450PQLLS
PQLLS100N4	900PQL4LS
PQLLS140N	1400PQLLS
PQLLS200N4	1800PQL4LS
PQLLS280N	2800PQLLS
PQLLS420N	4200PQLLS

PCL type with LS

RoHS

S.I. Model	Metric Model
PCLLS25N×10D	225PCLLS
PCLLS50N×10D	450PCLLS
PCLLS50N×12D	500PCLLS
PCLLS100N×15D	900PCLLS
PCLLS140N×15D	1400PCLLS
PCLLS200N×19D	1800PCLLS

TiQL type with LS

RoHS

Model	Metric Model
TiQLLS180N	1800TiQLLS
TiQLLS180N	1800TiQLLS
TiEQLLS360N	3600TiEQLLS

QSPCA type with LS

RoHS

Model
QSPCAMS6N
QSPCAMS12N
QSPCAL30N
QSPCAL70N

RSP2/-MH type with LS

RoHS

Model (Body Size × Width)	
RSP2MS/RSP2LS	RSP2LS-MH
RSPMS8N2×8	-
RSPMS8N2×10	-
RSPMS19N2×8	RSPLS19N2×8-MH
RSPMS19N2×10	RSPLS19N2×10-MH
RSPMS19N2×13	RSPLS19N2×13-MH
RSPMS38N2×10	RSPLS38N2×10-MH
RSPMS38N2×12	RSPLS38N2×12-MH
RSPMS38N2×13	RSPLS38N2×13-MH
RSPMS38N2×14	RSPLS38N2×14-MH
RSPMS38N2×16	RSPLS38N2×16-MH
RSPMS38N2×17	RSPLS38N2×17-MH
RSPMS67N2×14	RSPLS67N2×14-MH
RSPMS67N2×16	RSPLS67N2×16-MH
RSPMS67N2×17	RSPLS67N2×17-MH
RSPMS67N2×18	RSPLS67N2×18-MH
RSPMS67N2×19	RSPLS67N2×19-MH
RSPMS120N2×17	RSPLS120N2×17-MH
RSPMS120N2×19	RSPLS120N2×19-MH
RSPMS120N2×22	RSPLS120N2×22-MH
RSPMS160N2×19	RSPLS160N2×19-MH
RSPMS160N2×22	RSPLS160N2×22-MH
RSPMS160N2×24	RSPLS160N2×24-MH
RSPMS220N2×22	RSPLS220N2×22-MH
RSPMS220N2×24	RSPLS220N2×24-MH
RSPMS220N2×27	RSPLS220N2×27-MH
RSPMS310N2×24	RSPLS310N2×24-MH
RSPMS310N2×27	RSPLS310N2×27-MH
RSPMS310N2×30	RSPLS310N2×30-MH

SP2-N/-MH type with LS

RoHS

Model (Body Size × Width)	
SP2LS-N	RSP2LS-N-MH
SPLS19N2-1×10N	SPLS19N2-1×10N-MH
SPLS19N2-3×10N	SPLS19N2-3×10N-MH
SPLS19N2-4×10N	SPLS19N2-4×10N-MH
SPLS19N2-5×10N	SPLS19N2-5×10N-MH
SPLS19N2-8×10N	SPLS19N2-8×10N-MH
SPLS19N2-9×10N	SPLS19N2-9×10N-MH
SPLS38N2×14N	SPLS38N2×14N-MH

Limit switch specifications

- AC30V Below 1A
DC30V Below 1A

R-CM

Modular Conversion Receiver

RoHS



R-CM



R-CM with M-FH radio module



Mounting position of Radio Module

- Modular radio receiver for wireless torque wrench and driver
- Interchangeable modules allow for easy upgrades from basic radio signal to torque data transfer system
- Accepts 4 different interchangeable radio modules with ability to accept the next generation modules with easy exchange on the R-CM unit.

Specifications

Model	Receiver	Available Radio Module			
	R-CM	M-FH	M-FD	M-BLA	M-BLE
Frequency	Depend on the module	2.402GHz-2.479GHz		902.875MHz	868.3MHz
Communication		Spread spectrum (FHSS)		-	-
Modulation		GFSK		FSK	ASK
Group channel		256 (000-255)		-	-
ID		3-digits (000-999), 7-digits alphanumeric		8-digits fixed, not selectable	
In/Output	Relayx4, RS232C	-	-	-	-
Input	LS-IN, Reset	-	-	-	-
Power supply	DC24V	-	-	-	-
Antenna	Depend on the module	Diversity antenna		Dipole antenna	
Distance		M-FH mode: 10 - 30m R-FH mode: 10 - 20m	10 - 20m	10 - 20m	
Temperature in use	0 - 50 °C				
Weight (kg)	0.24	0.047	0.036	0.36	0.035
Other function	Time stamp, Battery alert, Remote setting, Quick pairing, Count checker (OUT1, OUT2)	M-FH mode, R-FH mode:	-	-	-

Note

1. Communication distance varies depending on surrounding radio environment.
2. M-FH mode: Advanced function mode, available Time stamp, Battery alert, long-distance communication mode.
R-FH mode: Compatible mode with previous FH256MC series
3. M-FH mode is available for the newly updated T-FH/T-FHM transmitter which has a white antenna cover.
The previous transmitter, black antenna cover type is available at R-FH mode only and cannot be converted.
4. M-FD, M-BLA/BLE are not support Remote Setting function.
5. Count checker function is not available for M-FD.
6. Multiple wrenches can connect to one receiver as long as they do not signal at the exact same time.
7. An Ethernet terminal can be attached as an option.
8. Contact Tohnichi for status of wireless certification acquisition for each country.

Standard Accessory Part No. 1070

R-CM New Functions

Advanced Longer Distance Radio Wave

R-CM with M-FH module at M-FH mode, the wraparound radio wave avoids obstructions between receiver and transmitter.

* For T-FH/T-FHM/FHW at M-FH mode

Battery Alert

R-CM receives residual battery life signal from the transmitter and alerts when the voltage drops.

* For T-FH/T-FHM/FHW at M-FH mode

Quick Pairing

Easy pairing with transmitters when the tools require replacement

* For previous T-FH256MC and T-FH/T-FHM/FHW

Remote Setting

Group, ID and Judgment code are changed remotely. Convenient when receiver is located out of reach.

* For previous T-FH256MC and T-FH/T-FHM/FHW

Count Checker Function

Available count checker function (1-99 count) for the wrench set in Output 1.

* For M-FH, M-BLA and M-BLE

R-CM Optional Accessories



M-FH

M-FD

M-BLA

M-BLE



IO-CM

BZ-CM

SB-FH2



Part No. 1070

BA-8R

Radio Module

Interchangeable Type Radio Modules for R-CM

RoHS

Model	Specification	Available Transmitter
M-FH	2.402GHz-2.479GHz FHSS radio signal	R(N)TDFH/FHP/FHSL256/T-FH256MC(-LS), T-FH, T-FHM, FHW
M-FD	2.402GHz-2.479GHz FHSS data transfer	T-FD
M-BLA	902.875MHz solar powered radio signal	T-BLA
M-BLE	868.3MHz solar powered radio signal	T-BLE

Standard Accessory Antenna

Optional Extension Box

Extend relay output and loud buzzer with big lamp of R-CM

RoHS

Model	Applicable Module	Specification
IO-CM	M-FH, M-BLA, M-BLE	Add additional 4 relay output
BZ-CM	M-FH, M-FD, M-BLA, M-BLE	Extend loud-buzzer and large lamp

Note

The power is supplied from R-CM.

Setting Box

Manage 4 tightening signals from receiver and output to external device

RoHS

Model	Applicable Module	Specification
SB-FH2	M-FH, M-FD	Input RS232C, Power DC9V battery x 1

AC Adapter

AC adapter for R-CM

Model	Applicable Model	Description
BA-8R	R-CM	AC100V-240V, cable length 2m

Connecting Cable

For setting and RS232C data output

Part No.	Description
387	D-sub 9 Pin female

DIN Rail

280mm DIN rail to fixing R-CM, IO-CM and BZ-CM

Part No.	Description
1070	280mm

FH Series

Radio Frequency
Torque Wrench System



QLFHM100N4



SPFHM19N2X14



CSPFHP3N4X8D *



QSPFHP6N4



CSPFHP12N4X8D
with QH head



QSPCAFHP12N



T-FH / T-FHM



T-FHLS256



R-CM



IO-CM



BZ-CM



R-CM, IO-CM and BZ-CM
with fixing on
standard accessory
DIN rail Part No.1070.



M-FH



SB-FH2



FH-MHD



FH-COD

- Wireless error-proofing, Pokayoke, system by 2.4GHz FHSS ISM band
- Wrench ID transfer feature establishes bolt tightening traceability
- R-CM+M-FH module features diversity antenna for long-range communication
- Easily change frequency with wireless setting box, SB-FH2

Torque wrench with FH256MC transmitter popular model series.

QLFH *Adjustable type
S.I. Model
QLFHM25N5
QLFHM50N
QLFHM100N4
QLFHM140N
QLFHM200N4
QLFHM280N
QLFHM420N

QLFH *Adjustable type
Metric Model
225QL5FHM
450QL3FHM
900QL4FHM
1400QL3FHM
1800QL4FHM
2800QL3FHM
4200QL2FHM

QSPFH * Preset type
Model
QSPFHM25N3
QSPFHM50N3
QSPFHM100N4
QSPFHM140N3
QSPFHM200N4
QSPFHM280N3
QSPFHM420N

CSPFH * Preset type
Model
CSPFHM25N3X10D
CSPFHM50N3X12D
CSPFHM50N3X15D
CSPFHM00N4X15D
CSPFHM140N3X15D
CSPFHM200N3X19D
CSPFHM280N3X22D
CSPFHM420N3X22D

- Note**
1. Refer to base model series for torque ranges and wrench specs.
 2. Can be mounted on any other torque wrenches, contact to distributor or Tohnichi
 3. The wrench's model with "FHM" is set at M-FH mode in initially, it is available advance long-range mode, battery alert with using R-CM and M-FH module. The wrenches model "FH", (e.g. QLFH100N4), is set the transmitter at R-FH mode in default for corresponding to previous R-FH256 receiver.

FHP transmitter for small size torque wrenches

- Applicable to small torque wrenches with a range from 0.4 to 15N·m

QLFHP
S.I. Model
QLFHP10N
QLFHP15N

CLFHP
Model
CLFHP10NX8D
CLFHP15NX8D

QSPFHP
Model
QSPFHP1.5N4 *
QSPFHP3N4 *
QSPFHP6N4
QSPFHP12N4

SP2FHP
Model
SPFHP2N2X5.5
SPFHP2N2X7
SPFHP2N2X8
SPFHP2N2X10
SPFHP2N2X12
SPFHP2N2X13
SPFHP2N2X17
SPFHP2N2X19
SPFHP8N2X7
SPFHP8N2X8
SPFHP8N2X9
SPFHP8N2X10
SPFHP8N2X12
SPFHP8N2X13
SPFHP8N2X19
SPFHP8N2X24
SPFHP8N2X27

RSP2FHP
Model
RSPFHP8N2X8
RSPFHP8N2X10

- Note**
1. Refer to base model series for torque ranges and wrench specs.
 2. FHP transmitter is using the same T-FHLS transmitter module as T-FHLS256.
 3. FHP transmitter is provided in combination with a torque wrench.

* Position of FHP transmitter is on the back surface at rightangles

QLFHP-MH
S.I. Model
QLFHP2N-MH *
QLFHP5N-MH *
QLFHP10N-MH
QLFHP15N-MH

CLFHP-MH
Model
CLFHP2NX8D-MH *
CLFHP5NX8D-MH *
CLFHP10NX8D-MH
CLFHP15NX8D-MH
CLFHP15NX8D-MH

CSPFHP
Model
CSPFHP1.5N4X8D *
CSPFHP3N4X8D *
CSPFHP6N4X8D
CSPFHP12N4X8D

PQLFHP
S.I. Model
PQLFHP5N *
PQLFHP10N
PQLFHP15N

PCLFHP
Model
PCLFHP5NX8D *
PCLFHP10NX8D
PCLFHP15NX8D

QSPCAFHP
Model
QSPCAFHP6N
QSPCAFHP12N

Transmitter Module

Model	Description	Dimension [mm]	Selectable Mode
T-FHM	AAA battery x 1, 650,000 times of use	W36 x D80 x H18	M-FH/R-FH (Default: M-FH)
T-FH	AAA battery x 1, 650,000 times of use	W36 x D80 x H18	M-FH/R-FH (Default: R-FH)
T-FHLS256	CR2032 battery x 1, 300,000 times of use	W32.4 x D56 x H22.3	N/A (R-FH mode only)

- Note**
1. Transmission distance 10-20 m at R-FH mode and 10-30 m at M-FH mode.
 2. T-FH and T-FHM are changeable the operation mode by SB-FH2 setting box.
 3. T-FHLS256 is a wireless transmitter module to be installed on LS type torque wrenches.

Modular Conversion Receiver

Interchangeable radio module type receiver

Model	Specification	Standard Accessories
R-CM	Output: No-Voltage contact output x 4, RS232C, Input: LS-IN, Reset, Power: DC24V	Part. No. 1070

Note Radio module is not included, it is optional.

Radio Module

Interchangeable type radio module for R-CM

Model	Specification	Standard Accessories
M-FH	2.402GHz-2.479GHz Spred spectrum (FHSS)	Diversity antenna

Note Required to set and change frequency of receiver and transmitter.

Optional Extension Box

Extend relay output and loud buzzer with large lamp of R-CM

Model	Applicable Model	Specification
IO-CM	R-CM with M-FH, R-CM with M-BLA/BLE	Add additional 4 relay output
BZ-CM	R-CM with M-FH/M-FD/M-BLA/BLE	Extend loud-buzzer with large lamp

Note The power is supplied from R-CM.

Setting Box

Manage 4 tightening signals from receiver and output to external device

Model	Applicable Model	Specification
SB-FH2	R-CM with M-FH or M-FD, T-FH/T-FHM	Input RS232C, Power DC9V battery x 1

Antenna Extension Cable

Extends antenna from R-FH256 receiver to improve communication conditions

Model	Description	Applicable Model	Specification
FH-MHD	Magnet antenna holder	R-CM with M-FH or M-FD	Cable Length: 1.5m
FH-COD	Antenna extension cable		Cable Length: 9.5m

Protective Cover

Install on transmitter (T-FH256MC and T-FHLS256) to protect from physical damage

Model	Applicable Model	Specification
FHM-PCV	T-FH / T-FHM	NBR
FHLS-PCV	T-FHLS256, T-FMA	Material: Silicon Resin

Contact Tohnichi or distributor for conditions of wireless certification acquisition for each country.

FHW

Radio Frequency Torque Wrench with Double Tightening Detection

Direction



RoHS



- Radio frequency torque wrench system with double tightening detection
- Mechanically detect double tightening and prevent double counting
- R-CM+M-FH module features diversity antenna for long-range communication
- Compatible to both previous R-FH256 receiver and R-CM with M-FH module

Head Size	Model	Torque Range			Overall Length [mm]	Weight [kg]
		[N·m]	[kgf·cm/kgf·m]	[lbf·in]		
		Min.-Max.	Min.-Max.	Min.-Max.		
10D	CSPFW25N3x10D	5-25	50-250	44.3-221.2	193	0.32
12D	CSPFW50N3x12D	10-50	100-500	88.5-442.5	214	0.46
	CSPFW50N3x15D				217	
15D	CSPFW100N3x15D	20-100	200-1000	177-885	290	0.65
	CSPFW140N3x15D	30-140	300-1400	265.5-1239.1	349	0.75
19D	CSPFW200N3x19D	60-200	400-2000	354-1770.1	429	1.24
22D	CSPFW280N3x22D	kgf·m			627	1.66
		100-280	4-28	354-2478.2		

Accuracy ±3%

Note 1. Consult to Tohnichi or distributor for any other types of torque wrench.
 2. FHW transmitter has both R-FH, previous FH256MC mode and M-FH, advanced mode for R-CM+M-FH.
 3. Set at R-FH mode as factory default, selecting modes, R-FH or M-FH can be done by SB-FH2.

Two Steps Click of double tightening detection

FHW mechanically detects rotated angle from A point to B using limit switches and a gyro sensor inside the transmitter, it can detect double tightening without error.

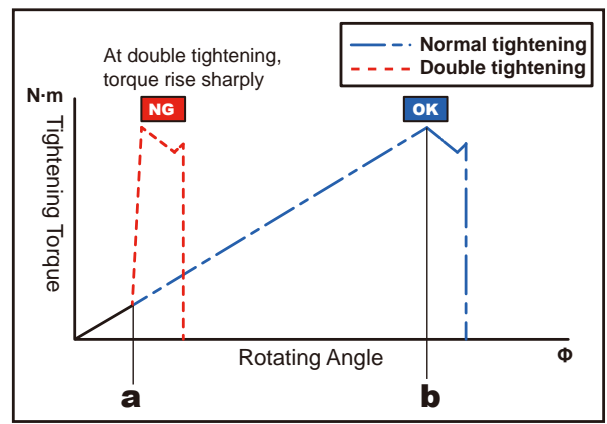

- 1st click: Light click feeling, it starts angle detection --- a
- 2nd click: Strong click when reaches set torque --- b



The transmitter can send 3-digits of double tightening detection signal to the R-CM. By receiving the signal via RS232C, the external device can monitor whether double tightening has occurred. Setting software is available for angle setting and double tightening signal ON/OFF. Note: Angle setting can be conducted by the FHW itself and the tightening application.

Advanced Wireless Pokayoke Communication

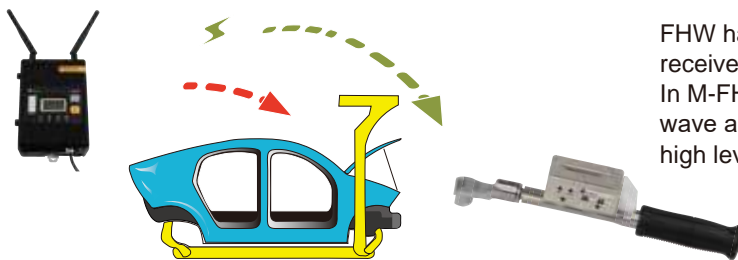

FHW has advanced wireless communication with R-CM receiver and the M-FH module. In M-FH mode, the diversity antenna and wraparound radio wave are effective in avoiding obstructions and achieves a high level of reliable communications.

FHW Optional Accessories



R-CM

M-FH

Modular Conversion Receiver RoHS

Model	Specification
R-CM	Output: Relay x 4, RS232C, Input: LS-IN, Reset

Note Power source: DC24V

Connecting Cable RoHS

Part No.	Applicable Model	Specification
387	SB-FH2, R-CM - PC	RS232C straight

Protective Cover RoHS

Model	Applicable Model	Specification
FHW-PCV	FHW	Material: NBR

AC Adaptor for R-CM RoHS

Model	Description	Cable length
BA-8R	AC100V-240V	approx. 2m

Radio Module RoHS

Model	Specification	Standard Accessory
M-FH	2.4GHz FHSS	Material: Silicon Resin

Standard Accessory Diversity antenna

Setting Box RoHS

Model	Available Setting Items	Dimension [mm]
SB-FH2	Group channel, Judgment code, 3-digit/7-digit ID, Communication settings	W160 x D120 x H35

Note 1. Provide PC setting software
 2. RS232C straight cable needs optionally to use setting software.

Standard Accessory Dipole antenna

BL Battery Less Wireless Torque Wrench

Direction



CSPBLA25N3x10D with SH-N head
CSPBLE25N3x10D with SH-N head



T-BLA/T-BLE



T-BLA



T-BLE



R-CM



IO-CM



BZ-CM



M-BLA



M-BLE



BL-PCV



BA-8R

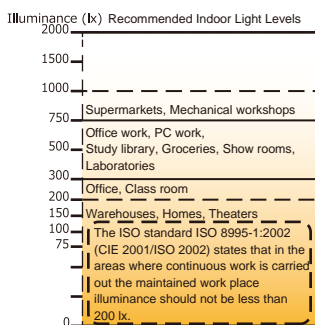

- Solar powered radio frequency torque wrench system
- Eliminates the need for battery replacements
- Chargeable under level of illuminance 200lx.
- Great for the environment
- Available on a wide variety of click type torque wrenches.

QSPBLA *QSP with T-BLA

Model
QSPBLA25N3
QSPBLA50N3
QSPBLA100N4
QSPBLA140N3
QSPBLA200N4
QSPBLA280N3
QSPBLA420N

CSPBLA *CSP with T-BLA

Model
CSPBLA25N3x10D
CSPBLA50N3x12D
CSPBLA50N3x15D
CSPBLA100N3x15D
CSPBLA140N3x15D
CSPBLA200N3x19D
CSPBLA280N3x22D
CSPBLA420Nx22D

QSPBLE *QL with T-BLE

Model
QSPBLE25N3
QSPBLE50N3
QSPBLE100N4
QSPBLE140N3
QSPBLE200N4
QSPBLE280N3
QSPBLE420N

CSPBLE *CSP with T-BLE

Model
CSPBLE25N3x10D
CSPBLE50N3x12D
CSPBLE50N3x15D
CSPBLE100N3x15D
CSPBLE140N3x15D
CSPBLE200N3x19D
CSPBLE280N3x22D
CSPBLE420Nx22D

Note Available in USA and Canada only

Note Available in EU and China only

SPBLA *SP with T-BLA

Model
SPBLA38N2x14
SPBLA38N2x27

Note Available in USA and Canada only

SPBLE *SP with T-BLE

Model
SPBLE38N2x14
SPBLE38N2x27

Note Available in EU and China only

Transmitter module

Model	Description	Dimension [mm]
T-BLA	BLA Transmitter for USA and Canada	W34.4 x D73 x H23.2mm
T-BLE	BLE Transmitter for EU and China	

- Note
1. T-BLA/BLE can be installed on LS type torque wrenches.
 2. LED on the side of transmitter to check communication status
 3. For repair or conversion.

Modular Conversion Receiver

Model	Description	Standard Accessories
R-CM	Output: No-Voltage contact output x 4, RS232C, Input: LS-IN, Reset, Power: DC24V	Part. No. 1070

- Note
1. Simultaneous reception from multiple torque wrenches cannot be done.
 2. It transmits relay signal up to 4 torque wrenches.
 3. Required to capture signal from BLA/BLE wrenches.

Interchangeable Radio Module

Model	Available Area	Standard Accessory
M-BLA	T-BLA for US and Canada	Dipole Antenna
M-BLE	T-BLE for EU and China	

Optional Extension Box

Model	Specification
IO-CM	Add additional 4 relay output
BZ-CM	Extend loud-buzzer and large lamp

Protective Cover

Model	Applicable model	Material
BL-PCV	T-BLA, T-BLE	NBR

AC Adaptor for R-CM

Model	Description	Cable length
BA-8R	AC100V-240V	approx. 2m

Specifications of BLA/BLE

Approved Market	USA and Canada		EU and China	
	Transmitter	Receiver	Transmitter	Receiver
Model	T-BLA	R-CM with M-BLA	T-BLE	R-CM with M-BLE
Frequency	902.875MHz		868.3MHz	
Modulation Method	FSK		ASK	
Modulation Speed	125kbps			
ID	8 digits ID /Non-modifiable			
Input/Output	-	Output: Relay x4, RS232C Input: Reset-in, LS-in	-	Output: Relay x4, RS232C Input: Reset-in, LS-in
Power Supply	Solar cell	DC24V/18 ~ 36V Power consumption: Less than 5W	Solar cell	DC24V/18 ~ 36V Power consumption: Less than 5W
Antenna	Whip antenna	Dipole antenna	Helix antenna	Dipole antenna
Operating Temperature [°C]	0 ~ 40			
Communication Distance	10 - 20m			
Acquisition of License	FCC/USA, IC/Canada		CE/EU, CMIIT/China	

FMA *For United States and Canada Only

Radio Frequency Torque Wrench System



R-FMA



T-FMA

- 900 MHz frequency wireless error-proofing torque system
- For facilities that restrict the use of 2.4GHz
- Transmission Distance 10-20 Meters/30-60 Feet
- Easily change frequency with wireless setting box, SB-FMA
- Available on a wide variety of click type torque wrenches.

Transmitter, Receiver, and Setting Box

Model	Description	Specifications
T-FMA	Transmitter for R-FMA	900MHz (902.5 - 927.5MHz) 250kHz interval, 80CH, approx. 10 - 20m / 30 - 60 feet operating distance
R-FMA	Receiver for T-FMA	
SB-FMA	Setting box	

- Note
1. Radio frequency communication errors may be caused by noise or a shield placed between the transmitter and receiver. In addition, radio waves reflected by metal, concrete, etc. may interfere with radio waves directly sent to the antenna of the receiver and dead point occurs, resulting in communications errors.
 2. Available only in the United States and Canada.
 3. CSPFMA, QSPFMA model series are most popular.

FD/FDD

Click Type Torque Wrench with Wireless Data Transfer

Direction



CSPFD25N3X12D with QH



R-CM receiver with M-FD module



M-FD



BA-8R



FD-PCV



SB-FH2



FD/FDD Free setting software is provided

FD/FDD Common Outline



Display



OK



Wrench 1



Wrench 2



Multiple wrench control

Use 2 FD/FDD wrenches by One Receiver
Preset 2 points of Upper & Lower limit

R-CM controls up to two units of wrench and gives OK/Hi-NG/Lo-NG judgment for applied torque value from wrench No.1 and No.2. Receiver conducts judgment and sends answer back signal to the wrench with the result.

Use Multiple FD/FDD wrenches by One Receiver
Control each Upper & Lower limit by PC/PLC

An external device gives OK/Hi-NG/Lo-NG judgment for applied torque value from each wrench. R-CM receives the result from PC/PLC and sends answer back to each wrench.

Tightening Data Management System

- Transfer actual applied torque and wrench ID establish tightening traceability
- LED light offers simple visual judgment
- Interchangeable torque wrench type allows to use variety of standard heads
- FDD prevents double tightening counting by angle detection

Accuracy ±3%+1digit

Model		Torque Range [N·m]		Torque Range [kgf·m]		Torque Range [lbf·ft]		Overall Length [mm]	Weight [kg]	Head Size
FD	FDD	Min.-Max.	1 digit	Min.-Max.	1 digit	Min.-Max.	1 digit			
CSPFD25N3-10N×10D	CSPFDD25N3-10N×10D	2-10	0.1	kgf·m	kgf·m	lbf·ft	lbf·ft	193	0.32	10D
CSPFD25N3×10D	CSPFDD25N3×10D	5-25		0.2-1	0.01	3.6-18	0.1			
CSPFD50N3×12D	CSPFDD50N3×12D	10-50	0.2	1-5	0.02	7.5-36			214	0.46
CSPFD50N3×15D	CSPFDD50N3×15D						217			
CSPFD100N3×15D	CSPFDD100N3×15D	20-100	0.5	2-10	0.05	15-75	0.2	290	0.65	15D
CSPFD140N3×15D	CSPFDD140N3×15D	30-140		3-14		25-100	0.5	349	0.77	
CSPFD200N3×19D	CSPFDD200N3×19D	40-200	1	4-20	0.1	30-150	1	429	1.2	19D
CSPFD280N3×22D	CSPFDD280N3×22D	40-280		4-28		30-200		627	1.65	22D

- Note**
1. Interchangeable head is sold separately.
 2. The transmitter display shows 3 digit for torque value.
 3. FDD comes with double tightening detection function.
 4. Contact Tohnichi for status of wireless certification acquisition for each country.
 5. Ask to Tohnichi or distributor for any other torque range.

Standard Accessories Rechargeable AAA battery x 2 pcs, Protective Cover * Battery charger does not come with the set

Modular Conversion Receiver

Receiver	Specification
R-CM	Output: Relay x 4, RS232C, Input: LS-IN, Reset

Note Power source: DC24V

Connecting Cable

Part No.	Applicable Model	Specification
387	SB-FH2, R-CM - PC	RS232C straight

Protective Cover

Model	Applicable Model	Specification
FD-PCV	FD, FDD	Material: Silicon Resin

Radio Module

Model	Specification	Standard Accessory
M-FD	2.4GHz FHSS	Diversity antenna

Setting Box

Model	Available Setting Items	Dimension [mm]
SB-FH2	Group channel, Judgment code, 3-digit/7digit ID, Communication settings	W160 x D120 x H35

- Note**
1. Provide PC setting software
 2. RS232C straight cable needs optionally to use setting software.

FD/FDD Transmitter Specifications

Model	FD	FDD
Double Tightening Detection Angle Range		0 - 360°
LED	Blue: OK judgment for tightening torque Red: NG judgment for tightening torque Red flashing: Transmitting error	Blue: OK judgment for tightening torque and double tightening Red: NG judgment for tightening torque and double tightening Red flashing: Transmitting error
LCD Display	Tightening torque-3 digits, Torque unit, Battery level/4 levels	Tightening torque/angle convertible 3-digits, Torque unit, Battery level/4 levels
Operation Key	POWER key, TEST button, SET button	
Operating Time	24 hrs	12 hrs
Other Functions	Auto zero, Auto power off/0-99 minutes.	

FHSS, Frequency Hopping Spectrum System and 10 times of retry make communication reliability.

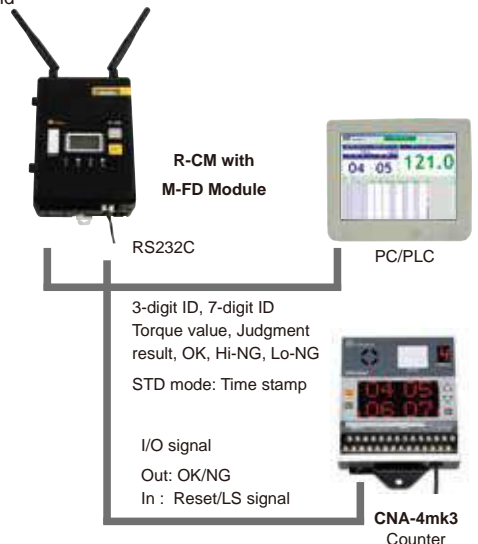

Note: Multiple wrenches can connect to one receiver as long as they do not signal at the exact same time.

FDD Double Tightening Detection Function

If the same fastener is tightened twice the second tightening data will be rejected.



Completion of tightening process with Blue signal.



LED lights Red when FDD wrench click on tightened bolt.

FDD-AD

Click Type Torque Wrench with Torque and Angle Data Transfer

Direction



CSPFD25N3X12D-AD with QH

Tightening Data Management System

- Transfer tightening peak torque and angle started from trigger torque
- Eliminating tightening error caused by bolt or application issues
- Interchangeable torque wrench type allows to use variety of standard heads

Accuracy ±3%+1digit

Model	Torque Range [N·m]		Torque Range [kgf·m]		Torque Range [lbf·ft]		Angle		Overall Length [mm]	Weight [kg]	Head Size
	Min.-Max.	1 digit	Min.-Max.	1 digit	Min.-Max.	1 digit	Range	Accuracy			
CSPFD25N3-10N×10D-AD	2-10	0.1	kgf·m	0.01	lbf·ft	0.1	0°-240° 1 digit: 1°	±2°+1 digit (Angular velocity is 30°/X-180°/s when the bolt turned to 90°)	193	0.32	10D
CSPFD25N3×10D-AD	5-25		kgf·m		lbf·ft				214	0.46	12D
CSPFD50N3×12D-AD	10-50	0.2	1-5	0.02	7.5-36	217			0.46	12D	
CSPFD50N3×15D-AD		0.2	2-10	0.05	15-75	290			0.65	15D	
CSPFD100N3×15D-AD	20-100	0.5	2-10	0.05	15-75	0.2			349	0.77	15D
CSPFD140N3×15D-AD	30-140	1	3-14	0.1	25-100	0.5			429	1.2	19D
CSPFD200N3×19D-AD	40-200		4-20		30-150	1	627	1.65	22D		
CSPFD280N3×22D-AD	40-280	1	4-28	0.1	30-200	1					

- Note**
1. Interchangeable head is sold separately.
 2. The transmitter display shows 3 digit for torque value.
 3. Contact Tohnichi for status of wireless certification acquisition for each country.
 4. Ask to Tohnichi or distributor for any other torque range.

Standard Accessories Rechargeable AAA battery x 2 pcs, Protective Cover * Battery charger does not come with the set

Modular Conversion Receiver

Receiver	Specification
R-CM	Output: Relay x 4, RS232C, Input: LS-IN, Reset

Note Power source: DC24V

Connecting Cable

Part No.	Applicable Model	Specification
387	SB-FH2, R-CM - PC	RS232C straight

Protective Cover

Model	Applicable Model	Specification
FD-PCV	FD, FDD, FDD-AD	Material: Silicon Resin

Radio Module

Model	Specification	Standard Accessory
M-FD	2.4GHz FHSS	Diversity antenna

Setting Box

Model	Available Setting Items	Dimension [mm]
SB-FH2	Group channel, Judgment code, 3-digit/7digit ID, Communication settings	W160 x D120 x H35

- Note**
1. Provide PC setting software
 2. RS232C straight cable needs optionally to use setting software.

FDD-AD Torque & Angle Data Transfer

By detecting final angle at the completion of the tightening operation, it is possible to eliminate tightening errors caused by provisional tightening, the tightening application or double tightening.

The receiver's set value can be changed by command input from PC / tablet depending on each tightening operation.

Detection of Tightening Error by Torque & Angle Monitoring

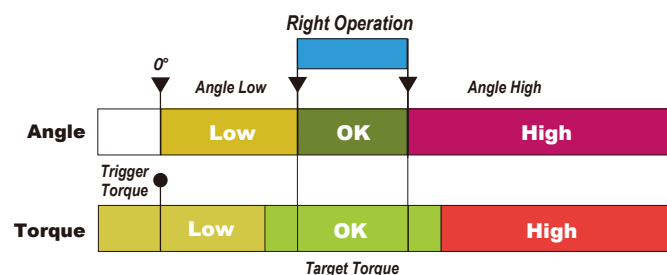

Angle Low

- ≡ Double Tightening
- ≡ Cross Threaded Screws
- ≡ Defect of work/Bolt
- ≡ Contamination

Angle High

- ≡ Defect of Work/Bolt
- ≡ Lack of O-Ring/Gasket
- ≡ Over torque of the provisional tightening

More Accurate with Angle function



Right Operation

Torque OK

Angle OK

Error Operation

Torque OK / NG

Angle NG

Torque & Angle OK



Torque or Angle, or Both NG



Answer Back

Converts Tohnichi format to NR Protocol
Integrates VIN info. Time stamp



R-CM Receiver
M-FD Module

Serial

Ethernet



TPC/TPC2 ver.1.3
Protocol Converter

- TPC standard Protocols
- 1.ACOP Serial
 - 2.ACOP Socket
 3. Stanley
 4. Request Custom Settings



Server

Note:

1. TPC-AD is special type of TPC protocol converter, refer to page 67 for standard.
2. ATLAS COPCO is registered trademark of Atlas Copco Aktiebolag
3. STANLEY is registered trademark of Stanley Logistics, LLC

CSPLD CSPLDC

Click Type Torque Wrench with Wired Data Transfer

Direction



CSPLD100N3X15D
with QH head and fixed cable



CD5

* CD5 Display is calibrated to one wrench.
(Purchase of CD5 is required.)



CSPLDC25N3X10D
with quick connect cable

Tightening Data Management System

- Transfer actual applied torque by cable connection with CD5 display
- CD5 display gives judgment for Hi/Lo set torque value
- Interchangeable torque wrench type allows to use variety of standard heads
- CD5 and wrench are calibrated together to one torque setting

Accuracy ±3%

Model		Torque Range [N·m]	Torque Range [kgf·cm/kgf·m]		Torque Range [lbf·in/lbf·ft]	
Fixed Cable	Quick Connect Cable	Min.-Max.	Min.-Max.	Min.-Max.	Min.-Max.	Min.-Max.
CSPLD	CSPLDC		kgf·cm	kgf·m	lbf·in	lbf·ft
CSPLD25N3-10N×10D	CSPLDC25N3-10N×10D	2-10	20-100	0.2-1	18-88	2.0-7.0
CSPLD25N3×10D	CSPLDC25N3×10D	5-25	50-250	0.5-2.5	45-221	4.0-18
CSPLD50N3×12D	CSPLDC50N3×12D	10-50	100-500	1-5	89-442	8.0-36
CSPLD50N3×15D	CSPLDC50N3×15D	20-100	200-1000	2-10	178-885	15-73
CSPLD100N3×15D	CSPLDC100N3×15D	30-140	300-1400	3-14	266-1239	23-103
CSPLD200N3×19D	CSPLDC200N3×19D	40-200	400-2000	4-20	355-1770	30-147
CSPLD280N3×22D	CSPLDC280N3×22D	40-280	400-2800	4-28	355-2478	30-206

- Note**
- 1 CSPLD/CSPLDC wrench and CD5 display are calibrated together. At time of order, provide torque set value and confirm cable types and length.
 - 2 Wrench only are supplied as back ups or for replacement. Calibration procedure required when connecting new wrench to CD5 Display. Contact Tohnichi for assistance.
 - 3 Interchangeable head is sold separately. Refer to page 45 to 48.
 - 4 If connecting CSPLD/CSPLDC to your existing CD5 display and use the OK/NG judgment LED light on the wrench, it requires a power supply AC adapter sold separately, contact to Tohnichi for details.

Display (Required)

Model	Dimension [mm]
CD5	W150 x D190 x H94

Note Refer to page 67 for more information.

CD5 Output Cable (Optional)

Model	Description	Plug
383	CD5 - PC	D-SUB Pin Female

CSPLD/CSPLDC Outline

Wired system features highly reliable transmitter mounted on a click torque wrench that captures actual applied torque data. CD5 display shows actual tightening torque and judgment is made whether or not the torque is within the programmed Hi/Lo parameters. Connect to PLC and PC software to store and control data for increased tightening reliability. Select from two different cable styles, CSPLD for fixed cable type and CSPLDC for quick connect type.

System Example



CSPLD

Wired transfer of actual tightening torque

Model AQSPLD2/AQSPLDC2/
ACQSPLD2/ACQSPLDC2,
AirTork versions are also available

Specify cable specification when ordering.
Refer to diagram bellows.

OK/NG judgment
Red: NG Blue: OK

Lighting in blue or red for the next use wrench by command input from PC/PLC



PC connecting cable/383
Refer to P.50.



PC/PLC

CSPLD/CSPLDC Cable Figure

Cable 1: 300mm Curled cable

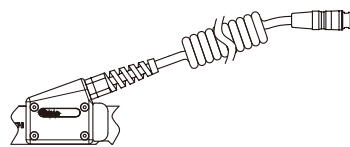

LD : Fixed cable type

Cable 2: 300mm Curled cable

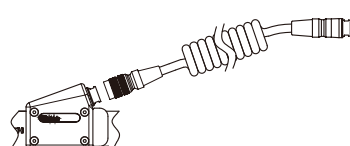

LDC : Quick connect type

Cable 3

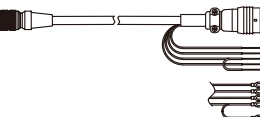

Connected to an indicator CD5

LS lead cable

LS lead cable with Y terminal

Cable 4



Cable 5 *Upon request



7 Pin Connector male



Note

- 1 Cable 1 : Fixed 300mm
- 2 Cable 3 : The length is selectable from 4 to 10m
- 3 Cable 4, Cable 5 : Available from 1 to 10m
- 4 Cable 5 is for connecting LD/LDC to the previous CSPD/ACQSPD cable from CD5. Select the connector shape depending on your CSPD.
- Standard "CSPD", Fixed Cable type : 7 Pin male
- "CSPD-KN", Quick Connector Type : 7 Pin female
- 5 For further details, contact Tohnichi.

TDMS

Tightening Data Management Software

Tightening Data Management Software

- For process control of tightening or inspection of each portion and fastener
- Connectable with Tohnichi products equipped with Bluetooth® module
- Statistic processing [N], [X-bar], [σ], [cp], and [cpk] for analysis of quality trends
- Ver 3.0 released, added angle data management function

TDMS Software Operation Example

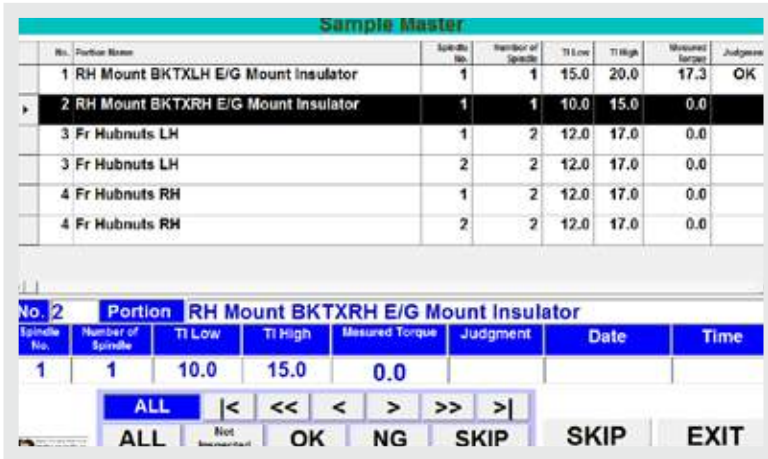

Operation screen

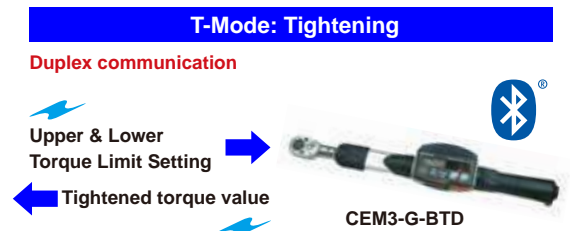
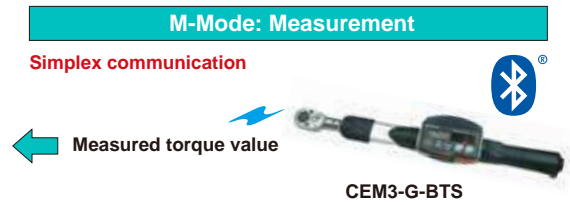

Refer to page 37 for CEM3-BTS, CEM3-BTD functions

TDMS shows the correct sequence of each operation process, including the upper and lower torque value for each fastener, then operator simply follows the instruction sequences shown on the screen. The collected data is linked to each fastener automatically eliminating the need to manually transcribe the information and prevents human error. In tightening T-Mode with CEM3-G-BTD, the software wirelessly transmits correct upper and lower limit according to each torque specification, so tightening management for various torque values is easy to control.

TDMS Software Data Base

Item Name	Sample Master				
Portion Name		Number of Spindle	TI Low	TI High	Tool No.
RH Mount BKTXLH E/G Mount Insulator		1	15.0	20.0	123456A
RH Mount BKTXRH E/G Mount Insulator		1	10.0	15.0	123456A
Fr Hubnuts LH		2	12.0	17.0	654321B
Fr Hubnuts RH		2	12.0	17.0	654321B

Portion Master Editing Excel Screen

Before use, input each parameters in Portion Master Excel file and save onto the PC where the TDMS is installed and then establish the Bluetooth communications with torque wrenches.

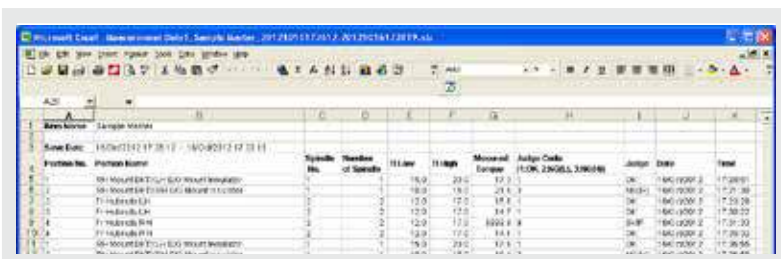

Measurement Data Master Excel

Measured data can be output by Excel format. TDMS performs statistic processing for each portion and fastener such as [N], [X-bar], [σ], [cp], and [cpk] for analysis of quality trends.

Customized software is available upon request with additional fees. Consult with Tohnichi for assistance.

Available Bluetooth® products for TDMS

M-Mode : Measurement operation

- CEM3-G-BTS
- CTB2-G-BT
- STC2-G-BT

T-Mode: Tightening operation

- CEM3-G-BTD, CEM3-G-BTA
- STC2-G-BT



STC2-G-BT



CTB2-G-BT

Model	Description	Language
TDMS	Software only	Japanese
TDMS-E		English
TDMS-C		Chinese

Note

1. Software installation is allowed on a single PC at one time.
2. Connectable with up to 7 Bluetooth® devices when using.
3. Excel® and Windows® is a trademark registration of Microsoft Co., Ltd.
4. Bluetooth® is a trademark registration of Bluetooth SIG, Inc.
5. CEM3-G-BTA and ST3-G-BT angle outut can be handled from the version 3.0

Standard Accessories

USB flash drive for portion master file management

System Requirements	
Operating System	Windows® XP, 7, 8, 8.1, 10

CEM3-G-BTS CEM3-G-BTD

Wireless Data Transfer
Digital Torque Wrench

Direction



CEM100N3×15D-G-BTS
CEM100N3×15D-G-BTD



* Bluetooth is a registered trademark of Bluetooth SIG, Inc.

CEM3-G-BTS

CEM3G-BTS Display

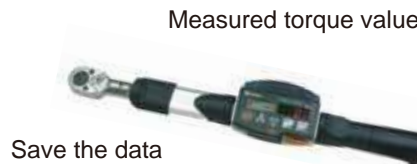
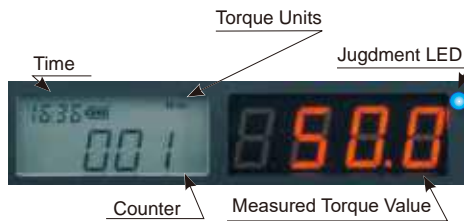

TDMS
or
Special made software

- Suitable for bolt inspection
- Transfer the realtime inspection record to PC/Tablet

CEM3-G-BTD

CEM3G-BTD Display

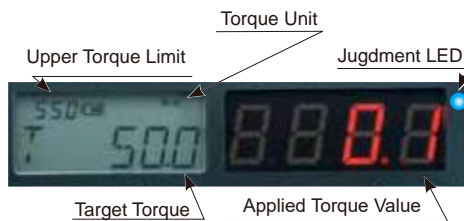

TDMS
or
Special made software

- Suitable for bolt tightening operation
- Change the preset target and upper limit torque by Bluetooth command input
- Preliminary alert at 80 % of the target torque
- Transfer realtime tightening data to PC/Tablet
(Data will not be saved in the wrench memory)

Applied torque value

CEM3-G-WF

Wireless LAN communication
data transfer digital torque wrench

Direction



CEM100N3×15D-G-WF



- 2.4/5GHz wireless LAN communication version of CEM3-G
- Conforming to the IEEE 802.11 wireless communication for LAN network
- Includes both simple and duplex functionality for tightening and inspection

Head Size	Model	Torque Range						Overall Length [mm]	Weight [kg]
		N-m		kgf-m		lbf-ft			
		Min.-Max.	1digit	Min.-Max.	1digit	Min.-Max.	1digit		
8D	CEM10N3×8D-G-WF	2-10	0.01	0.200-1.000	0.001	1.50-7.30	0.01	212	0.54
10D	CEM20N3×10D-G-WF	4-20	0.02	0.400-2.000	0.002	3.00-14.50	0.02	214	0.55
12D	CEM50N3×12D-G-WF	10-50	0.05	1.000-5.000	0.005	7.50-36.00	0.05	282	0.66
15D	CEM100N3×15D-G-WF	20-100	0.1	2.00-10.00	0.01	15.0-73.0	0.1	384	0.71
19D	CEM200N3×19D-G-WF	40-200	0.2	4.00-20.00	0.02	30.0-150.0	0.2	475	0.86
22D	CEM360N3×22D-G-WF	72-360	0.4	7.2-36.00	0.04	52.0-260.0	0.4	713	1.21
	CEM500N3×22D-G-WF	100-500	0.5	10.00-50.00	0.05	73.0-360.0	0.5	949	4.08
32D	CEM850N3×32D-G-WF	170-850	1	17.0-85.0	0.1	124-620	1	1387	5.22

- Note
1. For the specification, standard accessories and note of the basic CEM3-G model, refer to page 39.
 2. To use various functions, special software is required separately.
 3. Contact Tohnichi for status of wireless certification acquisition for each country

CEM3-G-WF Wireless LAN transmitter Specifications

Wireless Standard	IEEE 802. 11a/b/g/n	Authentication Method	WPA2
Frequency	11b/g/n: 2.4/5GHz 11b/g : 2.4/ 11n/a : 5GHz	Transmission Speed	11b: Max. 11Mbps 11a/g: Max. 54Mbps 11n: Max. 72.2Mbps
Modulation Method	11b: DSSS, 11a/g/n: OFDM	Communication Distance	Approx. 50m* *Veris in radio conditions
Protocol	TCP/IPv4	Acquisition of License	TELEC, FCC, IC, SRRC
Display	Power LED, Status LED		

CEM3-G-BTA

Wireless Data Transfer Digital Torque Wrench with Angle

Direction



CEM100N3x15D-G-BTA



Tightening Data Management System

- Transfer collected data wirelessly by built in Bluetooth® module
- Angle monitoring at the peak tightening torque or measured torque value
- Wireless duplex communication sends the Hi/Lo limit torque and angle settings to the wrench then sends the collected data back out to PC

Accuracy ±1%

Head Size	Model	Torque Range						Overall Length [mm]	Angle Range		Angle Accuracy	Weight [kg]
		N-m		kgf-m		lbf-ft			Min.-Max.	1 digit		
		Min.-Max.	1 digit	Min.-Max.	1 digit	Min.-Max.	1 digit					
8D	CEM10N3x8D-G-BTA	2-10	0.01	0.200-1.000	0.001	1.50-7.30	0.01	212			±2°+1 digit (Angular velocity is 30°/X-180°/s when the bolt turned to 90°)	0.54
10D	CEM20N3x10D-G-BTA	4-20	0.02	0.400-2.000	0.002	3.00-14.50	0.02	214				0.55
12D	CEM50N3x12D-G-BTA	10-50	0.05	1.000-5.000	0.005	7.50-36.00	0.05	282				0.66
15D	CEM100N3x15D-G-BTA	20-100	0.1	2.00-10.00	0.01	15.0-73.0	0.1	384	0-999°	1°		0.71
19D	CEM200N3x19D-G-BTA	40-200	0.2	4.00-20.00	0.02	30.0-150.0	0.2	475				0.86
22D	CEM360N3x22D-G-BTA	72-360	0.4	7.2-36.00	0.04	52.0-260.0	0.4	713				1.21
	CEM500N3x22D-G-BTA	100-500	0.5	10.00-50.00	0.05	73.0-360.0	0.5	949				4.08
32D	CEM850N3x32D-G-BTA	170-850	1	17.0-85.0	0.1	124-620	1	1387				5.22

- Note**
1. For the specification, standard accessories and note of the basic CEM3-G model, refer to page 39.
 2. Trigger torque can be set from the 5% of the maximum torque to the maximum.
 3. Trigger torque set below the minimum torque range of the body is not guaranteed.

By monitoring the final torque and the final angle, reliability for tightening and inspection data can be confirmed

For Inspection

Monitoring excessive or extremely small angle rotation during the re-tightening inspection will provide evidence for correct data verification.

M-Mode: Inspection

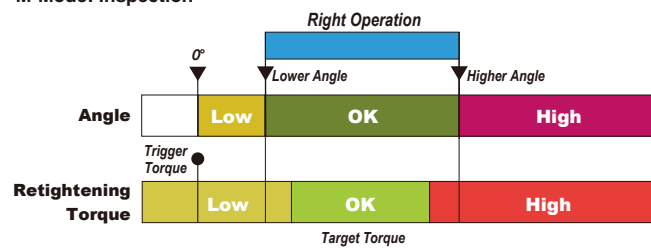

Possible causes of angle monitoring results

Angle Low

- Possibility of the operation errors
- Stopped loading before the bolt moving

Angle High

- Possibility of the operation errors
- Rotated too much on the retightening inspection process

Right Operation

- Torque OK, Angle OK
- Torque NG, Angle OK

Error Operation

- Torque OK / NG
- Angle NG

For Tightening

By detecting final angle at the completion of the tightening operation, it is possible to eliminate tightening errors caused by provisional tightening, the tightening application or double tightening.

Judgment Result Display

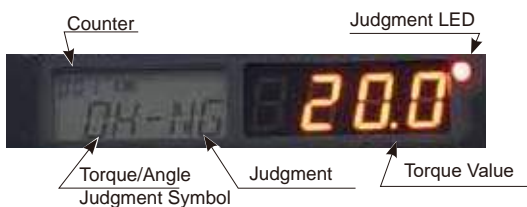

- L :Less than the lower limit (Low-NG)
- O :OK
- H :Beyond the upper limit (High-NG)
- D :Double tightening (NG tightening)

T-Mode: Tightening

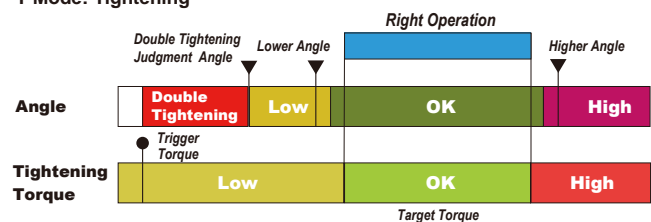

T-Mode: Double Tightening Detection

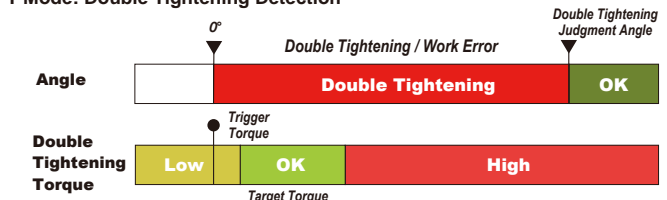

Possible causes of angle monitoring results

Angle Low

- Double Tightening
- Cross Threaded Screw
- Defect fo work/Bolt
- Contamination

Angle High

- Defect of Work/Bolt
- Lack of O-Ring/Gasket
- Over torque of the provisional tightening

Right Operation
Torque OK
Angle OK



Error Operation
Torque OK / NG
Angle NG

CEM3-G

DATA TORK/
Digital Torque
Wrench

- Inspection
- Digital
- Interchangeable
- Direct Reading
- Re-Chargeable
- ISO6789:2003

Direction



- Dual LED & LCD displays for optimal viewing
- 999 memory storage capacity
- For inspection and tightening



CEM100N3x15D-G



CEM20N3x10D-G



CEM850N3x32D-G

Common Specifications

Display	7 segments LED 4 lines 10mm (Torque value) 14 segments LCD 3 lines 7mm (Counter) 7 segments LCD 4 lines 3mm (Clock) Battery life indicator (4 steps) Judgment LED RED/BLUE
Number of Data Memory	999 (M-2 mode: 99 data)
Communication	RS232C (2400-19200bps)
Functions	Serial output corresponding to a USB connector
Power Supply	Ni-MH rechargeable battery
Continuous Use	20 hrs with fully charged (8 hours by 1 hour recharging)
Recharging Time	3.5 hours
Operating Temperature	0-40 °C
Basic Functions	Peak Hold, Auto memory & resetting, Tightening completion buzzer, Judgment of measured data, Auto zero setting, Auto off (3 minutes), Clock

Model	Torque Range										Hand Force [N]	Overall Length [mm]	Weight [kg]
	N-m		kgf-cm		kgf-m		lbf-in		lbf-ft				
	Min.-Max.	1digit	Min.-Max.	1digit	Min.-Max.	1digit	Min.-Max.	1digit	Min.-Max.	1digit			
CEM10N3x8D-G	2-10	0.01	20-100	0.1	0.200-1.000	0.001	20.0-90.0	0.1	1.50-7.30	0.01	48.1	212	0.46
CEM20N3x10D-G	4-20	0.02	40-200	0.2	0.400-2.000	0.002	36.0-180.0	0.2	3.00-14.50	0.02	92.2	214	0.47
CEM50N3x12D-G	10-50	0.05	100-500	0.5	1.000-5.000	0.005	100.0-440.0	0.5	7.50-36.00	0.05	196.9	282	0.58
CEM100N3x15D-G	20-100	0.1	200-1000	1	2.00-10.00	0.01	200-880	1	15.0-73.0	0.1	275.5	384	0.63
CEM200N3x19D-G	40-200	0.2	400-2000	2	4.00-20.00	0.02	360-1700	2	30.0-150.0	0.2	428.3	475	0.78
CEM360N3x22D-G	72-360	0.4	720-3600	4	7.2-36.00	0.04	650-3100	4	52.0-260.0	0.4	498.6	713	1.13
CEM500N3x22D-G	100-500	0.5	1000-5000	5	10.00-50.00	0.05	890-4400	5	73.0-360.0	0.5	549.5	949	4.00
CEM850N3x32D-G	170-850	1	-	-	17.0-85.0	0.1	-	-	124-620	1	608	1387	5.14

Accuracy ±1%

- Note**
1. Overall length does not include interchangeable head.
 2. For interchangeable head, refer to page 45-48.
 3. For infrared data transfer, use with R-DT999. Refer to page 70.
 4. PH Pipe wrench head type interchangeable head is not available for this model.
 5. CEM500N3x22D-G and CEM850N3x32D-G have knurled handles.
 6. For USB data transfer, use optional connecting cable, No.584. Refer to page 50.

- Standard Accessories**
1. Battery pack/BP-5
 2. QH interchangeable head. Refer to page 47.
 3. Quick battery charger/BC-3-G (100-240V).

CEM3-P RoHS

- Programmable version of CEM3-G with data management software that links work name with test results.

Torque Accuracy	±1%
Portion Registration Memory	Max. 100 parts (Part name, number of screws, tightening direction, high/low torque, measuring order)
Measurement Data Storage	Up to 3,000 screw data (vary depending on parts registered), measurement part name, measured value, pass/fail judgment, measurement time and date)



CEM50N3x12D-P



Display part
Left: Part name, Right: Torque value



CEM3-P application software

Model
CEM10N3x8D-P
CEM20N3x10D-P
CEM50N3x12D-P

Model
CEM100N3x15D-P
CEM200N3x19D-P
CEM360N3x22D-P

Model
CEM500N3x22D-P
CEM850N3x32D-P

Battery Pack (P.50)

Model
BP-5

Quick Battery Charger (P.50)

Model	Description
BC-3-G	100V-240V

Printer (P.69)

Model
EPP16M3

Connecting Cable (P.50)

Part #	Applicable Model
575	CEM3-G, CEM3-P, R-DT999 - PC, EPP16M3
584	CEM3-G, CEM3-P, R-DT999G - PC

Data Filing System (P.69)

Model	Media
DFS	CD-ROM

Handy Terminal

Compact data collection device for CEM3-G

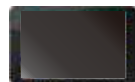

- Upload & download torque measuring information
- Guides user through torque assembly & quality inspection processes
- Statistics and charting capabilities
- Contact Tohnichi for lithium battery shipping specifications.

CTB2-G Digital Retightening Torque Wrench

Direction



RoHS



CTB100N2x15D-G



CTB850N2x32D-G

Inspection	Digital	Interchangeable	Signal	Re-Chargeable	ISO6789:2003
------------	---------	-----------------	--------	---------------	--------------

- Detects movement of fastener for more accurate testing
- For quality inspection applications, confirms previously tightened torque values.

Accuracy ±1%

Model	Torque Range										Hand Force [N]	Overall Length [mm]	Weight [kg]
	N·m		kgf·cm		kgf·m		lbf·in		lbf·ft				
	Min.-Max.	1digit	Min.-Max.	1digit	Min.-Max.	1digit	Min.-Max.	1digit	Min.-Max.	1digit			
CTB10N2x8D-G	2-10	0.01	20-100	0.1	0.2-1	0.001	20-90	0.1	1.5-7.3	0.01	48.1	212	0.46
CTB20N2x10D-G	4-20	0.02	40-200	0.2	0.4-2	0.002	36-180	0.2	3-14.5	0.02	92.2	214	0.47
CTB50N2x12D-G	10-50	0.05	100-500	0.5	1-5	0.005	100-440	0.5	7.5-36	0.05	196.9	282	0.58
CTB100N2x15D-G	20-100	0.1	200-1000	1	2-10	0.01	200-880	1	15-73	0.1	275.5	384	0.63
CTB200N2x19D-G	40-200	0.2	400-2000	2	4-20	0.02	360-1700	2	30-150	0.2	428.3	475	0.78
CTB360N2x22D-G	72-360	0.4	720-3600	4	7.2-36	0.04	650-3100	4	52-260	0.4	498.6	713	1.13
CTB500N2x22D-G	100-500	0.5	1000-5000	5	10-50	0.05	890-4400	5	73-360	0.5	549.5	949	4.00
CTB850N2x32D-G	170-850	1	-	-	17-85	0.1	-	-	124-620	1	608	1387	5.14

- Note**
1. Overall length does not include interchangeable head.
 2. For interchangeable head, refer to page 45-48.
 3. For infrared data transfer, use with R-DT999. Refer to page 69.
 4. PH type interchangeable head is not available for this model.

- Standard Accessories**
1. Battery pack/BP-5
 2. QH interchangeable head (P.47).
 3. Quick battery charger/BC-3-G, 100-240V

Common Specifications

Data Memory	999 data (T-point torque)
Arithmetic Function	Sampling, Maximum, Minimum, Means
Measurement Mode	Peak/Run
Data Output	RS232C I/F, USB serial output
Zero Adjustment	Auto zero function (C key)
Other Function	Auto power off (3 min./10 min./30 min./non)
Power Source	Ni-MH Nickel metal-hydride battery
Continuous Use	20 hours (8 hours by 1 hour charging)
Battery Charge	3.5 hours
Operating Temperature	0-40 °C

Battery Pack (P.50)

Model
BP-5

Printer (P.69)

Model
EPP16M3

Quick Battery Charger (P.50)

Model	Description
BC-3-G	100-240V

Connecting Cable (P.50)

Part #	Applicable Model
575	CTB2-G - PC, EPP16M3
584	CTB2-G, R-DT999G - PC

Data Filing System (P.69)

Model	Media
DFS	CD-ROM

Advantages of the New Retightening Method: T-point Method

- Anyone can measure the tightening torque easily.
- Requires less time to perform the measurement.
- Dispersion of data is small (Figure-3).
- No individual interpretation or performance variable is involved in measuring the torque (Figure-3).
- Internal software converts measured torque to initial tightening torque value (Figure-3).

Figure-1 Traditional retightening torque method

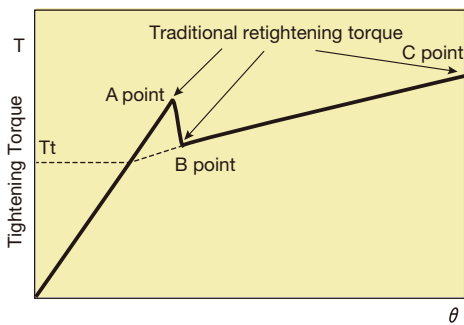

Retightening Torque Method

Retightening torque method aims to measure the torque at which a tightened bolt start to rotate again as further torque is applied. The retightening measured values are classified as one of these three kinds:

- The torque which overcome the static friction of the bolt (A point).
- The torque at which the bolt starts on turn continuously (B point).
- The maximum torque at this inspection (C point).

Proposal of T-point method (Figure-2)

Retightening torque first starts with the rotation of the head only, then the screw starts to rotate. Shifting from static friction to dynamic friction, the friction whip settles and the torque starts to increase at the steady pace again. T-point method figures TT as retightening torque value.

Figure-2 New retightening torque method by CTB2-G

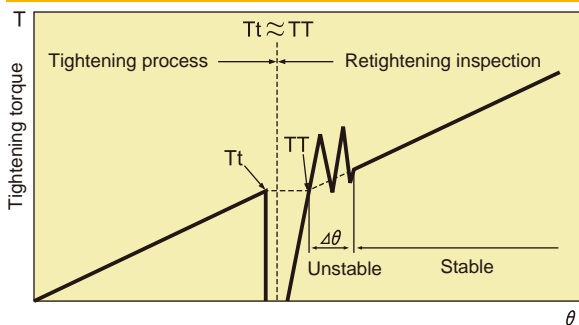
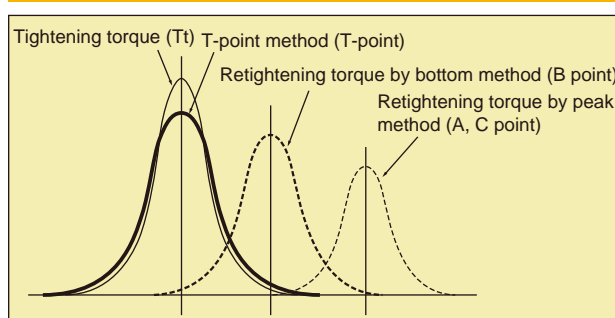

Figure-3 Distribution of retightening torque



Refer to Tohnichi Torque Handbook Vol. 9 on page 46 to 47 for the details.



DB/DBE/DBR

Direction Dial Indicating Torque Wrench



RoHS



DB12N4



DB100N



DBE700N



Memory Pointer, Red color point

DB Optional Accessories



846

Carrying Case (P.49)

Part #	Applicable Model Dimension [mm]	Weight [kg]
846	DB100N-S, CDB100N×15D-S or less H170 × W500 × D100	1.0
847	DB280N-S, CDB280N×22D-S or less H170 × W740 × D100	1.6

Inspection | Dial Indicating | Direct Reading | ISO6789:2003
2017

- Memory pointer for easy torque reading
- Ideal for torque measuring and quality check applications

Accuracy ±3%

S.I. Model	Torque Range [N·m/kN·m]		Metric Model	Torque Range [kgf·cm/kgf·m]		American Model	Torque Range [lbf·in/lbf·ft]		Overall Length [mm]	Square Drive [mm]	Weight [kg]
	Min.-Max.	Grad.		Min.-Max.	Grad.		Min.-Max.	Grad.			
DB1.5N4-S	0.2-1.5	0.02	15DB4-S	2-15	0.2	DB13I-2AS	0-13	0.2			
DB3N4-S	0.3-3	0.05	30DB4-S	3-30	0.5	DB26I-2AS	0-26				
DB6N5-S	0.7-6	0.1	DB60M5-S	7-60	1	DB40I-2AS	0-40		205	6.35	0.4
DB12N5-S	1.4-12	0.2	DB120M5-S	14-120	2	DB75I-2AS	0-75	1			
DB25N5-1/4-S	3.5-25		DB250M5-1/4-S	35-250		DB150I-2AS	0-150	2	245		
DB25N5-S			DB250M5-S			DB150I-3AS					
DB50N-S	5-50	0.5	DB500M-S	50-500	5	DB300I-3AS	0-300	5			0.6
						DB25F-3AS	0-25	0.5		9.5	
						DB600I-3AS	0-600	10			
DB100N-3/8-S			DB1000M-3/8-S								
						DB50F-3AS	0-50	0.5			
	10-100	1		100-1000	10				400		0.7
						DB600I-4AS	0-600	10			
DB100N-S			DB1000M-S								
						DB50F-4AS	0-50	0.5			
DB200N-S	20-200	2	DB2000M-S	200-2000	20	DB100F-4AS	0-100	1	500	12.7	
				kgf·m	kgf·m						1.0
						DB175F-4AS	0-175	2	580		
DB280N5-1/2-S	35-280		DB2800M5-1/2-S	3.5-28						690	1.65
DB280N5-S			DB2800M5-S			DB250F-6AS	0-250				
DB420N-S	40-420	5	DB4200M-S	4-42	0.5	DB350F-6AS	0-350	5		890	2.5
DBE560N-S	50-560		DBE5600M-S	5-56						1100	4.0
DBE700N-S	70-700		DBE7000M-S	7-70		DB500F-6AS	0-500	10	1260		5.5
DBE850N-S	100-850	10	DBE8500M-S	10-85	1					1360	6.1
DBE1000N-S	100-1000		DBE10000M-S	10-100						1490	6.4
DBE1400N-S	200-1400	20	DBE14000M-S	20-140	2	DB1000F-8AS	0-1000			1740	8.6
DBE2100N-S	200-2100		DBE21000M-S	20-210		DB1500F-8AS	0-1500			2140	12.8
DBE2800N5-S	350-2800	50	DBE28000M5-S	35-280		DB2000F-12AS	0-2000	20		2380	16.8
											38.1
DBR4500N-S	0.5-4.5	0.05	45000DBR-S	50-450	5	DB3000F-12AS	0-3000	50	1285		26.5
DBR6000N-S	0.6-6	0.1	60000DBR-S	60-600					1585	44.5	27.5

- Note**
1. "Without memory pointer" models are available. Remove "-S" from the model name when ordering.
Ex. DB100N
 2. DBR models require winch or mechanical loading device.
 3. DBR Models are supplied upon request.
 4. For models having over 25.4mm square drive, use with a through-hole socket.
 5. Accuracy of American models is warranted from 20% of max. torque.
 6. DB1.5N4, DB3N4 and the equivalent metric models, American unit models come with ISO6789-2003 certificate.

Torque Wrench for Quality Inspection

CDB-S

Interchangeable Head Type Dial Indicating Torque Wrench

Direction

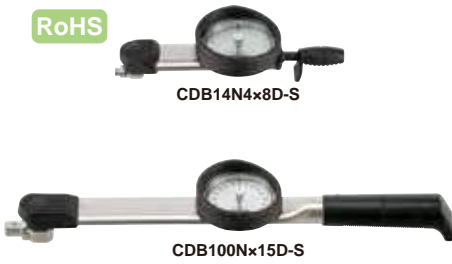

Inspection | Dial Indicating | Interchangeable | Memory Pointer | ISO6789:2003/2017

- Interchangeable head version of DB
- Ideal for torque measuring and quality inspections

Accuracy ±3%

Head Size	S.I. Model	Torque Range [N·m]		Metric Model	Torque Range [kgf·cm/kgf·m]		American Model	Torque Range [lbf·in/lbf·ft]		Overall Length [mm]	Weight [kg]
		Min.-Max.	Grad.		Min.-Max.	Grad.		Min.-Max.	Grad.		
8D	CDB7N4x8D-S	0.7-7	0.1	CDB70Mx8D-S	7-70	1	70CDB4-A-S	6-60	1	215	0.45
	CDB14N4x8D-S	2-14	0.2	CDB140Mx8D-S	20-140	2	140CDB4-A-S	20-120	2		
10D	CDB25N5x10D-S	3.5-25	0.5	CDB250M5x8D-S	35-250	5	250CDB-A-S	30-220	5	255	0.48
12D	CDB50Nx12D-S	5-50		CDB500Mx12D-S	50-500		500CDB-A-S	40-430		330	
15D	CDB100Nx15D-S	10-100	1	CDB1000Mx15D-S	100-1000	10	1000CDB-A-S	7-70	1	415	0.76
19D	CDB200Nx19D-S	20-200	2	CDB2000Mx15D-S	200-2000	20	2000CDB-A-S	14-140	2	525	
22D	CDB300N5x22D-S	35-300	5	CDB300M5x22D-S	3.5-30	0.5	3000CDB-A-S	20-220	5	720	1.65
	CDB420Nx22D-S	40-420		CDB4200Mx22D-S	4-42		4200CDB-A-S	30-300		920	

- Note
1. Overall length does not include interchangeable head.
 2. PH (Pipe wrench head) type interchangeable head is not available.
 3. Interchangeable heads are optional.
 4. American models come with ISO:6789-2003 certificate.

SCDB-S

European Style Interchangeable Head Type Dial Indicating Torque Wrench

Direction



Inspection | Dial Indicating | Interchangeable | Memory Pointer | ISO6789:2017

- Specialized version of DB
- Accepts DIN interchangeable head connection

Accuracy ±3%

S.I. Model	Torque Range [N·m]		Head Size [mm]	Overall Length [mm]	Weight [kg]
	Min.-Max.	Grad.			
SCDB25N5-9x12-S	3.5-25	0.5	9x12	271	0.48
SCDB50N-9x12-S	5-50		9x12	342	0.53
SCDB100N-9x12-S	10-100	1	9x12	422	0.76
SCDB200N-14x18-S	20-200	2	14x18	535	1

- Note
1. Overall length does not include interchangeable head.
 2. Applicable to European style head. Tohnichi's interchangeable heads are not available for SCDB-S.

T-S

T-Handle Dial Indicating Torque Wrench

Direction



Inspection | Dial Indicating | Direct Reading | Memory Pointer | ISO6789:2003/2017

- Dual handle for increased stability
- Memory pointer for easy reading

Accuracy ±3%

S.I. Model	Torque Range [N·m]		Metric Model	Torque Range [kgf·cm/kgf·m]		American Model	Torque Range [lbf·in/lbf·ft]		Overall Length [mm]	Neck Length [mm]	Square Drive [mm]	Weight [kg]
	Min.-Max.	Grad.		Min.-Max.	Grad.		Min.-Max.	Grad.				
T23N2-S	3.5-23	0.5	T230M2-S	35-230	5	T200I-3AS	20-200	2	205	71	9.5	0.41
T45N-S	5-45		T450M-S	50-450		T400I-3AS	50-400	5	261	82		0.53
T90N-S	10-90	1	T900M-S	100-900	10	T65F-4AS	10-65	1	376	102.5	12.7	0.8
T180N-S	20-180	2	T1800M-S	200-1800	20	T130F-4AS	20-130	2	656	118.5		1.2
T700N-S	70-700	10	7000T-S	7-70	1	7000T-A-S	50-500	5	1300	19.0	4	
T1000N-S	100-1000		10000T-S	10-100		10000T-A-S	50-700		1630		4.8	
T1400N-S	200-1400	20	14000T-S	20-140	2	14000T-A-S	100-1000	10	1880	25.4	6.2	
T2100N-S	200-2100		21000T-S	20-210		21000T-A-S	200-1500		2500		10	
T2800N-S	300-2800	50	28000T-S	30-280	5	28000T-A-S	200-2000	20	2960	38.1	15.5	
T4200N-S	400-4200		42000T-S	40-420		42000T-A-S	400-3000		3660		21.5	

- Note
1. T700N-S to T4200N-S models are supplied upon request.
 2. For models having over 25.4mm square drive, use with a through-hole socket.
 3. American models come with ISO:6789-2003 certificate.

Torque Wrench for Quality Inspection



SF/F/FR

Beam Type Torque Wrench

Direction



RoHS



SF6N



F92N

Inspection Beam Direct Reading ISO6789:2003

- Direct reading torque wrench with scale plate
- For measuring and tightening applications

Accuracy ±3%

S.I. Model	Torque Range [cN-m/N-m]		Metric Model	Torque Range [kgf-cm/kgf-m]		American Model	Torque Range [lbf-in/lbf-ft]		Overall Length [mm]	Square Drive [mm]	Weight [kg]
	Min.-Max.	Grad.		Min.-Max.	Grad.		Min.-Max.	Grad.			
SF40CN	8-40		4SF	0.8-4		4SF-A	0.3-4		115		0.04
SF70CN	10-70	2	7SF	1-7	0.2	7SF-A	0-6	0.2	135		0.05
SF1.5N	0.2-1.5	0.05	15SF	2-15	0.5	15SF-A	0-13	0.5	145	6.35	0.07
SF3N	0.5-3	0.1	30SF	5-30	1	30SF-A	0-26	1	175		0.09
SF6N	0.6-6	0.2	60SF	6-60	2	60SF-A	0-50	2	205		0.2
SF12N	2-12		120SF	20-120		120SF-A	0-100		235		0.25
F23N	3-23	0.5	230F	30-230	5	230F-A	0-200	5	295	9.5	0.4
F46N	5-46	1	460F	50-460	10	460F-A	0-400	10	355		0.6
F92N	10-92		920F	100-920		920F-A	10-66		400		0.95
F130N	20-130	2	1300F	200-1300	20	1300F-A	10-95	2	445	12.7	1.2
F190N	30-190		1900F	300-1900	50	1900F-A	25-135		490		1.5
F280N	50-280	5	2800F	5-28	0.5	2800F-A	30-200	5	565		2.2
F420N	70-420		4200F	7-42		4200F-A	30-300		825	19.0	3.5
F560N	100-560	10	5600F	10-56	1	5600F-A	50-400	10	945		4.0
F700N	100-700		7000F	10-70		7000F-A	50-500		1175		6.0
F850N	100-850		8500F	10-85		8500F-A	60-600		1410		7.8
F1000N	100-1000		10000F	10-100		10000F-A	70-700		1640		8.8
FR1050N	100-1050	20	10500FR	10-105	2	10500FR-A	100-750	20	835	25.4	8
FR1400N	200-1400		14000FR	20-140		14000FR-A	100-1000		981		11.5
FR2100N	300-2100	50	21000FR	30-210	5	21000FR-A	200-1500	50	1148		14.5
FR2800N	300-2800		28000FR	30-280		28000FR-A	200-2000		1292		20
FR4200N	400-4200	100	42000FR	40-420	10	42000FR-A	300-3000	100	1460	38.1	28
FR6000N	600-6000		60000FR	60-600		60000FR-A	400-4300		1624		30

- Note
1. FR models are supplied upon request.
 2. FR models require winch or mechanical loading device.
 3. For models having over 25.4mm square drive, use with a through-hole socket.
 4. Accuracy of American models is warranted from 20% of max. torque.

CSF/CF

Interchangeable Head Type Beam Type Torque Wrench

Direction



RoHS



CSF7Nx8D



CF25Nx10D

Inspection Beam Interchangeable Direct Reading ISO6789:2003

- Interchangeable head version of SF/F
- For measuring and tightening applications

Accuracy ±3%

Head Size	S.I. Model	Torque Range [N-m]		Metric Model	Torque Range [kgf-cm/kgf-m]		American Model	Torque Range [lbf-in/lbf-ft]		Overall Length [mm]	Weight [kg]
		Min.-Max.	Grad.		Min.-Max.	Grad.		Min.-Max.	Grad.		
8D	CSF7Nx8D	1-7	0.2	70CSF	10-70	2	70CSF-A	10-60	2	220	0.2
	CSF14Nx8D	2-14	0.5	140CSF	20-140	5	140CSF-A	20-120	5	250	0.25
	CF25Nx10D	5-25	1	250CF	50-250	10	250CF-A	40-220	10	320	0.4
12D	CF50Nx12D	10-50		500CF	100-500		500CF-A	80-420	20	380	0.6
			2			20		lbf-in lbf-ft			
15D	CF100Nx15D	10-100		1000CF	100-1000		1000CF-A	6-70	2	435	1.0
19D	CF150Nx19D	20-150		1500CF	200-1500	50	1500CF-A	15-110		480	1.3
			5		kgf-m	kgf-m			5		
22D	CF230Nx22D	30-230		2300CF	3-23	0.5	2300CF-A	20-160		530	1.6
	CF420Nx22D	70-420	10	4200CF	7-42	1	4200CF-A	30-300		725	3.1
32D	CF850Nx32D	100-850	20	8500CF	42-85	2	8500CF-A	60-600	20	1260	7.1

- Note
1. Overall length does not include interchangeable head.
 2. PH (Pipe wrench head) type interchangeable head is not available.
 3. Interchangeable heads are optional.

QF/QFR

Ratchet Head Beam Type Torque Wrench

Direction



RoHS



QF120N

Inspection Beam Ratchet Head Direct Reading ISO6789:2003

- Fixed ratchet head flat beam style
- Ideal for working in narrow spaces

Accuracy ±3%

S.I. Model	Torque Range [N-m]		Metric Model	Torque Range [kgf-cm/kgf-m]		American Model	Torque Range [lbf-in/lbf-ft]		Overall Length [mm]	Square Drive [mm]	Weight [kg]
	Min.-Max.	Grad.		Min.-Max.	Grad.		Min.-Max.	Grad.			
QF60N	6-60	1	600QF	60-600	10	600QF-A	0-520	10	455	9.5	0.8
QF120N	10-120	2	1200QF	100-1200	20	1200QF-A	6-86	2	515	12.7	1.2
QF220N	30-220	5	2200QF	300-2200	50	2200QF-A	25-160		580		1.8
				kgf-m	kgf-m						
QF320N	60-320		3200QF	6-32		3200QF-A	40-230		655		2.6
QF420N	70-420		4200QF	7-42		4200QF-A	30-300		825		3.4
QF560N	100-560	10	5600QF	10-56	1	5600QF-A	50-400		950	19.0	4.3
QF700N	100-700		7000QF	10-70		7000QF-A	50-500	10	1170		6.5
QF850N	100-850		8500QF	10-85		8500QF-A	60-600		1400		8.5
QFR1050N	100-1050	20	10500QFR	10-105	2	10500QFR-A	100-750	20	845	25.4	8.5
QFR1400N	200-1400		14000QFR	20-140		14000QFR-A	100-1000		992		12.5
QFR2100N	300-2100		21000QFR	30-210		21000QFR-A	200-1500		1158		15.5
QFR2800N	300-2800	50	28000QFR	30-280	5	28000QFR-A	200-2000	50	1305		21
QFR4200N	400-4200		42000QFR	40-420		42000QFR-A	300-3000		1473	38.1	30
QFR6000N	600-6000	100	60000QFR	60-600	10	60000QFR-A	400-4300		1624		32

- Note
1. QFR models are supplied upon request.
 2. QFR models require winch or mechanical loading device.
 3. For models having over 25.4mm square drive, use with a through-hole socket.

Interchangeable Socket

SOCKET FOR HAND TOOL

		From Torque Tool			
Inlet Drive (Female)		6.35	9.5	12.7	19.0
Width Across Flats (B)		2H	3H	4H	6H
From Bolt	8	201			
	10	202	210		
	12	203	211		
	13	204	212		
	14		213	220	
	16		216	227	
	17		214	221	
	18		217	228	
	19		215	222	
	21			229	237
	22			223	230
	24			224	231
	27			225	232
	30			226	233
	32				234
	34				236
	36				235
	41				
46					
50					
55					

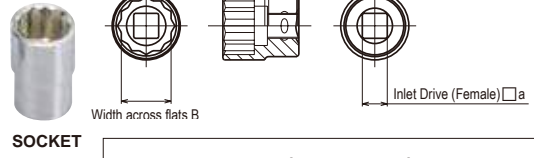

SOCKET FOR HAND TOOL

Indicate model name and Part #

[Ex.] SOCKET **2H-10** **202**
 Socket Inlet sign Purpose sign Width across flats Part #

ADAPTER

Indicate model name and Part #

[Ex.] ADAPTER **2H-3** **270**
 Inlet Sign (Female) Purpose sign Inlet sign (Male) Part #

ADAPTER FOR HAND TOOL

		From Torque Tool			
Inlet Drive (Female)		6.35	9.5	12.7	19.0
Inlet Drive (Male)		2H	3H	4H	6H
To Socket	6.3 (2)		271		
	9.5 (3)	270		273	
	12.7 (4)	277	272		275
	19 (6)			274	
	25.4 (8)				276

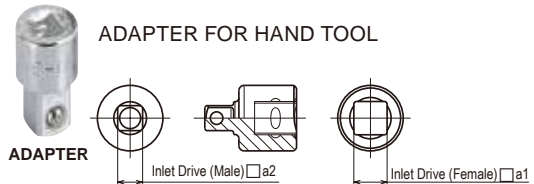

ADAPTER FOR HAND TOOL

SOCKET FOR PNEUMATIC TOOL

		From Torque Tool		
Inlet Drive (Female)		9.5	12.7	25.4
Width Across Flats (B)		3P	4P	8P
From Bolt	10	250		
	12	251		
	13	252		
	14	253	260	
	16	255	264	
	17	254	261	
	18		265	
	19		262	
	21		266	
	22		263	
	32			303
	34			304
	36			305
	41			306
	46			307
	50			308
	55			309



SOCKET

SOCKET FOR PNEUMATIC TOOL

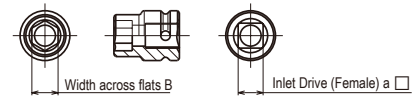

SOCKET FOR PNEUMATIC TOOL

Indicate model name and Part #

[Ex.] SOCKET **3P-10** **250**
 Socket Inlet sign Purpose sign Width across flats Part #

ADAPTER

Indicate model name and Part #

[Ex.] ADAPTER **3P-4** **290**
 Inlet Sign (Female) Purpose sign Inlet sign (Male) Part #

Note O-ring and pin are included.

ADAPTER FOR PNEUMATIC TOOL

		From Torque Tool			
Inlet Drive (Female)		9.5	12.7	19.0	25.4
Inlet Drive (Male)		3P	4P	6P	8P
To Socket	9.5 (3)		291		
	12.7 (4)	290		293	
	19 (6)		292		295
	25.4 (8)			294	

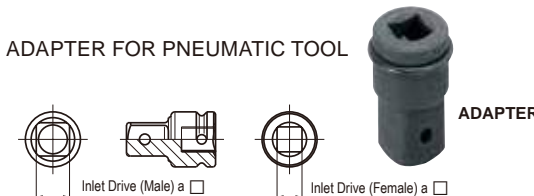

ADAPTER FOR PNEUMATIC TOOL

SOCKET FOR POWER AND HAND TOOL

		From Torque Tool			
Inlet Drive (Female)		6.35	9.5	12.7	19.0
Width Across Flats (B)		2C	3C	4C	6C
From Bolt	2.5	430			
	3	431	440		
	4	432	441		
	5		442		
	6		443	450	
	8			451	
	10			452	
	12			453	
	14			454	460
	17				461
	19				462

SOCKET FOR HEX HEAD CAP SCREWS

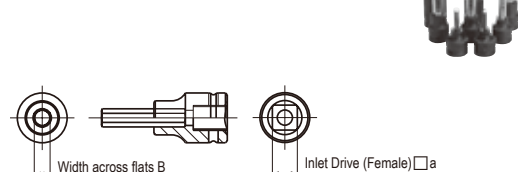

Note 1. O-ring and pin are included in the inlet drive 9.5 to 19.0 socket.
 2. 430, 431, 432 are not through hole type.



Interchangeable Head

SH

Open Spanner Head

RoHS

The SH type spanner heads suit for the place where sockets can not be used, for flare nuts in piping and for work in narrow places.

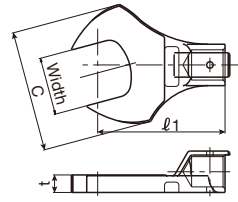

SH15Dx19

Tohnichi Head Size	Model (Body Size x Width)	Allowable Torque		Outside Width C [mm]	Thickness t [mm]
		[N·m]	[kgf·cm]		
8D	SH8Dx5.5	1.5	15	13	3
	SH8Dx6	2.5	25	15	3.5
	SH8Dx7	3.5	35	17	4
	SH8Dx8	7	70	20	4.5
	SH8Dx10	14	140	25	5.5
	SH8Dx11			27	
	SH8Dx12			29	6.5
	SH8Dx13				
	SH8Dx14			31	6.5
	SH8Dx16	15	150		
	SH8Dx17			32	
	SH8Dx19			35	
	SH8Dx21			36	
	SH8Dx22			37	
SH8Dx24			38		
10D	SH10Dx7	20	200	28	6.5
	SH10Dx8				
	SH10Dx10				
	SH10Dx11				
	SH10Dx12				
	SH10Dx13			32	
	SH10Dx14				
	SH10Dx16				
	SH10Dx17	25	250		
	SH10Dx18			39	
SH10Dx19					
SH10Dx21					
SH10Dx22					
SH10Dx24			43		
12D	SH12Dx8	7	70	20	5
	SH12Dx10	12	120	24	
	SH12Dx11	20.5	205	28	5.5
	SH12Dx12	29.5	295	31	6.5
	SH12Dx13			32	
	SH12Dx14			38	8
	SH12Dx16	59	590		
	SH12Dx17			40	10
	SH12Dx18				
	SH12Dx19			41	11
SH12Dx21	70	700			
SH12Dx22			43		
SH12Dx24			48	13	
SH12Dx27			52		
15D	SH15Dx12	59	590	38	8
	SH15Dx13				
	SH15Dx14				
	SH15Dx16				
	SH15Dx17				
	SH15Dx18	140	1400	51	13
	SH15Dx19				
	SH15Dx21				
SH15Dx22					

Tohnichi Head Size	Model (Body Size x Width)	Allowable Torque		Outside Width C [mm]	Thickness t [mm]
		[N·m]	[kgf·cm]		
15D	SH15Dx24	140	1400	60	12
	SH15Dx26				
	SH15Dx27				
	SH15Dx30				
	SH15Dx32				
SH15Dx36			68		
SH19Dx17					
SH19Dx18	200	2000			
SH19Dx19			54	13	
SH19Dx21					
SH19Dx22	180	1800			
SH19Dx24					
SH19Dx27	200	2000	60	15	
SH19Dx30	180	1800			
SH19Dx32					
SH19Dx34	200	2000	76	11	
SH19Dx36					
SH19Dx41	180	1800			
SH22Dx19					
SH22Dx22	280	2800	63		
SH22Dx24	500	5000			
SH22Dx27					
SH22Dx30	420	4200	78		
SH22Dx32					
SH22Dx34	500	5000		15	
SH22Dx36	420	4200			
SH22Dx41			85		
SH22Dx46	280	2800			
SH22Dx50			103		
SH22Dx55	500	5000	108		
SH27Dx22	255	2550	65	14	
SH27Dx24	350	3500	72	15	
SH27Dx27	490	4900	82	16	
SH27Dx30	670	6700	88	19	
SH27Dx32	750	7500	92	20	
SH27Dx34	670	6700	90	20	
SH27Dx36			94	21	
SH27Dx41			98	22	
SH27Dx46	750	7500	100	24	
SH27Dx50			103	26	
SH32Dx27					
SH32Dx30					
SH32Dx32	850	8500	105	18	
SH32Dx34					
SH32Dx36					
SH32Dx41			110	24	
SH32Dx46					
SH32Dx50	1200	12000			
SH32Dx55			120	29	
SH32Dx60					

Inch Size Models

Commonly used in the airline industry and for specific American product installation and maintenance.

Tohnichi Head Size	Model (Body Size x Inner Width [in])	Inner Width [mm]	Allowable Torque		Outside Width C [mm]	Thickness t [mm]
			N·m [lbf·in]	mm [in]		
8D	SH8Dx1/4	6.35	2.5 [22]	15 [0.59]	3.5 [0.14]	
	SH8Dx5/16	7.94	7 [61]	20 [0.79]	4.5 [0.18]	
	SH8Dx3/8	9.53	14 [123]	25 [0.98]		
	SH8Dx7/16	11.11		27 [1.06]	5.5 [0.22]	
	SH8Dx1/2	12.7	15 [132]			
	SH8Dx9/16	14.29		29 [1.14]	6.5 [0.26]	
10D	SH10Dx1/4	6.35				
	SH10Dx5/16	7.94	20 [177]	28 [1.10]		
	SH10Dx3/8	9.53				
	SH10Dx7/16	11.11		32 [1.26]	6.5 [0.26]	
	SH10Dx1/2	12.7	25 [221]			
	SH10Dx9/16	14.29		39 [1.54]		
12D	SH12Dx3/8	9.53	12 [106]	24 [0.94]	5 [0.20]	
	SH12Dx7/16	11.11	20.5 [181]	31 [1.22]		
	SH12Dx1/2	12.7	29.5 [261]	32 [1.26]	6.5 [0.26]	
	SH12Dx9/16	14.29				
	SH12Dx5/8	15.88	59 [522]	40 [1.57]	10 [0.39]	
	SH12Dx11/16	17.46	70 [620]	41 [1.61]	11 [0.43]	
15D	SH15Dx1/2	12.7		38 [1.50]	8 [0.31]	
	SH15Dx9/16	14.29	59 [522]			
	SH15Dx5/8	15.88				
	SH15Dx11/16	17.46				
	SH15Dx3/4	19.05		51 [2.01]	13 [0.51]	
	SH15Dx13/16	20.64				
	SH15Dx7/8	22.23				
	SH15Dx15/16	23.81				
	SH15Dx1	25.40			60 [2.36]	12 [0.47]
	SH15Dx1-1/16	26.99				

Tohnichi Head Size	Model (Body Size x Inner Width [in])	Inner Width [mm]	Allowable Torque		Outside Width C [mm]	Thickness t [mm]
			N·m [lbf·in]	mm [in]		
15D	SH15Dx1-1/8	28.58				
	SH15Dx1-3/16	30.16			60 [2.36]	
	SH15Dx1-1/4	31.75				
	SH15Dx1-5/16	33.34	140 [1239]		66 [2.59]	12 [0.47]
	SH15Dx1-3/8	34.93				
19D	SH15Dx1-7/16	36.51			69 [2.72]	
	SH15Dx1-1/2	38.10				
	SH19Dx15/16	23.81				
	SH19Dx1	25.4			60 [2.36]	15 [0.59]
	SH19Dx1-1/16	26.99				
	SH19Dx1-1/8	28.58				
	SH19Dx1-3/16	30.16	200 [1947]		72 [2.83]	
	SH19Dx1-1/4	31.75				
	SH19Dx1-5/16	33.34				11 [0.43]
	SH19Dx1-3/8	34.93				
SH19Dx1-7/16	36.51			76 [2.99]		
	SH19Dx1-1/2	38.1				

The Relationship between Interchangeable Heads and Torque Wrenches

Tohnichi's interchangeable head wrenches have specific diameter round ends that fit into corresponding head base openings. Head and wrench model names include the diameter sizes so heads can be matched to wrenches that will accept those heads.

For example: SH15D×17 will fit on CL100N×15D

A variety of different head types (SH, RH, QH, RQH, FH, DH, AH and SH-N) can be used on one wrench or different types of wrenches such as CL (for tightening) and CEM3-G (for inspection) can use the same head that has the corresponding diameter size.



RH Ring Head

RoHS

The RH type ring heads guarantee the safe work as the axes of bolt and RH ring head are always aligned and prevent the heads will drop.

Note: RH8D×5.5 to RH8D×7 are single hex shape.

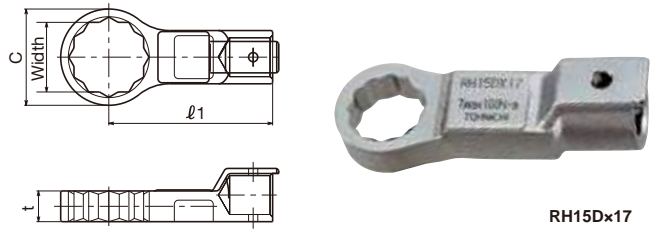

Tohnichi Head Size	Model (Body Size x Width)	Allowable Torque		Outside Width C [mm]	Thickness t [mm]	
		[N·m]	[kgf·cm]			
8D	RH8D×5.5	1.5	15	10.5	5	
	RH8D×6	2.4	24	11		
	RH8D×7	3.6	36	12	6	
	RH8D×8	7.2	72	13.5		
	RH8D×10	12.2	122	15.5		
	RH8D×11			17	7	
	RH8D×12	15	140	18		
	RH8D×13			19		
	10D	RH10D×8	7.2	72	12.5	6
		RH10D×10	12.2	122	15.5	7
RH10D×11		20	200	17	8	
RH10D×12				18		
RH10D×13				19		
RH10D×14				20		
RH10D×16				22		
RH10D×17		25	250	24		
RH10D×18				25		
RH10D×19				26		
RH10D×21			28			
RH10D×22			29			
12D	RH12D×8	7.2	72	15	5	
	RH12D×10	12.2	122	16	5.5	
	RH12D×11	20	200	18		
	RH12D×12	29.5	295	20	6.5	
	RH12D×13			21		
	RH12D×14	59	590	20	10	
	RH12D×16			24		
	RH12D×17			25	12	
	RH12D×18			26		
	RH12D×19	70	700	29	13	
RH12D×21			29			
RH12D×22			30			
RH15D×12	29.5	295	19	7		
15D	RH15D×13			22	8	
	RH15D×14	59	590	25		
	RH15D×16			25	10	
	RH15D×17			26		
	RH15D×18	100	1000	26	13	
	RH15D×19			28		
	RH15D×21			31	13	
	RH15D×22	140	1400	34		
	RH15D×24			37		
	RH15D×27			41		
RH15D×30			41			

Tohnichi Head Size	Model (Body Size x Width)	Allowable Torque		Outside Width C [mm]	Thickness t [mm]
		[N·m]	[kgf·cm]		
19D	RH19D×14	59	590	22.5	8
	RH19D×17			27	10
	RH19D×18	100	1000	28	11
	RH19D×19			29	13
	RH19D×21	166	1660	32	
	RH19D×22			35	15
	RH19D×24			39	
	RH19D×27			41	
	RH19D×30	200	2000	44	17
	RH19D×32			47	
RH19D×34			49		
RH19D×36			55		
22D	RH19D×41			55	14
	RH22D×19	166	1660	30	
	RH22D×22	255	2550	34	15
	RH22D×24			37	
	RH22D×27	490	4900	41	17
	RH22D×30			44	
	RH22D×32			45	17
	RH22D×34	500	5000	49	
	RH22D×36			51	
	RH22D×41			57	
27D	RH22D×46			62	14
	RH27D×22	255	2550	38	
	RH27D×24	350	3500	38	15
	RH27D×27	490	4900	42	16
	RH27D×30	670	6700	46	19
	RH27D×32	750	7500	48	20
	RH27D×34	670	6700	51	
	RH27D×36			52	21
	RH27D×41			58	22
	RH27D×46	750	7500	64	24
32D	RH27D×50			69	26
	RH32D×27	490	4900	43	16
	RH32D×30	670	6700	46.5	18
	RH32D×32			49	
	RH32D×34	860	8600	52	24
	RH32D×36			53	
	RH32D×41			59	29
	RH32D×46			65	
	RH32D×50	1200	12000	69	
	RH32D×55			75	
RH32D×60			80		

Inch Size Models

Commonly used in the airline industry and for specific American product installation and maintenance.

Tohnichi Head Size	Model (Body Size x Inner Width [in])	Inner Width [mm]	Allowable Torque N·m [lbf·in]	Outside Width C [mm [in]]	Thickness t [mm [in]]
8D	RH8D×1/4	6.35	3.6 [31]	11 [0.43]	5 [0.20]
	RH8D×5/16	7.94	7.2 [63]	13.5 [0.53]	6 [0.24]
	RH8D×3/8	9.53	12.2 [108]	15 [0.59]	7 [0.28]
	RH8D×7/16	11.11	15 [132]	17 [0.67]	
10D	RH10D×1/4	6.35		11 [0.43]	6 [0.24]
	RH10D×5/16	7.94	7.2 [64]	12.5 [0.49]	
	RH10D×3/8	9.53	12.2 [108]	15.5 [0.61]	7 [0.28]
	RH10D×7/16	11.11		17 [0.67]	8 [0.31]
	RH10D×1/2	12.7	25 [221]	19 [0.75]	
	RH10D×9/16	14.29		20 [0.79]	
RH12D×3/8	9.53	12.2 [108]	16 [0.63]	5 [0.20]	
12D	RH12D×7/16	11.11	20 [177]	18 [0.71]	5.5 [0.22]
	RH12D×1/2	12.7	29.5 [261]	21 [0.83]	6.5 [0.26]
	RH12D×9/16	14.29		20 [0.79]	10 [0.39]
RH12D×5/8	15.88	59 [522]	24 [0.94]		

Tohnichi Head Size	Model (Body Size x Inner Width [in])	Inner Width [mm]	Allowable Torque N·m [lbf·in]	Outside Width C [mm [in]]	Thickness t [mm [in]]
15D	RH15D×1/2	12.7	29.5 [261]	19 [0.81]	7 [0.28]
	RH15D×9/16	14.29		22 [0.87]	8 [0.31]
	RH15D×5/8	15.88	59 [522]	25 [0.98]	
	RH15D×11/16	17.46	100 [885]	26 [1.06]	10 [0.39]
	RH15D×3/4	19.05	140 [1239]	28 [1.10]	13 [0.51]

Accessories



The Relationship between Interchangeable Heads and Torque Wrenches

Tohnichi's interchangeable head wrenches have specific diameter round ends that fit into corresponding head base openings. Head and wrench model names include the diameter sizes so heads can be matched to wrenches that will accept those heads.

For example: SH15D×17 will fit on CL100N×15D

A variety of different head types (SH, RH, QH, RQH, FH, DH, AH and SH-N) can be used on one wrench or different types of wrenches such as CL (for tightening) and CEM3-G (for inspection) can use the same head that has the corresponding diameter size.

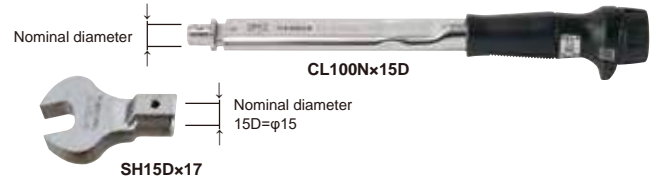

QH Ratchet Head **RoHS**

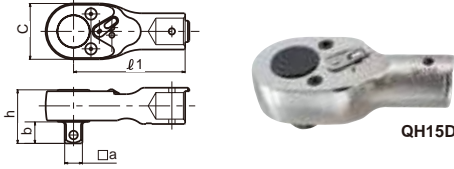

As the QH type ratchet heads need only small swing for tightening, they suit for operations in narrow spaces.

Head Size	Model	Dimensions			
		Sq. Drive a [mm]	Outside Width c [mm]	h [mm]	b [mm]
8D	QH8D	6.35	23	17.5	7.5
10D	QH10D-1/4		26	18.5	
	QH10D		22		
12D	QH12D	9.53	32	25.6	11
15D	QH15D-3/8		37.5	30.5	
	QH15D			33.5	14
19D	QH19D	12.7	40	38.4	15.4
22D	QH22D-1/2		51	41.5	15.5
	QH22D			46.5	20.5
27D	QH27D	19.05	70	49.7	21.5
32D	QH32D	25.4	74	55.7	26.5

- Note**
- For the model having 25.4mm square drive, use a through-hole socket. QH15D-3/8 Tmax 100N·m
QH22D-1/2 Tmax 280N·m
 - Ratchet protective cover is available. Refer to page 49.

DH Square Drive Head **RoHS**

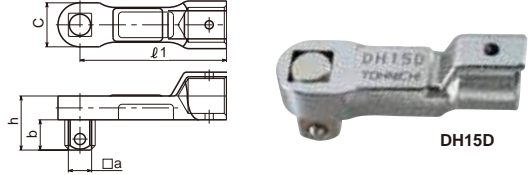

The DH square drive heads are the standard interchangeable head. They are useful when tightening a large number of matching screws with a common torque wrench. It is recommended to keep one set. They are used with sockets.

Head Size	Model	Dimensions			
		Sq. Drive a [mm]	Outside Width c [mm]	h [mm]	b [mm]
10D	DH10D	9.53	18	22.5	13
12D	DH12D		22	23	
15D	DH15D		22		
19D	DH19D	12.7	24	29.5	16.5
22D	DH22D		34	43.3	
27D	DH27D	19.05	42	44.5	23.5
32D	DH32D	25.4	50	58.5	30.25

Note DH32D is a through hole type.

RQH Female Ratchet Head **RoHS**

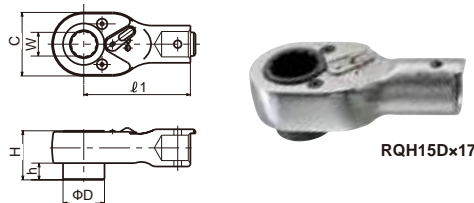

As the RQH type ratchet heads need only small swing for tightening, they suit for operations in narrow and low ceiling spaces.

Head Size	Model (Body Size × Width)	Dimensions			
		D [mm]	Outside Width C [mm]	H [mm]	h [mm]
12D	RQH12D×12	20.5	32	24.1	
	RQH12D×14				
15D	RQH15D×14	24.5	37.5	29	
	RQH15D×17				
19D	RQH19D×17				10
19D	RQH19D×19	31	45	28	
	RQH19D×22				
22D	RQH22D×22	35.2	51	35	
	RQH22D×24				

Ratchet Protective Cover for QH/RQH

Fit on your Tohnichi Ratchet Head to protect your work



Part #	Applicable Interchangeable Head
870	QH8D
871	QH10D
872	QH12D/RQH12D
874	QH15D/RQH15D
875	QH19D
876	RQH19D
878	QH22D/RQH22D

HH Hex Head **RoHS**

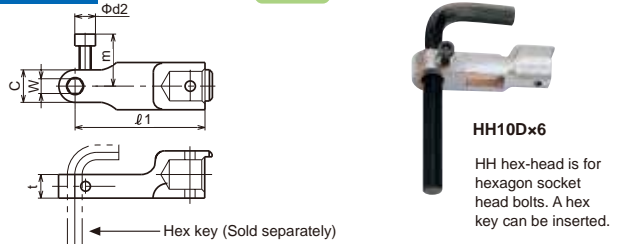

The HH hex-head is for hex. socket head cap screws.

Head Size	Model (Body Size × Width)	Dimensions			
		Outside Width C [mm]	t [mm]	m [mm]	φd2 b [mm]
8D	HH8D	12	14.5	-	-
	HH10D×5	11			
10D	HH10D×6	12	8		
	HH10D×8	15			
12D	HH12D×5	11		19	7
	HH12D×6	14	10		
	HH12D×8	15			
15D	HH12D×10	17			
	HH15D×8	14			
	HH15D×10	17		21	
15D	HH15D×12	20			
	HH15D×14	21.5			
	HH19D×10	17	13		8.5
19D	HH19D×12	21.5			
	HH19D×14	23		23	
	HH19D×17	27			
19D	HH19D×19	29			
	HH22D×12	19.5			
	HH22D×14	27			
22D	HH22D×17	30	17	26	10
	HH22D×19	32			
	HH22D×22	35			

- Note**
- To be used with hex. key inserted.
 - HH8D is not used with hex. key but interchangeable bit.
 - Insertion of HH10D×5 and HH10D×6 are hexagon. Others are double hexagon.



Bits are sold separately. Refer to page 10.

AH/AH2 Adjustable Open End Head RoHS

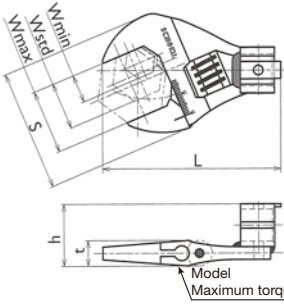

AH15D2x30

AH is easy and convenient to use for applications that require different size bolt heads. Available currently only for the 15mm diameter root shaped Tohnichi torque wrenches.

Head Size	Model (Body Size x Width)	Allowable Torque		Inner Width Min.-Standard- Max.[mm]	Dimensions			
		[N·m]	[kgf·cm]		S [mm]	L [mm]	t [mm]	h [mm]
10D	AH10Dx13	25	250	3-8-13	36	57	9	23
	AH10Dx26			7-17-26	49	62	11	25
12D	AH12Dx13	30	300	3-8-13	36	66	9	23
	AH12Dx26			7-17-26	49	71	11	26
15D	AH12Dx36	50	500	8-22-36	65	78	13	27
	AH15D2x26			10-18-26	50	77	11	31
	AH15D2x30	100	1000	13-22-30	60	84	12	32
	AH15D2x36	140	1400	13-24-36	65	87	13	33

Note Use with a click type torque wrench.

SH-N Open End Head with Notch RoHS

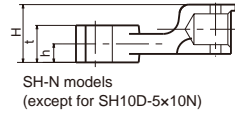
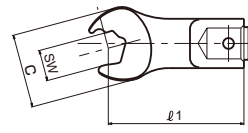

SH-N models (except for SH10D-5x10N)

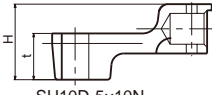

SH10D-5x10N



SH10D-1x10N

The notch creates speed in the tightening process by grasping the side of the fastener without removing the wrench. Ideal for brake line assembly.

Head Size	Model (Body Size x Width)	Allowable Torque		Dimensions			
		[N·m]	[kgf·cm]	Outside Width C [mm]	Thickness		
				H [mm]	t [mm]	h [mm]	
10D	SH10D-1x10N			18.75	12	6	
	SH10D-3x10N	22.5	225	20.25	15	7.5	
	SH10D-5x10N	19	190	24.5	15	-	
	SH10D-4x10N			17.75	10	5	
	SH10D-9x10N	22.5	225	18.75	10	6	
12D	SH10Dx11N			18.8	12	6	
	SH10Dx12N	25	250	32	16	6.5	3.25
	SH12Dx11N			30	19	7.5	-
	SH12D-1x12N			21	12	6	
	SH12D-3x12N	30	300	22.5	15	7.5	
	SH12D-5x12N			26	15	-	
	SH12D-4x12N			20	10	5	
	SH12D-1x14N			21	12	6	
	SH12D-3x14N	40	400	22.5	15	7.5	
	SH12D-5x14N			26	15	-	
15D	SH12D-4x14N			20	10	5	
	SH12D-1x17N			21	12	6	
	SH12D-3x17N	50	500	22.5	15	7.5	
	SH12D-5x17N			26	15	-	
	SH12D-4x17N			20	10	5	

PH Pipe Wrench Head RoHS



PH15Dx350

The PH heads suit for use with pipes and plumbing applications.

Head Size	Model (Body Size x Width)	Pipe Wrench Head Max. Length [mm]	Applicable Pipe Diameter [mm]	Standard Pipe Diameter [mm]	Recommendable Torque Wrench
15D	PH15Dx350				
19D	PH19Dx350	350	13-38	25.5	CSP
22D	PH22Dx350				
	PH22Dx450	450	26-52	39	

Note 1. PH can be used with CSP model (P.18) only.
2. When ordering with CSP, please specify PH model name and required set torque.
3. In case of using graduated torque wrench, order PHL models.

FH Hook Head RoHS

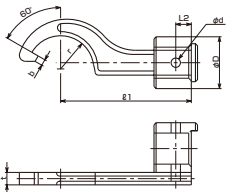

FH

The FH hook heads are ideal for use with bearing locknut applications.

Head Size	Model (Body Size x Width)	Applicable Size of Nut Outside Diameter [mm]	Nominal Size of Screw	Dimensions								
				r [mm]	O [mm]	b [mm]	t [mm]	H [mm]	D [mm]	L2 [mm]	d [mm]	
15D	FH15Dx30	30-38	M20	16								
	FH15Dx38	38-45	M25	20		3	6	30				
	FH15Dx45	45-52	M30	24						25	7.5	4.5
	FH15Dx52	52-58	M35	27	60	3.5	7	30.5				
19D	FH15Dx58	58-65	M40	31		4.5		31				
	FH19Dx65	65-75	M45, M50	35.5			8	35.5	29	9.5		
22D	FH22Dx75	75-85	M60, M65	39				38.5				
	FH22Dx85	85-98	M70, M75	45.5	45	5	10	40	32	11	5.5	

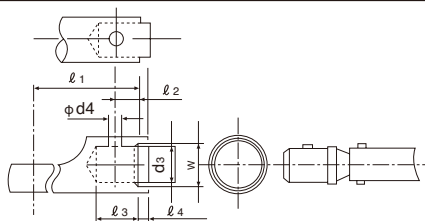

CPQH Corrosion-Resistant Ratchet Head

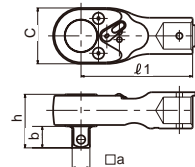

CPQH12D

QH type ratchet head with anticorrosion coating is ideal for wet conditions and features ratcheting action for narrow spaces.

Head Size	Model	Dimensions			
		Sq. Drive a [mm]	Outside Width c [mm]	h [mm]	b [mm]
10D	CPQH10D		26	22	
12D	CPQH12D	9.53	32	25.6	11
15D	CPQH15D		37.5	33.5	14
19D	CPQH19D	12.7	40	38.4	15.4

Common Dimensions for Interchangeable Head

Model	Dimensions [mm]						
	l1	l2	l3	l4	d3	d4	W
SH8D, RH, QH, HH	35	4	10	2	8	3.0	9
SH10D, RH, QH, HH, DH, SH-N	44	5	12	2.5	10	3.5	12
SH12D, RH, QH, HH, DH, RQH	53	6	14	3	12	3.5	14
SH15D, RH, QH, HH, DH, RQH, FH	63	7.5	17	3	15	4.5	17
SH19D, RH, QH, HH, DH, RQH, FH	80	9.5	21	3	19	4.5	21
SH22D, RH, QH, HH, DH, RQH, FH	100	11	24	3.5	22	5.5	24
SH27D, RH, QH, DH	125	13.5	29	5	27	6.5	30
SH32D, RH, QH, DH	160	16	34	7	32	6.5	35

Note When requesting a special head that is used with various types of torque wrench, it is strictly required to follow the "l1" dimension to keep torque accuracy. Any deviation from the "l1" dimension affects torque accuracy.



Auxiliary Equipment

To facilitate effective and convenient use of Tohnichi products, a number of auxiliary parts and special tools are available (Some torque tools are provided with the necessary auxiliary parts). We are ready to manufacture custom-made parts and tools to meet your requirements.

For Torque Wrench

QH/QL/PQL/QSP PROTECTIVE HEAD COVER

Fit on your Tohnichi Ratchet Head to protect your work



Part #	Applicable Interchangeable Head & Model	
870	QH8D	QL-PQL2N-15N/-MH, QSP1.5N4-12N4
871	QH10D	QL-PQL-QSP25N/-MH
872	QH12D/RQH12D	QL-PQL-QSP50N/-MH
873	-	QL-PQL-QSP100N4/-MH
874	QH15D/RQH15D	QL-PQL-QSP140N/-MH
875	QH19D	QL-PQL-QSP200N4/-MH
876	RQH19D	-
877	-	QL-PQL-QSP280N4/-MH
878	QH22D/RQH22D	QL-PQL-QSP420N

TIQLE ADJUSTING TOOL FOR TIQLE

For previous large QLE and current TIQLE models



Part #	Applicable Model
301	TIEQLE750N-TIEQLE1400N

SP THRUSTRING TOOL FOR SP

This tool is used to set the torque of preset types SP, RSP, QSP and CSP torque wrenches.



Part #	Tool #	Applicable Model
310	A-1	QSP/CSP1.5N-6N
311	A-2	SP2N-SP19N, QSP/CSP12N, QSP/CSP25N
312	A-3	SP38N, SP67N, QSP/CSP50N-140N
313	A-4	SP120N-SP310N, QSP200N-QSP280N
314	A-5	QSP/CSP420N, BQSP/BCSP400N
315	A-6	SP420N, SP560N

QSP3 ADJUSTING TOOLS FOR QSP3



Part #	Dimensions [mm]	Applicable Model
931	2.5 x 1.5 x 6	QSP/CSP25N3, QSP1.5N4-12N4 SP2N2-19N2, SP19N2-N BQSP/BCSP10N-20N CSP1.5N4-CSP12N4 QSPCA6N, 12N
930	4 x 2.5 x 8	QSP/CSP50N3-QSP/CSP280N3 SP38N2-N, SP/RSP38N2-310N2 BQSP/BCSP40N-300N MQSP50N-200N, MCSP50N-140N QSPCA30N-70N

DB TOOL SET FOR DB

This set of pliers is used to adjust the torque for dial type torque wrenches and torque checkers.



Part #	Applicable Model
316	DB, DBE, CDB-S, T-S, DOT

CARRYING CASE



842



846

Part #	Dimensions [mm]	Weight [kg]
842	QL50N/-MH, MTQL40N/70N, QL100N4/-MH, CL50Nx12D/-MH, CL50Nx15D/-MH, CL100Nx15D/-MH H60 x W400 x D70	0.25
843	QL140N/-MH, MTQL140N, QL200N4/-MH, CL140Nx15D/-MH, CL200Nx19D/-MH H60 x W520 x D80	0.36
846	QL140N/-MH and below, MTQL and below, CL200Nx19D/-MH and below H170 x W500 x D100	1.0
847	QL280N/-MH and below, CL280Nx22D/-MH and below H170 x W740 x D100	1.6

For Torque Screwdriver

LTD, RTD ADJUSTING TOOL FOR LTD/RTD

This tool is used to adjust the torque of LTD and RTD torque screwdrivers.



Part #	Applicable Model
51	LTD/RTD15CN, LTD/RTD30CN
46	LTD/RTD60CN
47	LTD/RTD260CN
48	LTD/RTD500CN
49	LTD/RTD1000CN
1046	LTD/RTD120CN
1050	LTD2000CN2

LTD TIGHTENING TOOL FOR LTD

This tool makes tightening with large LTD much easier.



Part #	Applicable Model
31	LTD/RTD/NTD/RNTD500CN FTD400CN
32	LTD/NTD1000CN FTD8N, FTD16N
40	LTD2000CN, LTD2000CN2

LTD/RTD/MNTD HOOK SPANNER

This tool makes it easier to set the torque for mid. to large capacity torque screwdrivers.



Part #	Applicable Model
52	LTD/RTD260CN, MNTD120CN
53	LTD/RTD500CN, MNTD260CN
54	LTD1000CN, MNTD500CN
55	LTD2000CN, LTD2000CN2

NTD/RNTD ADJUSTING BAR FOR NTD/RNTD

This tool is used to set the torque of preset types NTD and RNTD screwdrivers.



Part #	Applicable Model
42	NTD/RNTD15CN-120CN
43	NTD/RNTD260CN, RNTDZ260CN
44	NTD/RNTD500CN-1000CN, RNTDZ500CN

TORQUE SCREWDRIVER ADAPTER

This accessory is used with TME2 and TM torque meters to check UNITORK and torque screwdrivers.



Part #	Applicable Model
30	LTD/RTD/NTD/RNTD FTD50CN-FTD400CN

Lubricant for repairing torque products EVERTORQUE

Model	Part #
EVERTORQUE	830



RoHS





Applicable Models and Parts

	Applicable Model	Applicable Part
Click Type Torque Wrench	QL, QLE2, CL, CLE2, PQL, PCL, YCL etc.	Thrusting; Steel Ball Scale Piece, Adjusting Screw; Thread
	WQL	Thrusting; Steel Ball Scale Piece, Adjusting Screw; Thread Screw Knob, Protector; Joint
Click Type Torque Screwdriver	MPQL	Thrusting; Steel Ball Scale Piece, Adjusting Screw; Thread Ratchet, Marker Pipe; Joint
	RTD, RNTD RTD, LTD, BMLD	Main Shaft, Toggle Sheet; Serration Case, Adjusting Piece; Thread

Connecting Cable

* The cable length is 2m.

■ EPP16M3 Printer Connecting Cable



Part #	Applicable Model	Figure		Plug
383	DOT4-G (P.55), TDT3-G (P.57), LC3-G (P.58), TME2 (P.61), CD5 (P.69)			D-SUB 9 Pin Female
575	CTA2-G (P.23), CEM3-G/CEM3-P (P.35), CTB2-G (P.36), R-DT999 (P.69),			D-SUB 9 Pin Female

■ PC Connecting Cable



Part #	Applicable Model	Figure		Plug
575	CTA2-G (P.23), CEM3-G/CEM3-P (P.39), CTB2-G (P.40), R-DT999 (P.69),			D-SUB 9 Pin Female
584	CTA2-G (P.23), CEM3-G/CEM3-P (P.39), CTB2-G (P.40), R-DT999 (P.69),			USB A type
585	CPT-G (P.22)			D-SUB 9 Pin Female
383	DOT4-G (P.55), TDT3-G (P.57), LC3-G (P.58), TME2 (P.61), CD5 (P.69)			D-SUB 9 Pin Female
384	STC2-G (P.9), ST3-G (P.58), ATGE-G (P.59), BTGE-G (P.60)			USB A type
385	DOT4-G (P.55), TDT3-G (P.57), LC3-G (P.58)			USB A type
387	R-CM(P29), SB-FH2(P.29)			RS232C Straight Female-Female

Quick Charger, Battery Pack, AC Adapter



■ Quick Charger



Model	Applicable Model	Figure
RoHS BC-3-G	CEM3-G/CEM3-P (P.39), CTA2-G (P.23) CTB2-G (P.40) (100-240V)	
RoHS BC-4-2	ST3-G (P.58)	

■ Battery Pack

Model	Applicable Model	Figure
RoHS BP-5	CTA2-G (P.23), CEM3-G/CEM3-P (P.39), CTB2-G (P.40)	
RoHS BP-7	STC2-G (P.9)	

■ AC Adapter

Model	Applicable Model	Figure
RoHS BA-6	DOT4-G (P.55), TDT3-G (P.57), LC3-G (P.58), CD5 (P.67)	
RoHS BA-7	STC2-G (P.9), ATGE-G (P.59), BTGE-G (P.60)	
RoHS BA-8W	TPC/TPC2 (P.68)	

Model	Applicable Model	Figure
RoHS BA-4	TME2 (P.61)	
RoHS BA-8R	R-CM (P.29), R-FMA (P.32), R-BT (P.52)	



A3/AC3

Semi-Automatic
Airtork

Direction RoHS



A50N3 Low provisional type



AC50N3 High provisional type

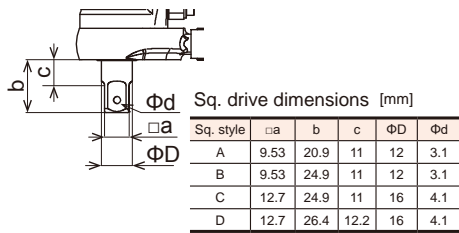

ACLS50N3 High provisional with limit switch type

Assembly Angle Pneumatic Graduation Push button ISO6789:2017

- High speed and high precision bolt tightening by an integrated air motor and torque wrench
- New square drive head accommodates anti-vibration sockets
- A3: Low provisional torque type, AC3: High provisional torque type

S.I. Model	Torque Range [N·m]		Metric Model	Torque Range [kgf·cm]		American Model	Torque Range [lbf·in/lbf·ft]		Provisional Tightening Torque [N·m]	Free Speed [r.p.m]	Air Pressure [MPa]	Hose Dia. [mm]	Overall Length [mm]	Sq. Drive [mm]	Sq. Style	Weight [kg]
	Min.-Max.	Grad.		Min.-Max.	Grad.		Min.-Max.	Grad.								
A10N3	3-10	0.1	A100M3	30-100	1	A90I3-3/8	30-90	1								
A25N3	5-25	0.25	A250M3	50-250	2.5	A200I3-3/8	50-200	2.5	1.8	750		φ5	277		A	1.0
A50N3	10-50	0.5	A500M3	100-500	5	A400I3-3/8	100-400	5								
-	-	-	-	-	-	A800I3-3/8	200-800	10								
-	-	-	-	-	-	A75F3-3/8	15-75	1	2.5	800		φ6	338		B	1.4
A100N3	20-100	1	A1000M3	200-1000	10	-	-	-			0.6				C	
A180N3	40-180	2	A1800M3	400-1800	20	A130F3-1/2	30-130	2	5				487		D	2.6
AC25N3	5-25	0.25	AC250M3	50-250	2.5	AC200I3-3/8	50-200	2.5								
AC50N3	10-50	0.5	AC500M3	100-500	5	AC400I3-3/8	100-400	5	11	1000		φ5	293		A	1.5
-	-	-	-	-	-	AC800I3-3/8	200-800	10								
-	-	-	-	-	-	AC75F3-3/8	15-75	1	17.5	900		φ6	334		B	2.0
AC100N3	20-100	1	AC1000M3	200-1000	10	-	-	-							C	
AC180N3	40-180	2	AC1800M3	400-1800	20	AC130F3-1/2	30-130	2	19	800			489		D	3.3

Note 1. Provisional tightening torque is not warranty the accuracy.
2. Use pneumatic sockets only.
3. Through hole type square drive.

A3LS/AC3LS

- A3/AC3 style with limit switch output
- Wired Error-Proofing, Pokayoke, system for assembly processes

S.I. Model	Torque Range [N·m]		Metric Model	Torque Range [kgf·cm]		American Model	Torque Range [lbf·in/lbf·ft]		Provisional Tightening Torque [N·m]	Free Speed [r.p.m]	Overall Length [mm]	Square Drive [mm]	Weight [kg]		
	Min.-Max.	Grad.		Min.-Max.	Grad.		Min.-Max.	Grad.							
ALS10N3	3-10	0.1	ALS100M3	30-100	1	ALS90I-3/8	30-90	1							
ALS25N3	5-25	0.25	ALS250M3	50-225	2.5	ALS200I3-3/8	50-200	2.5	1.8	750		277		1.2	
ALS50N3	10-50	0.5	ALS500M3	100-500	5	ALS400I3-3/8	100-400	5							
ACLS25N3	5-25	0.25	ACLS250M3	50-250	2.5	ACLS200I3-3/8	50-200	2.5							
ACLS50N3	10-50	0.5	ACLS500M3	100-500	5	ACLS400I3-3/8	100-400	5	11	1000		293		9.5	1.5
-	-	-	-	-	-	ACLS800I3-3/8	200-800	10							
-	-	-	-	-	-	ACLS75F3-3/8	15-75	1	17.5	900		334			2.2
ACLS100N3	20-100	1	ACLS1000M3	200-1000	10	-	-	-							
ACLS180N3	40-180	2	ACLS1800M3	400-1800	20	ACLS130F3-1/2	30-130	2	19	800		488		12.7	3.5

Assembly Pistol Pneumatic Graduation Trigger

- High speed and high accuracy tightening
- Easy torque adjustment by scale with key

S.I. Model	Torque Range [N·m]		Metric Model	Torque Range [kgf·cm]		American Model	Torque Range [lbf·in]		Free Speed [r.p.m]	Air Pressure [MPa]	Hose in Dia. [mm]	Standard Accessory Bit ⊕	Weight [kg]
	Min.-Max.	Grad.		Min.-Max.	Grad.		Min.-Max.	Grad.					
AUR5N	2-5	0.1	AU50R	20-50	1	AU50R-A	15-45	1	2100			#3	1.5
AUR12.5N	5-12.5	0.25	AU125R	50-125	2.5	AU125R-A	37.5-112.5	2.5	800	0.5	φ10	-	1.7
AUR25N	10-25	0.5	AU250R	100-250	5	AU250R-A	75-225	5	400			-	

Note 1. AUR5N has #3 bit, 6.35 HEX, with a double bit. Any other bits are available in the local market.
2. AUR12.5N and AUR25N have a fixed 9.53mm square drive. Use pneumatic sockets only.

Standard Accessories 1. Torque adjusting key
2. Supportive Handle for AUR25N/AURLS25N
3. W12 Open ended spanner for AUR25N/AURLS25N
4. Counter clockwise rotation has no torque control and it is loosening purpose only.

AURLS

- AUR style with limit switch output
- Wired Error-Proofing, Pokayoke, system for assembly processes

S.I. Model	Torque Range [N·m]		Metric Model	Torque Range [kgf·cm]		American Model	Torque Range [lbf·in]		Free Speed [r.p.m]	Air Pressure [MPa]	Hose in Dia. [mm]	Standard Accessory Bit ⊕	Weight [kg]
	Min.-Max.	Grad.		Min.-Max.	Grad.		Min.-Max.	Grad.					
AURLS5N	2-5	0.1	AU50RLS	20-50	1	AU50RLS-A	15-45	1	2100			#3	1.5
AURLS12.5N	5-12.5	0.25	AU125RSL	50-125	2.5	AU125RSL-A	37.5-112.5	2.5	800	0.5	φ10	-	1.7
AURLS25N	10-25	0.5	AU250RSL	100-250	5	AU250RSL-A	75-225	5	400			-	

POKA Patrol, Count Checker
CNA-4mk3

Refer to page 27.

* Sold Separately

AUR

UNITORK/Pistol Type
Pneumatic Torque
Screwdriver

Direction RoHS



AUR12.5N

HAC

Battery Operated Semi-Automatic Torque Wrench

Direction **RoHS**



HAC50N

Battery Reference

For battery and charger, Hitachi Koki UC18 series are available commercially.

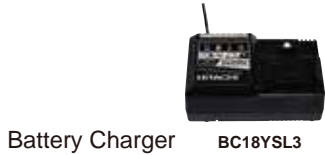

Battery Charger **BC18YSL3**



Battery **BP1830C** **BP1860**

- Note**
1. Guideline tightening No. is 1500 operations for BP1830C and 3000 operation for BP1860.
 2. The guideline is in case of middle joint. It is subject to change due to joint coefficient.

* Bluetooth is a registered trademark of Bluetooth SIG, Inc.

Assembly **Electric** **Re-Chargeable** **Graduation** **Trigger** **ISO6789:2017**

- More reasonable and accurate than electric hand nutrunner
- Provisional tightening by electric motor and final tightening by hand. Two in one function.
- Pokayoke function is equipped as standard.
- Capable of calibrating by torque wrench tester

Accuracy ±3%

S.I. Model	Torque Range [N·m]		Max. Provisional Tightening torque	Free Speed [r.p.m.]	Overall Length [mm]	Square Drive [mm]	Weight [kg]
	Min.-Max.	Grad.					
HA25N	5-25	0.25	4	1000	406	9.53	1.5
HAC25N							
HAC50N	10-50	0.5	11	1100	445		1.9
HAC100N	20-100				491		2.4
HAC140N	30-140	1	17.5	1000	557	12.7	2.8
HAC200N	40-200	2	30	580	670		3.6

- Note**
1. Provisional torque is easily changed in 3 levels.
 2. Battery charger, Battery, Balancer, Receiver/R-BT, and Adapter/BA-8 are optional.
 3. Contact to Tohnichi for condition of wireless equipment in each country.

Standard Accessories Hex bit W=4/Adjusting tool



HAC with balancer



R-BT

Bluetooth® Receiver

Model	Version
R-BT	V3.0

- Note**
1. It is receivable up to 4 pcs of HAC.
 2. Supplied with DC24V input terminal
 3. Communication distance is 10m.

R-BT AC Adapter

Model
BA-8R

Note AC100-240V is applicable.



BA-8R

HAT

HANDYTORK/ Battery Operated Torque Screwdriver

Direction



HAT25N

HAT Optional Accessories



Battery **BP-12**

Model	Description
BP-12	DC 12V



Battery Charger **BC-1**

Part #	Model
820	BC-1 (AC100V)

Assembly **Pistol** **Re-Chargeable** **Graduation** **Trigger**

- Easy calibration check with standard torque wrench tester
- Available with reverse and as FH version

Accuracy ±5%

S.I. Model	Torque Range [N·m]		Free Speed [r.p.m.]	Voltage DC [V]	Square Drive [mm]	Weight [kg]
	Min.-Max.	Grad.				
HAT25N	10-25	0.5	700	12	9.5	1.8
HATR25N			140			

- Note**
1. Torque accuracy is based upon static torque measured by torque wrench tester.
 2. HATR/HATRFH has a reverse mode function.
 3. HATFH/HATRFH is error-proofing (Pokayoke) type, and it can be used only with R-CM receiver with M-FH radio module (sold separately) as count verification system.
 4. Use pneumatic sockets only.
 5. HAT battery and battery charger are optional.
 6. It is designed for 100V usage only.

Standard Accessories

1. W4 hex key
2. Supportive handle for HAT25N, HATR25N, HATFH25N, HATRFH25N

HATFH

- Wireless error-proofing, Pokayoke, system for HAT
- Tightening completion signal output to eliminate missed tightening

Accuracy ±5%

S.I. Model	Torque Range [N·m]		Free Speed [r.p.m.]	Voltage DC [V]	Square Drive [mm]	Weight [kg]
	Min.-Max.	Grad.				
HATFH25N	10-25	0.5	700	12	9.5	1.8
HATRFH25N			140			

Receiver R-CM

Refer to page 28 for wireless Pokayoke system configuration.

*Sold separately



POKA Patrol, Count Checker CNA-4mk3

Refer to page 27.

* Sold Separately



PTA-G-BTA

NEW

Assembly Electric Pistol Trigger Bluetooth®

RoHS

Direction Fully-Automatic Electric Torque Screwdriver



PTA10N-G-BT with optional battery



PTA-G-BT Setting software

* Bluetooth is a registered trademark of Bluetooth SIG, Inc.

- Torque & angle monitoring function provides double tightening prevention
- No controller necessary, data transmission by Bluetooth® communication
- Torque checking with a standard torque wrench tester.

Torque Accuracy ±5%, Angle Accuracy ±5%

Model	Torque Range [N·m]		Torque Range [kgf·cm]		Torque Range [lbf·in]		Free Rotation Speed [r.p.m]		Overall Length	Overall Height	Weight
	Min.-Max.	Grad.	Min.-Max.	Grad.	Min.-Max.	Grad.	Standard joint	Hard joint	[mm]	[kg]	
PTA5N-G-BTA	2-5	0.01	20-50	0.1	20-45	0.1	1000	500	240	229	1.0 (1.7)
PTA510N-G-BTA	4-10	0.02	40-100	0.2	40-90	0.2	500	450	259	(297)	1.1 (1.8)

- Note**
1. The value with in () includes a battery pack.
 2. Counterclockwise rotation has no torque control. It is loosening purpose only.
 3. Battery and battery charger are not included. Purchase them at local store.
 4. Contact Tohnichi for status of wireless certification acquisition for each country.

Bluetooth® Receiver

Model	Version
R-BT	V3.0

- Note**
1. It is available up to 4 pcs of PTA-G-BT at relay output mode, or one by one at data transfer mode
 2. Supplied with DC24V input terminal
 3. Communication distance is 10m.



R-BT

Battery & Battery Charger

Model	Version
EYFB50B	Panasonic, 18V battery
EY0L82B	Panasonic, 120V, 220-240V

- Note**
1. Battery pack and Battery charger will not provided from Tohnichi, purchase them from local supplier.
 2. Approximate 3500 spindle of tightening by a battery pack



EYFB50B



EY0L82B

U/UR

UNITORK/Straight & Pistol Type Pneumatic Torque Screwdriver

Direction

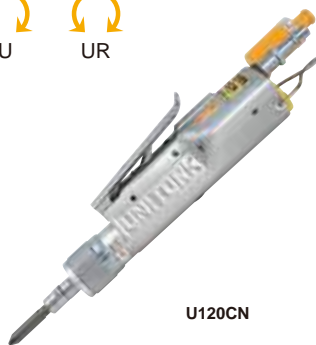

U120CN

Assembly Straight/Pistol Pneumatic Graduation Trigger/Lever

RoHS

- Accurate and stable tightening for small size screws
- Lever activated

Accuracy ±5%

S.I. Model	Torque Range [cN·m]		Metric Model	Torque Range [kgf·cm]		American Model	Torque Range [lbf·in]		Free Speed [r.p.m]	Air Pressure [MPa]	Hose in Dia. [mm]	Weight [kg]	Standard Accessory Bit
	Min.-Max.	Grad.		Min.-Max.	Grad.		Min.-Max.	Grad.					
U30CN	cN-m 10-30	0.5	U3	kgf-cm 1-3	0.05	U3-A	lbf-in 1-3	0.05	1600	0.4		0.32	#0
U60CN	20-60	1	U6	2-6	0.1	U6-A	2-5	0.1	1700	0.5	φ5	0.42	#1
U120CN	40-120	2	U12	4-12	0.2	U12-A	4-10	0.2	1400			0.48	
U250CN	100-250	5	U25	10-25	0.5	U25-A	8-22	0.5	1200	0.6		0.75	#2
U500CN	200-500	10	U50-2	20-50	1.0	U50-2-A	15-45	1.0	950	0.5	φ6	1.35	#3
U1000CN	400-1000		U100	40-100		U100-A	30-90		700			2.0	
ULR120CN	40-120	2	U12LR	4-12	0.2	U12LR-A	4-10	0.2	1300	0.5	φ5	0.56	#2
ULR250CN	100-250	5	U25LR	10-25	0.5	U25LR-A	8-22	0.5	1000	0.6	φ6	0.95	#3
UR500CN	200-500	10	U50R	20-50	1.0	U50R-A	15-45	1.0	950			1.45	

- Note**
1. U1000CN has a fixed square drive (9.53mm). Use socket bits or bit holders for this model.
 2. UR has revers function, the counterclockwise rotation has no torque control, it is loosening purpose only.
 3. U500CN, U1000CN, and UR500CN are pistol type with trigger mechanism.
 4. U30CN is required Tohnichi dedicated bit, others are available a local market one.

- Standard Accessories**
1. One touch coupler for U30CN-U250CN, ULR120CN, and ULR250CN.
 2. Bit holder for U1000CN

U/UR Optional Accessories

One Touch Joint (Female)

Part #	Applicable Model	Size
133	U30CN-U250CN	PF 1/4 Female
134		PF 1/4 Male
135		φ8 Hose Joint

- Note**
- # 133, # 134, # 135 one-touch joints cannot be attached to U / URs purchased before March 2020. Please consult with Tohnichi or the store where you purchased the product.

Tool Kit for disassembly/assembly for UNITORK

Part #	Applicable Model
162	U500CN, UR500CN
163	U1000CN

MG/MF

Multiple Unit/ Pneumatic Straight Style

Direction



MF12N

Automatic Straight Pneumatic Graduation Master Valve Operation

RoHS

- Several units used simultaneously with loader
- Fully automatic tightening for complex bolt configurations

Accuracy ±5%

S.I. Model	Torque Range [cN·m/N·m]		Metric Model	Torque Range [kgf·cm]		American Model	Torque Range [lbf·in]		Free Speed [r.p.m]	Air Pressure [MPa]	Hose Dia. [mm]	Overall Length [mm]	Bit Holder [mm]	Weight [kg]
	Min.-Max.	Grad.		Min.-Max.	Grad.		Min.-Max.	Grad.						
MG120CN	cN-m 40-120	1	M12G	kgf-cm 4-12	0.1	M12G-A	lbf-in 4-10	0.2	720	0.4	φ5	287-279	6.35 Hex	0.68
MG250CN	100-250	2.5	M25G	10-25	0.25	M25G-A	8-22	0.5	350					
MF6N	N-m 3-6	0.1	M60F	30-60	1	M60F-A	25-50	1	1000	0.6	φ6	411-403	2.0	
MF12N	6-12	0.2	M120F	60-120	2	M120F-A	50-100	2	500					

- Note**
1. MG/MF is 6.35 HEX bit holder type.
 2. For designing a multi-spindle system, check the PCD, minimum distance between the spindles.
 3. For first-time user, consult Tohnichi for assistance.

- Standard Accessories**
- Torque adjusting key

AP2

Fully-Automatic Airtork

Assembly

Pistol

Pneumatic

Graduation

Trigger

RoHS

Direction

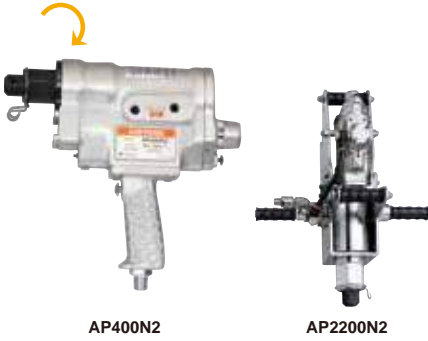

AP400N2

AP2200N2

- For large bolt tightening
- Automatic shut off at final torque set

Accuracy ±5%

S.I. Model	Torque Range [N·m]		Metric Model	Torque Range [kgf·m]		American Model	Torque Range [lbf·ft]		Free Speed [r.p.m]	Air Pressure [MPa]	Hose Dia. [mm]	Overall Length [mm]	Sq. Drive [mm]	Reaction Arm (Sold Separately)	Weight [kg]
	Min.-Max.	Grad.		Min.-Max.	Grad.		Min.-Max.	Grad.							
AP220N2	100-220		AP22M2	10-22		AP160F2	80-160	5	277			275	19.0	SA400N/UA450N	4.7
AP400N2	200-400	10	AP40M2	20-40	1	AP300F2	150-300	10	175			364	25.4	SA700N/UA900N	6.7
AP700N2	300-700	20	AP70M2	30-70	2	AP500F2	220-500	10	79	0.5	φ12	375	31.75	SA1200N/UA1800N	8.1
AP1200N2	600-1200	50	AP120M2	60-120	5	AP900F2	450-900	25	46			508	31.75	UA3000N	15
AP2200N2	1000-2200		AP220M2	110-220		AP1600F2	800-1600	50	19.2			541	38.1	UA4500N	22
AP4000N2	2000-4000	100	AP400M2	200-400	10	AP3000F2	1500-3000	100	12						

- Note**
1. Reaction arm, such as UA or SA, must be used when operating AP models in order to absorb reaction force.
 2. Use pneumatic sockets only.
 3. Through hole type S.q drive.

Standard Accessories W5 hex key

Optional Accessories

SA Shell Arm
Light Weight Reaction Arm

RoHS

Refer to page 68.



AP1200N2 with SA, Socket

UA Universal Arm
Heavy Duty Reaction Arm

RoHS

Refer to page 68.



AP700N2 with UA, Socket



ME/MC2

Multiple Unit/
Pneumatic
Straight Style

Automatic

Straight

Pneumatic

Graduation

Master Valve Operation

RoHS

Direction



ME126N

MC400N2-TC

- Several units used simultaneously with loader
- Fully automatic tightening for complex bolt configurations

Accuracy ±5%

S.I. Model	Torque Range [N·m]		Metric Model	Torque Range [kgf·cm/kgf·m]		American Model	Torque Range [lbf·in/lbf·ft]		Free Speed [r.p.m]	Air Pressure [MPa]	Hose Dia. [mm]	Overall Length [mm]	Square Drive [mm]	Weight [kg]
	Min.-Max.	Grad.		Min.-Max.	Grad.		Min.-Max.	Grad.						
ME25N	10-25		M250E2	100-250		M250E2-A	90-220		1050			420.6 (457.6)	9.5	4.7
ME45N	20-45	0.5	M450E2	200-450	5	M450E2-A	200-400	5	540					5.3
ME80N	35-80	1	M800E2	350-800	10	M800E2-A	310-700	10	310	0.4	φ7.5	424 (461)	12.7	
ME126N	50-126	2	M1260E2	500-1260	20	M1260E2-A	35-90	2	200					5.7
MC220N2	100-220		MC22M2	10-22		MC160F2	80-160		277					
MC400N2	200-400	10	MC40M2	20-40	1	MC300F2	150-300	10	175			287.5	19.0	4.6
MC700N2	300-700	20	MC70M2	30-70	2	MC500F2	220-500	20	79			376	25.4	6.7
MC1200N2	600-1200	50	MC120M2	60-120	5	MC900F2	450-900	50	46	0.5	φ8	388	31.75	8.1
MC2200N2	1000-2200		MC220M2	100-220		MC1600F2	700-1600	100	19.2			491	31.75	17
MC4000N2	2000-4000	100	MC400M2	200-400	10	MC3000F2	1500-3000	100	12			522	38.1	24

- Note**
1. Overall length in () is the length with TC sensor.
 2. Auto-reverse/auto-reset functions.
 3. For designing a multi-spindle system, check the PCD, minimum distance between the spindles.
 4. Add "-TC" for sensor-equipped version.
 5. For first-time user, consult Tohnichi for assistance.

Standard Accessories Torque adjusting bar

Optional Accessories for Multiple Unit

Handle Valve, Supportive Handle

Part #	Type	Air Outlet	Overall Length [mm]	Application
188	Handle Valve	3/8	135	For Direct Connection
189	Handle Valve	1/8		Master Valve
187	Handle Assist	-	125	-

Switch Handle, Switch

Part #	Type	Application
331	Start Switch Handle	Multiple Unit Start Switch
332	Reset Switch Handle	Reset Switch
333	Quick Reverse Handle	Emergency Reset Switch

Slide Drive for ME, DCME

Model
FDME25N
FDME80N
FDME126N
FDME400N
FDME1200N

Master Valve

Part #	Application	Air Outlet x Air Supply x Number of Branch
		(ΦD) x (φd) x (n)
195	MF	1/2 x 1/4 x 4
196	ME	1/2 x 1/4 x 6
197	MC	3/4 x 3/8 x 2
198		1 x 3/8 x 4
199		1 x 3/8 x 6

Slide Drive for MC2

Model
FDMC400N
FDMC1200N

Torque Sensor

Model	Applicable Model
TC-ME2	ME
TC-MCA	MC220N2, MC400N2
TC-MCB-2	MC700N2
TC-MCB	MC1200N2



DOTE4-G

Digital Torque Wrench Tester

Calibration

Digital

Manual Handle

Direct Reading

RoHS

Direction



- Multiple units of measure through keypad setup
- "Loading system" stabilizes wrench during calibration procedure for optimal results.
- RS232C and USB output
- Max. 1000 measured data can be stored.



DOTE100N4-G

CE



DOTE1000N4-G

Accuracy ±1%+1 digit

Model	Torque Range										Torque Wrench Max. Effective Length [mm]	Inlet Drive [mm]	Weight [kg]	Down Adapter		Hex Adapter [mm]					
	cN-m		N-m		kgf-cm		kgf-m		lbf-in					lbf-ft			Part #	[mm]			
	Min.-Max.	1 digit	Min.-Max.	1 digit	Min.-Max.	1 digit	Min.-Max.	1 digit	Min.-Max.	1 digit				Min.-Max.	1 digit						
DOTE20N4-G	200.0-2000.0	0.2	2,000-20,000	0.002	20.00-200.00	0.02	-	-	18.00-180.00	0.02	-	-	410	9.5	12	296 (P.68)	6.35	10, 13, 19			
DOTE50N4-G	-	-	5.00-50.00	0.005	50.0-500.0	0.05	-	-	44.0-440.0	0.05	3.60-36.00	0.005				12.7	13	-	277 (P.44)	6.35	12, 14, 17
DOTE100N4-G	-	-	10.00-100.00	0.01	100.0-1000.0	0.1	-	-	88.0-880.0	0.1	7.30-73.00	0.01	660	19.0	-				297 (P.68)	9.5	17, 22, 27
DOTE200N4-G	-	-	20.00-200.00	0.02	200.0-2000.0	0.2	-	-	170.0-1700.0	0.2	15.00-150.00	0.02							1020	47	-
DOTE500N4-G	-	-	50.0-500.0	0.05	-	-	5.00-50.00	0.005	440-4400	0.5	36.0-360.0	0.05	1750	25.4	49	299 (P.68)	19.0	22, 27, 29			
DOTE1000N4-G	-	-	100.0-1000.0	0.1	-	-	10.00-100.00	0.01	880-8800	1	73.0-730.0	0.1				-	-	-	-	-	30, 32, 36

- Note
1. Auto-zero adjustment function.
 2. Statistical function includes the number of sampling, max/min/mean values.
 3. AC Adapter BA-6 (AC100-240V+/-10%) comes with

DOTE4-G Optional Accessories

Hex Adapter

Part #	Size [mm]
285	3/8-7-8-9
286	1/2-16-18-21
287	1/2-17-22-27
288	1/2-19-24-30

Connecting Cable (P.50)

Part #	Applicable Model
383	DOTE4-G - PC, EPP16M3 (D-SUB 9 Pin Female)
385	DOTE4-G - PC (USB A-Type)

Printer (P.69)

Model
EPP16M3

Data Filing System (P.69)

Model
DFS

- Note
1. () shows pin shape of the connecting cables.
 2. Contact Tohnichi for other types of connecting cables.

DOT

Analog Torque Wrench Tester

Calibration

Dial Indicating

Manual Handle

Direct Reading

RoHS

Direction



- Dial indicating
- For clockwise testing
- Mechanical loading device



DOT100N

Accuracy ±2%

S.I. Model	Torque Range [N-m]		Metric Model	Torque Range [kgf-cm]		American Model	Torque Range [lbf-in/lbf-ft]		Torque Wrench Max. Effective Length [mm]	Inlet Drive [mm]	Weight [kg]	Standard Accessory				
	Min.-Max.	Grad.		Min.-Max.	Grad.		Min.-Max.	Grad.				Down Adapter (Female) [mm]	Hex Adapter (Male) [mm]			
							lbf-in	lbf-ft								
DOT35N	5-35.0	0.1	350DOT	50-350	1	DOT300I	50-300	1	410	9.5	8	#296 (6.35)	10, 13, 19			
DOT50N	5-50.0	0.2	500DOT	50-500	2	DOT430I	50-430	2				12.7	-	-	#277 (6.35), #297 (9.5)	12, 14, 17
DOT100N	10-100.0	0.5	1000DOT	100-1000	5	DOT1000I	100-1000	5	660	19	10				-	17, 22, 27
DOT300N	30-300	1	3000DOT	300-3000	10	DOT200F	20-200	1							1260	25
DOT700N	70-700	2	7000DOT	700-7000	20	DOT500F	50-500	2	-	-	-	-	22, 27, 29			

- Note
1. Measurement for clockwise direction only.

◆ Calibration Kit for DOITE4-G/DOT



* Sold separately. Refer to page 63.

DOTE4-G-MD2

Direction



Digital Torque Wrench Tester with Motor Driven Loader

- Suitable for large volume of calibrations
- Control loader with motor drive
- Motor drive can be retrofitted to DOTE4-G tester



DOTE500N4-G-MD2

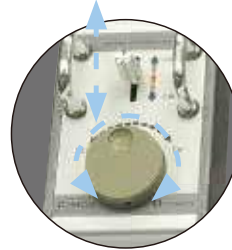

Controller unit with speed adjusting and inching function



DOTE4-G-MD2

Complete Tester with Motor Drive Set

Model
DOTE20N4-G-MD2
DOTE50N4-G-MD2
DOTE100N4-G-MD2
DOTE200N4-G-MD2
DOTE500N4-G-MD2
DOTE1000N4-G-MD2

Note
Select the plug shape A or C type when ordering.

MD2-SET

Retrofit Motor Driven Unit

Model	Construction unit				Applicable Model
	Motor Unit w/Limiter	Controller Unit	Power Unit	Power Cord	
MD2-SET-SA	M-MD2-S	C-MD2	DR-MD2-S	PC-MD2A	DOTE20N4-G to 200N4-G
MD2-SET-SC				PC-MD2C	
MD2-SET-LA			M-MD2-L	DR-MD2-L	
MD2-SET-LC	PC-MD2C				

Note
1. PC-MD2A come with A type plug for 100 - 125V.
PC-MD2C come with C type plug for 100 - 240V.



M-MD2-S
Motor and Limit Switch



C-MD2
Controller



DR-MD2-S
Motor power unit



PC-MD2A
Power cord

◆ Calibration Kit for DOTE4-G

* Sold separately.
Refer to page 63-64.

TCC2-G

Digital Torque Wrench Tester

Direction



TCC2-G Standard Accessories

Model	Hex Adapter	Down Adapter	Others
TCC100N2-G	<input type="checkbox"/> 12.7-W10, 13, 19 <input type="checkbox"/> 12.7-W12, 14, 17	DA3-2 DA4-3	(1) Cradle for PC display (2) AC adapter for PC display (3) Power cable
TCC100N2-D-G		DA4-3	
TCC500N2-G	<input type="checkbox"/> 12.7-W10, 13, 19 <input type="checkbox"/> 12.7-W12, 14, 17 <input type="checkbox"/> 19.05-W17, 22, 27 <input type="checkbox"/> 19.05-W19, 24, 30	DA4-3 DA6-4	
TCC1000N2-G	<input type="checkbox"/> 19.05-W17, 22, 27 <input type="checkbox"/> 19.05-W19, 24, 30 <input type="checkbox"/> 25.4-W36, 46 <input type="checkbox"/> 25.4-W41, 50	DA6-4 DA8-6	

Note Refer to page 64.

Calibration Digital Manual Handle Direct Reading

- Torque calibrator with data management software with wide torque range
- Calibration, adjustment, and data management for torque wrenches
- Multiple measuring unit
- Controlled by Tablet PC

Model	CH	Torque Range [N·m]		Torque Range [kgf·cm]		Torque Range [lbf·in]		Torque Wrench Max. Effective Length [mm]	Inlet Drive [mm]	Dimensions [mm]			Weight [kg]
		Min.-Max.	1 digit	Min.-Max.	1 digit	Min.-Max.	1 digit			Overall Length	Width	Height	
TCC100N2-G	1	4-100	0.01	40-1000	0.1	35.5-885	0.1	575	12.7	714	388	375	35
	2	1-25	0.002	10-250	0.02	9-220	0.02	482	9.53				
TCC100N2-D-G	1	4-100	0.01	40-1000	0.1	35.5-885	0.1	575	12.7				
	2	20-600 cN·m	0.05 cN·m	2-60	0.005	2-50	0.005	482	6.35				
TCC500N2-G	1	20-500	0.05	200-5000	0.5	180-4400	0.5	1035	19.05	1206	502	430	75
	2	4-100	0.01	40-1000	0.1	36-880	0.1	769	12.7				
TCC1000N2-G	1	50-1000	0.1	500-10000	1	445-8800	1	1700	25.4	1906	574	526	115
	2	20-500	0.05	200-5000	0.5	180-4400	0.5	1212	19.05				

TCC2-G Specifications

Display	10 inch Tablet PC
Tool Management Function	Torque wrench/driver registration date, measurement date memory (model, serial number, measurement point, measurement count, accuracy level, channel, measurer, past record) Maximum data amount (1000pcs worth) is based on testing torque wrenches of single force direction. When testing bi-direction torque wrenches such as BQSP, it will be less than 1000pcs)
Measurement Mode	Click mode / direct reading mode / manual mode
Zero Adjustment	Automatic (press C key)
Operating Temperature	0 - 40 °C
Power	100 ~ 240V 50/60Hz

◆ Calibration Kit for TCC2-G

* Sold separately. Refer to page 63.



TF Fully Automatic Digital Torque Wrench Tester

Direction



TF2000N

- Calibration
- Digital
- Electric Power
- Direct Reading
- Fully Automatic

- Tool Management System with computer
- Ideal for Calibration Labs
- Fully automatic testing, judging, and data processing

Accuracy ±1%+1digit

Model	CH	Inlet Drive	Torque Range										Dimensions			Weight [kg]	Adapter		
			[N-m]		[kgf-cm]		[kgf-m]		[lbf-in]		[lbf-ft]		[mm]				Hex	Ratchet	Down
			Min.-Max.	1 digit	Min.-Max.	1 digit	Min.-Max.	1 digit	Min.-Max.	1 digit	Min.-Max.	1 digit	Min.-Max.	1 digit	L	W			
TF200N	1	12.7	5-200	0.05	50-2000	0.5	0.5-20	0.005	50-1700	0.5	5-140	0.05	1860			240	□12.7-17-22-27 □12.7-19-24-30 □9.53-10-13-19 □9.53-12-14-17 □19.05-22-27-29 □19.05-30-32-36	RA3mk2 RA4mk2	DA3-2 DA4-3
	2	9.53	0.5-20	0.005	5-200	0.05	0.05-2	0.0005	5-170	0.05	0.5-14	0.005							
TF500N	1	19.05	20-500	0.2	200-5000	2	2-50	0.02	200-4500	2	20-370	0.2				315	□25.4-36-46 □25.4-41-50 □12.7-17-22-27 □12.7-19-24-30 □9.53-10-13-19 □9.53-12-14-17	RA3mk2 RA4mk2 RA8mk2	DA3-2 DA6-4
	2	9.53	2-50	0.02	20-500	0.2	0.2-5	0.002	20-450	0.2	2-37	0.02							
TF1000N	1	25.4	25-1000	0.25	250-10000	2.5	2.5-100	0.025	250-8500	2.5	25-700	0.25	2160	550	930	380	□25.4-36-46 □25.4-41-50 □12.7-17-22-27 □12.7-19-24-30 □9.53-10-13-19 □9.53-12-14-17	RA3mk2 RA4mk2 RA8mk2	DA3-2 DA4-3 DA8-6
	2	12.7	5-200	0.05	50-2000	0.5	0.5-20	0.005	50-1700	0.5	5-140	0.05							
	3	9.53	0.5-20	0.005	5-200	0.05	0.05-2	0.0005	5-170	0.05	0.5-14	0.005							
TF2000N	1	25.4	100-2100	1	1000-21000	10	10-210	0.1	1000-18000	10	100-1500	1	2660			415	□25.4-36-46 □25.4-41-50 □19.05-22-27-29 □19.05-30-32-36 □9.53-10-13-19 □9.53-12-14-17	RA3mk2 RA6mk2 RA8mk2	DA3-2 DA4-3 DA8-6
	2	19.05	20-500	0.2	200-5000	2	2-50	0.02	200-4500	2	20-370	0.2							
	3	9.53	2-50	0.02	20-500	0.2	0.2-5	0.002	20-450	0.2	2-37	0.02							
TF3000N	1	38.1	200-3000	1	2000-30000	10	20-300	0.1	2000-25000	10	200-2000	1	3160			450	□38.1-36-46 □38.1-41-50 □25.4-36-46 □25.4-41-50 □19.05-22-27-29 □19.05-30-32-36	RA6mk2 RA8mk2 RA12	DA6-4 DA8-6 DA12-8
	2	25.4	100-2100	1	1000-21000	10	10-210	0.1	1000-18000	10	100-1500	1							
	3	19.05	20-500	0.2	200-5000	2	2-50	0.02	200-4500	2	20-370	0.2							

Note Refer to page 68 for adapters.

◆ Calibration Kit for TF

* Sold separately. Refer to page 63.

TDT3-G Digital Torque Screwdriver Tester

Direction



TDT600CN3-G with loading device (Model: STA)



- Calibration
- Digital
- Manual Rotary
- Direct Reading
- Loading Device

RoHS

- Ideal for testing click and indicating type torque screwdrivers
- Newly added judgment function and USB output
- Multiple units of measure through keypad setup
- Optional TDTLA3 for testing small torque wrenches and LTA for indicating type torque screwdrivers

Accuracy ±1%+1digit

Model	Torque Range								Inlet Drive	Dimensions [mm]			Weight [kg]
	cN-m		kgf-cm		ozf-in		lbf-in			[mm]	Overall Length	Width	
	Min.-Max.	1digit	Min.-Max.	1digit	Min.-Max.	1digit	Min.-Max.	1digit					
TDT60CN3-G	2-60	0.005	0.2-6	0.0005	3-80	0.005	0.2-5	0.0005	6.35 Hex (Male)	230	220	225	11
TDT600CN3-G	20-600	0.05	2-60	0.005	30-800	0.05	2-50	0.005	with a groove (0.7mm)				

Note 1. Loading device keeps stable measuring conditions to avoid reading errors.
2. Max 1,000 measured data can be stored.

Standard Accessories 1. AC Adapter/BA-6, 2. Loading Device/STA

■ TDT3-G Optional Accessories

Connecting Cable (P.50)

Part #	Applicable Model
383	TDT3-G - PC, EPP16M3
385	TDT3-G - PC

Loading Device

Model
TDTLA3
LTA
STA

As for TDTLA3, TDT600CN3-G measures 2-60 cN-m and TDT600CN3-G measures 20-600cN-m range of torque wrenches. LTA is for direct reading torque drivers such as FTD and STC. STA is for tightening torque driver such as RTD and LTD.

Printer (P.69)

Model
EPP16M3

Data Filing System (P.69)

Model	Media
DFS	CD-ROM

Hex Adapter

Part #	Description
480	1/4-5-8-12
481	1/4-6-10-13
482	1/4-7-11-14
483	1/4-16-19-22
484	1/4-17-21-24

Loading Device Adapter for TDT/TDT2-G

Part #	Description
485	TDTLA3 to TDT, TDT2-G
486	STA, LTA to TDT, TDT2-G

◆ Calibration Kit for TDT3-G



* Sold separately. Refer to page 63.

LC3-G Torque Wrench Line Checker

Direction



CE

LC3-G Standard Accessories Hexagon Head Adapter

Part #	Applicable Model	Square Drive [mm]	Hex Size (Male) [mm]
282	LC20N3-G	9.5	8, 10, 12, 13, 14, 17
280	LC200N3-G	12.7	8, 10, 12, 13, 14, 17, 19, 22

Socket Adapter (P.44)

Part #	Applicable Model	Inlet Drive [mm]	Hex Size (Male) [mm]
1282	LC20N3-G	6.35	9.5
1280	LC200N3-G	9.5	12.7
274	LC1000N3-G	12.7	19.0
276	LC1400N3-G	19.0	25.4

Calibration Kit for LC3-G/ST3-G

* Sold separately. Refer to page 63.

Checking **Digital** Manual Loading Direct Reading

RoHS

- For daily inspections of torque wrenches
- Newly added judgment function and USB output
- Multiple units of measure through keypad setup

Accuracy ±1%+1digit

Model	Mode	Torque Range												Inlet Drive [mm]	Weight [kg]
		cN·m		N·m		kgf·cm		kgf·m		lbf·in		lbf·ft			
		Min.-Max.	1 digit	Min.-Max.	1 digit	Min.-Max.	1 digit	Min.-Max.	1 digit	Min.-Max.	1 digit	Min.-Max.	1 digit		
LC20N3-G	Run	50.0-2000.0	0.2	0.500-20.000	0.002	5.00-200.00	0.02	-	-	5.00-174.00	0.02	-	-	9.53	10.5
		50.0-99.8		0.500-0.998		5.00-9.98				5.00-9.98					
	Peak	100-999	1	1.00-9.99	0.01	10.0-99.9	0.1	-	-	10.0-99.9	0.1	-	-		
LC200N3-G	Run	-	-	5.00-200.00	0.02	50.0-2000.0	0.2	-	-	50.0-1740.0	0.2	4.00-140.00	0.02	12.7	10.5
		-	-	5.00-9.98		50.0-99.8		-	-	50.0-99.8		4.00-9.98			
	Peak	-	-	10.0-99.9	0.1	100-999	1	-	-	100-999	1	10.0-99.9	0.1		
LC1000N3-G	Run	-	-	50.0-1000.0	0.1	-	-	5.00-100.00	0.01	500-8800	1	36.8-735.0	0.1	25.4	34
		-	-	100-1000	1	-	-	10.0-100.0	0.1	1000-8800	10	100-735	1		
	Peak	-	-	100-1000	1	-	-	10.0-100.0	0.1	1000-8800	10	100-735	1		
LC1400N3-G	Run	-	-	100.0-1400.0	0.2	-	-	10.0-140.00	0.02	900-12000	2	75.0-1000.0	0.2	25.4	39
		-	-	100-999	1	-	-	10.0-99.9	0.1	900-998	2	75.0-99.8	0.2		
	Peak	-	-	1000-1400	10	-	-	100-140	1	1000-9990	10	100-1000	1		

- Note**
1. Dimensions: L278mm x W160mm x H167mm (LC20N3-G, LC200N3-G)
L500mm x W290mm x H186mm (LC1000N3-G)
L500mm x W313mm x H186mm (LC1400N3-G)
 2. TCL, calibration kit is optional, refer to page 63.
 3. Max. 1000 measured data can be stored.

Standard Accessories AC Adapter/BA-6, AC100-240V±10%

LC3-G Optional Accessories

Connecting Cable (P.50)

Part #	Applicable Model
383	LC3-G - PC, EPP16M3
385	LC3-G - PC

Note Contact Tohnichi for other connector shapes.

Printer (P.68)

Model
EPP16M3

Data Filing System (P.67)

Model	Media
DFS	CD-ROM

ST3-G ST3-G-BT

SPINTORK/Rotary Peak Torque Meter

Direction



ST3-G/ST3-G-BT Optional Accessories

Extension Bar

Part #	Applicable Model
283	ST10N3-G-BT
281	ST20N3-G-BT, ST50N3-3/8-G-BT
247	ST50N3-1/2-G-BT, ST100N3-G-BT, ST200N3-G-BT
248	ST500N3-G-BT
249	ST1000N3-G-BT

* Bluetooth is a registered trademark of Bluetooth SIG, Inc.

Checking **Digital** Re-Chargeable Direct Reading

RoHS

- Ideal for checking nutrunner torque output and angle
- Data output through USB (ST3-G) and Bluetooth® (ST3-G-BT)
- Tightening torque value can be detected by every 1° degree in Bluetooth® version.

ST3-G/ST3-G-BT Specifications

Torque Accuracy	+/- 1% +1digit
Angle Range	0 to 999°
Angle 1 digit	1°
Angle Accuracy	+/- 2°+1digit
Measuring Direction	Bi-direction
Display	7 segment LCD; Unit, Battery life, Direction Counter value: 3 digits (3mm height) Torque and angle value: 3 digits (7mm height)
Measuring Mode	PEAK/RUN
Data Memory	999
Data Output	USB / Bluetooth® -BT models
Continuous Duty	10 hours / 5 to 8 hours -BT models
Power	Built-in Ni-MH (Nickel hydrogen) battery pack
Operating Temperature	0-40 °C
BT Communication Distance	10m
Other Functions	Auto Memory/Reset (0.5-5 seconds variable), Auto Power Off (3/10/30 mins, Non), Display of remaining battery level (4 levels)

Accuracy ±1%+1digit

Model	Torque Range												Overall Length [mm]	Inlet/Outlet Drive [mm]	Weight [kg]		
	N.m		cN.m		kgf.cm		kgf.m		ozf.in		lbf.in					lbf.ft	
Standard Version	Bluetooth® Version	Min.-Max.	1digit	Min.-Max.	1digit	Min.-Max.	1digit	Min.-Max.	1digit	Min.-Max.	1digit	Min.-Max.	1digit	Min.-Max.	1digit	Min.-Max.	1digit
ST10N3-G	ST10N3-G-BT	(0.50)2-10	0.01	200-1000	1	20-100	0.1	0.2-1	0.001	285-1400	1	18-88	0.1	1.5-7.3	0.01	75	6.35
ST15N3-6.35-G	ST15N3-6.35-G-BT	(1.00)4-15	0.02	400-1500	2	40-150	0.2	0.4-1.5	0.002	570-2100	2	36-131	0.2	3-11	0.02	106.5	Hex 6.35
ST20N3-G	ST20N3-G-BT	(1.00)4-20	0.02	400-2000	2	40-200	0.2	0.4-2	0.002	570-2800	2	36-175	0.2	3-14.5	0.02	9.53	0.25
ST50N3-3/8-G	ST50N3-3/8-G-BT	(2.50)10-50	0.05	1000-5000	5	100-500	0.5	1-5	0.005	1420-7000	5	90-440	0.5	7.5-36.5	0.05	75	12.7
ST100N3-G	ST100N3-G-BT	(5.0)20-100	0.1	-	-	200-1000	1	2-10	0.01	-	-	180-880	1	15-73	0.1	12.7	1.3
ST200N3-G	ST200N3-G-BT	(10.0)40-200	0.2	-	-	400-2000	2	4-20	0.02	-	-	360-1750	2	30-145	0.2	19.05	1.3
ST500N3-G	ST500N3-G-BT	(25.0)100-500	0.5	-	-	1000-5000	5	10-50	0.05	-	-	900-4400	5	75-365	0.5	120	19.05
ST1000N3-G	ST1000N3-G-BT	(50)200-1000	1	-	-	-	-	20-100	0.1	-	-	150-735	1	135	25.4	1.3	

- Note**
1. Not for use with impact wrenches or pulse type tools.
 2. Graph of angle and torque can be created in Bluetooth® version.
 3. Data output of Bluetooth® version is through Bluetooth® only.
 4. As for your local condition of wireless equipment certification acquisition, contact to Tohnichi or distributor.
 5. The values in () indicate minimum snug torque values. Accuracy cannot be guaranteed for snug torque set beyond the operative torque range.

Standard Accessories 1. Quick Battery Charger/BC-4-2 2. CD-ROM (USB Driver) 3. USB Connecting Cable/384 4. Carrying Case



ATG/BTG

Analog Torque Gauge

Dial Indicating 3-jaw Chuck Direct Reading

Direction



ATG6CN



BTG36CN

- Compact portable handheld design
- Top and side scales for easy reading
- Three fingered keyless chuck

Accuracy ±2%

S.I. Model	Torque Range [cN-m]		Metric Model	Torque Range [gf-cm/kgf-cm]		American Model	Torque Range [ozf-in/lbf-in]		Chuck Grip [mm]	Dimensions [mm]		Weight [kg]
	Min.-Max.	Grad.		Min.-Max.	Grad.		Min.-Max.	Grad.		Overall Length	Outside Diameter	
ATG045CN	0.05-0.45	0.01	45ATG	5-45	1	ATG06Z	0.06-0.6	0.01	φ1-φ6.5	89	43.5	0.18
ATG09CN-S	0.1-0.9	0.02	90ATG-S	10-90	2	ATG1.5Z-S	0.2-1.5	0.02				
ATG1.5CN-S	0.2-1.5		150ATG-S	20-150		ATG2.4Z-S	0.3-2.4	0.05				
ATG3CN-S	0.3-3	0.05	300ATG-S	30-300	5	ATG4.5Z-S	0.5-4.5	0.1				
ATG6CN-S	0.6-6	0.1	600ATG-S	60-600	10	ATG9Z-S	1-9	0.2				
ATG12CN-S	1-12	0.2	1200ATG-S	100-1200	20	ATG18Z-S	2-18	0.5				
ATG24CN-S	3-24	0.5	2400ATG-S	300-2400	50	ATG36Z-S	4-36	0.5				
-	-	-	-	-	-	BTG60Z-S	6-60	1				
-	-	-	-	-	-	BTG120Z-S	10-120	2				
BTG15CN-S	2-15	0.2	1.5BTG-S	0.2-1.5	0.02	1.5BTG-A-S	0.1-1.5	0.02				
BTG24CN-S	3-24	0.5	2.4BTG-S	0.3-2.4	0.05	2.4BTG-A-S	0.3-2.4	0.02				
BTG36CN-S	4-36		3.6BTG-S	0.4-3.6		3.6BTG-A-S	0.4-3.6	0.05				
BTG60CN-S	6-60	1	6BTG-S	0.6-6	0.1	6BTG-A-S	0.6-6	0.1				
BTG90CN-S	10-90		9BTG-S	1-9		9BTG-A-S	1-9	0.1				
BTG150CN-S	20-150		15BTG-S	2-15		15BTG-A-S	2-15	0.2				

ATG Optional Accessories

Part #	Description
322	Plastic Case and Chuck

- Note**
1. ATG045CN, 45ATG and ATG06Z are provided without side or top memory pointer.
 2. "Without memory pointer" models are available. Remove "S" from the model name when ordering. Ex. ATG09CN, BTG15CN
 3. Aluminum case and steel chuck are standard for ATG models. Plastic case and chuck can be ordered separately.
 4. Continuously repeating a back and forth CW and CCW movement may cause damage to the internal spring.

ATGE-G

Digital Torque Gauge

Digital 3-jaw Chuck Direct Reading Battery

Direction



ATGE5CN-G



- Digital torque gauge with pull out display
- For measurement, inspection and tightening of low torque range
- 3 way configuration; hand-held, table top or as a torque meter with testing fixture

Accuracy ±2%+1digit

Model	Torque Range								Chuck Grip [mm]	Dimensions [mm]		Weight [kg]
	[cN-m]		[mN-m]		[gf-cm]		[ozf-in]			Overall Length	Outside Diameter	
	Min.-Max.	1 digit	Min.-Max.	1 digit	Min.-Max.	1 digit	Min.-Max.	1 digit				
ATGE05CN-G	0.1-0.5	0.001	1-5	0.01	10-50	0.1	0.15-0.7	0.001	φ1-6.5	120	67	0.305
ATGE1CN-G	0.2-1	0.001	2-10	0.01	20-100	0.1	0.3-1.4	0.001				
ATGE2CN-G	0.4-2	0.002	4-20	0.02	40-200	0.2	0.6-2.8	0.002				
ATGE5CN-G	1-5	0.005	10-50	0.05	100-500	0.5	1.5-7	0.005				
ATGE10CN-G	2-10	0.01	20-100	0.1	200-1000	1	3-14	0.01				
ATGE20CN-G	4-20	0.02	40-200	0.2	400-2000	2	6-28	0.02				

Note Aluminum case and steel chuck are standard for ATGE-G models. Plastic case and chuck/322 (page 60) is sold separately.

Standard Accessories Carrying case

ATGE-G Common Specifications

Direction	CW/CCW
Display	7 segment LCD display, Counter 3 digits (character height 3mm), Torque value: 4 digits (character height 7mm) Torque unit, Battery indicator, Direction
Mode	PEAK/RUN
Data Memory	999 readings
Statistic Processing	Sample size, Max. value, Min. value, Mean value
Data Output	USB output (USB mini B connector)
Power	Coin-type lithium battery (CR2450)
Continuous in Use	approx. 10 hours when using coin battery
Other Functions	Auto power off (3 min.), Auto memory reset (0.5-5) seconds variable, Auto zero adjustment, Residual battery indicator (4 steps), Buzzer ON/OFF, Unit Conversion
Operating Temperature	0-40 °C
Standard Options	Carrying case

Calibration Kit for ATG/BTG/ATGE-G/BTGE-G



* Sold separately. Refer to page 63.

Data Receiver Software

The Data Receiver software allows for the transfer of collected torque data from various Tohnichi digital torque equipment into a Microsoft® Excel® worksheet or CSV file. Tohnichi also provides customized software upon request.



Data Receiver

BTGE-G

Digital Torque Gauge

Digital 3-jaw Chuck Direct Reading Battery

RoHS

Direction



- Multiple units of measure through keypad setup
- For measurement, inspection and tightening of low torque ranges
- Flip-up display can be adjusted for optimal reading

Accuracy $\pm 2\% + 1\text{digit}$

CE



BTGE200CN-G

Model	Torque Range								Chuck Grip [mm]	Dimensions [mm]		Weight [kg]
	[cN·m]		[kgf·cm]		[ozf·in]		[lbf·in]			Overall Length	Outside Diameter	
	Min.-Max.	1 digit	Min.-Max.	1 digit	Min.-Max.	1 digit	Min.-Max.	1 digit				
BTGE10CN-G	2-10	0.01	0.2-1	0.001	3-14	0.01	0.2-0.88	0.001	φ1-φ8.5	130	75	0.65
BTGE20CN-G	4-20	0.02	0.4-2	0.002	6-28	0.02	0.4-1.7	0.002				
BTGE50CN-G	10-50	0.05	1-5	0.005	15-70	0.05	1-4.4	0.005				
BTGE100CN-G	20-100	0.1	2-10	0.01	30-140	0.1	2-8.8	0.01				
BTGE200CN-G	40-200	0.2	4-20	0.02	60-280	0.2	4-17	0.02				

Note 1. Can be used for checking accuracy of torque screwdrivers.
2. Max 999 readings can be saved with statistical function max/min/mean values.

BTGE-G Optional Accessories

Connecting Cable (P.50)

Part #	Applicable Model
384	BTGE-G (USB mini B) - PC (USB A)

Measurement Board

Model
809

ATG/BTG/ATGE-G/BTGE-G Optional Accessories



No.808

ATGE-G/BTGE-G Measurement stand
To firmly fix ATGE-G/BTGE-G to use as table top configuration

Part #	Applicable Model
808	ATGE-G
809	BTGE-G



No.800

Table attachment
4 poles are designed to clamp objects of any shape (Chucking diameter φ10-φ58)

Part #	Applicable Model
800	ATGE-G/BTGE-G



No.806

Calibration adapter for ATGE-G/BTGE-G
Adapter for calibration devices, ATGTCL/BTGTCL, to mount on ATGE-G/BTGE-G

Part #	Applicable Model
806	ATGE-G
807	BTGE-G



BA-7

Adapter for USB connector
External power supply adapter for ATGE-G/BTGE-G with using USB connecting cable.

Part #	Applicable Model
BA-7	ATGE-G/BTGE-G



No.384

USB connecting cable
Cable for external USB data output or connecting BA-5

Part #	Applicable Model
384	ATGE-G/BTGE-G



No.322

Plastic chuck
Plastic chuck for fragile objects

Part #	Applicable Model
322	ATG/ATGE-G



ATGE-G with table attachment and measurement stand



AMRD torque checking with ATGE-G and measurement stand, #808.



BMRD torque checking with BTGE-G.



BTGE-G with table attachment and measurement stand



TME2

Digital Torque Meter

Direction



2TME500CN2



Digital Pole Clamping Direct Reading

- Ideal for testing torque on bottle caps
- Up to 99 measured data can be stored.

Accuracy ±1%+1digit

S.I. Model	Torque Range [cN·m]		Metric Model	Torque Range [gf·cm/kgf·cm]		American Model	Torque Range [ozf·in/lbf·in]		Chuck Size [mm]	Dimensions [mm]			Weight [kg]
	Min.-Max.	1 digit		Min.-Max.	1 digit		Min.-Max.	1 digit		Overall Length	Width	Height	
3TME10CN2	2.00-10.00	0.01	3TME10CN2-M	200-1000	1	3TME10CN2-Z	2.80-14.00	0.01	φ14-φ110	252	158	185	3.5
3TME20CN2	4.00-20.00	0.02	3TME20CN2-M	400-2000	2	3TME20CN2-Z	5.60-28.00	0.02					
3TME50CN2	10.00-50.00	0.05	3TME50CN2-M	1000-5000	5	3TME50CN2-Z	14.00-70.00	0.05					
3TME100CN2	20.0-100.0	0.1	3TME100CN2-M	2.00-10.00	0.01	3TME100CN2-Z	28.00-140.0	0.1	φ18-φ190	331	223	283	12
2TME200CN2	40.0-200.0	0.2	2TME200CN2-M	4.00-20.00	0.02	2TME200CN2-I	3.50-17.00	0.02					
2TME500CN2	100.0-500.0	0.5	2TME500CN2-M	10.00-50.00	0.05	2TME500CN2-I	8.80-44.00	0.05					
2TME1000CN2	200-1000	1	2TME1000CN2-M	20.0-100.0	0.1	2TME1000CN2-I	17.6-88.00	0.1					
2TME2000CN2	400-2000	2	2TME2000CN2-M	40.0-200.0	0.2	2TME2000CN2-I	35.0-175.0	0.2					

- Note**
1. Can be used for checking accuracy of torque screwdrivers.
 2. Max. 99 measured data can be stored.
 3. TMTCL, calibration kit is optional.
 4. Statistical Data: Hi, Lo, Sample, Ave., Range Variation, and Standard Deviation

- Standard Accessories**
1. AC Adapter/BA-4
 2. Rubber Nail
 3. Supportive Plate for 2TME2

TME2 Optional Accessories

Connecting Cable (P.50)

Part #	Applicable Model
383	TME2 - PC, EPP16M3

Printer (P.69)

Model
EPP16M3

Data Filing System (P.69)

Model	Media
DFS	CD-ROM

TM

Analog Torque Meter

Direction



2TM400CN

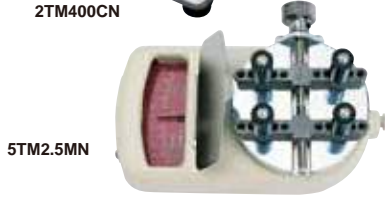

5TM2.5MN

Pole Clamping Direct Reading

- Dial indicating
- Wide variety of torque testing ranges

Accuracy ±2%

S.I. Model	Torque Range [mN·m/cN·m]		American/Metric Model	American Torque Range [lbf·in]		Metric Torque Range [kgf·cm/gf·cm]		Dimensions [mm]				Weight [kg]	
	Standard	With Memory Pointer		Min.-Max.	Grad.	Min.-Max.	Grad.	Min.-Max.	Grad.	Overall Length	Width		Height
4TM10MN	4TM10MN-S	1-10	0.2	4-TM100-A-S	0.01-0.086	0.002	10-100	2	252	158	109.5	φ14-φ110	3
4TM15MN	4TM15MN-S	1.5-15	0.5	4-TM150-A-S	0.02-0.13	0.005	15-150	5					
4TM25MN	4TM25MN-S	2.5-25		4-TM250-A-S	0.025-0.215		25-250						
4TM50MN	4TM50MN-S	5-50	1	4-TM500-A-S	0.05-0.43	0.01	50-500	10					
4TM75MN	4TM75MN-S	8-75	2	4-TM750-A-S	0.08-0.65	0.02	80-750	20					
3TM10CN	3TM10CN-S	1-10	0.2	3-TM1-A-S	0.1-0.86	0.02	0.1-1	0.02					
3TM15CN	3TM15CN-S	1.5-15	0.5	3-TM1.5-A-S	0.15-1.3	0.05	0.15-1.5	0.05					
3TM25CN	3TM25CN-S	2.5-25		3-TM2.5-A-S	0.25-2.15		0.25-2.5						
3TM50CN	3TM50CN-S	5-50	1	3-TM5-A-S	0.5-4.3	0.1	0.5-5	0.1					
3TM75CN	3TM75CN-S	8-75		3-TM7.5-A-S	0.8-6.5	0.2	0.8-7.5	0.2					
2TM100CN	2TM100CN-S	10-100	2	2-TM10-A-S	1-8.6	0.2	1-10	0.2					
2TM150CN	2TM150CN-S	20-150		2-TM15-A-S	2-13		2-15						
2TM200CN	2TM200CN-S	30-200		2-TM20-A-S	3-17		3-20						
2TM300CN	2TM300CN-S	30-300	5	2-TM30-A-S	3-26	0.5	3-30	0.5					
2TM400CN	2TM400CN-S	40-400		2-TM40-A-S	3.5-35		4-40						
2TM500CN	2TM500CN-S	50-500		2-TM50-A-S	4-43		5-50						
2TM600CN	2TM600CN-S	60-600	10	2-TM60-A-S	5-50	1	6-60	1					
2TM750CN	2TM750CN-S	80-750		2-TM75-A-S	7-65		8-75						

- Note**
1. "-S" models are provided with a memory pointer.
 2. Continuously repeating a back and forth CW and CCW movement may cause damage to the internal spring.

Low Capacity, below 7.5 mN·m, Torque Meter

Accuracy ±2%

S.I. Model	Torque Range [mN·m]		Metric Model	Torque Range [gf·cm]		American Model	Torque Range [ozf·in]		Dimensions [mm]				Weight [kg]
	Min.-Max.	Grad.		Min.-Max.	Grad.		Min.-Max.	Grad.	Overall Length	Width	Height	Chuck Size	
5TM1MN	0.2-1	0.05	5-TM10	2-10	0.5	5-TM015Z	0.02-0.15	0.005	122	76.5	59	φ6-φ58	0.3
5TM1.5MN	0.2-1.5		5-TM15	2-15		5-TM020Z	0.04-0.2	0.01					
5TM2.5MN	0.5-2.5	5-TM25	5-25	5-TM035Z	0.05-0.35								
5TM5MN	1-5	5-TM50	10-50	5-TM070Z	0.3-0.7	0.02							
5TM7.5MN	1-7.5	5-TM75	10-75	5-TM1Z	0.2-1	0.05							

- Note**
1. 5TM models are supplied without memory pointer.
 2. When calibrating the 5TM models, ask Tohnichi for assistance.

◆ Calibration Kit for TME2/TM



* Sold separately. Refer to page 63.

TCF

Fixed Type Torque Sensor

Voltage Output Fixed

RoHS

• Requires CD5 to display torque reading



CD5

*Display is sold separately.



TCF20N

S.I. Model	Torque Range [N-m]	Metric Model	Torque Range [kgf-cm]	American Model	Torque Range [lb-in/lbf-ft]	Inlet Drive [mm]	Dimensions		Weight [kg]
	Min.-Max.		Min.-Max.		Min.-Max.		Height [mm]	Diameter [mm]	
TCF02N	0.02-0.2	TCF1.8	0.18-1.8	TCF1.8I	lb-in	6.35	56	45	0.45
TCF04N	0.04-0.4				0.18-1.8				
TCF1N	0.1-1	TCF18	1.8-18	TCF18I	lb-in	9.5	66	70	0.5
TCF2N	0.2-2				1.8-18				
TCF4N	0.4-4	TCF180	18-180	TCF180I	lb-in	12.7	100	105	2.5
TCF10N	1-10				18-180				
TCF20N	2-20	TCF1800	180-1800	TCF150F	lb-ft	19.0	135	140	6
TCF40N	4-40				180-1800				
TCF100N	10-100	TCF18000	1800-18000	TCF1500F	lb-ft	25.4	180	178	12
TCF200N	20-200				1800-18000				
TCF400N	40-400								
TCF1000N	100-1000								
TCF2000N	200-2000								

Note 1. TCL, calibration kit is optional.
2. Display, CD5, is sold separately.

Standard Accessories Connecting Cable

TCF Optional Accessories

TP, Test Piece: Torque measurement for power torque tools



TP18N+TCF20N

Model	Torque Range			Applicable TCF Model	Inlet		Dimensions		Weight [kg]
	S.I. [N-m]	Metric [kgf-cm]	American [lb-in/lbf-ft]		Width Across Flats [mm]	Nominal Size of Screw	Diameter [mm]	Height [mm]	
	Min.-Max.	Min.-Max.	Min.-Max.						
TP2.5N	0.25-2.5	2.5-25	2-22	TCF02N-TCF4N	8	M4	18	58	0.08
TP18N	1.8-18	18-180	16-160	TCF10N, TCF20N	13	M6	35	83.5	0.27
TP180N	18-180	180-1800	30-130	TCF40N-TCF200N	24		65	148	1.9
TP1800N	180-1800	1800-18000	130-1300	TCF400N-TCF2000N	50		140	297.5	16.8

Note 1. Adapter 4H-3 (#273) is necessary for TCF40N.
2. Adapter 8P-6 (#295) is necessary for TCF400N.



DTF5-2+TCF20N

DTF, Drill Chuck: Torque measurement for axial work pieces

Model	Applicable TCF Models	Chuck Size [mm]	Square Drive [mm]	Dimensions	
				Diameter [mm]	Height [mm]
DTF5-3	TCF02N-TCF4N	Max. φ5	6.35	33	65
DTF5-2	TCF10N-TCF40N	Max. φ5	9.5		61



TTF11+ATF18+TCF20N

TTF/ATF, Table and fixture: Ideal for testing torque on bottle caps

Model	Applicable TCF	Chuck Size [mm]	Table Dia. [mm]
TTF	ATF		
TTF7	ATF18-2	φ10-70	φ70
TTF11	ATF18	φ14-110	φ110
TTF19	ATF18-2	φ18-190	φ180
	ATF18		

Note ATF attachment is required to fix TTF table.

TCR

Rotary Type Torque Sensor

Voltage Output Rotary

RoHS

• Captures directly applied torque
• Requires CD5 to display torque reading



CD5

*Display is sold separately.



TCR18N

S.I. Model	Torque Range [N-m]	Metric Model	Torque Range [kgf-cm]	American Model	Torque Range [lb-in/lbf-ft]	Allowable Rotation [r.p.m]	Square Drive [mm]	Height [mm]	Width [mm]	Weight [kg]
	Min.-Max.		Min.-Max.		Min.-Max.					
TCR18N	1.8-18	TCR180	18-180	TCR180-A	lb.in	2000	9.5	91	76	0.9
TCR180N	18-180	TCR1800	180-1800	TCR1800-A	lb.ft					
TCR700N	70-700	TCR7000	700-7000	TCR7000-A	13-130	1000	12.7	104	83	1.3
TCR1800N	180-1800	TCR18000	1800-18000	TCR18000-A	50-500					
					130-1300		19.0	118.5	95	2.0
							25.4	138.5	110	3.6

Note 1. TCL, calibration kit is optional.
2. Display, CD5, is sold separately.

Standard Accessories Connecting Cable

◆ Calibration Kit for TCF/TCR



* Sold separately. Refer to page 63.



Calibration Kit

◆ Calibration Kit for DOT/DOTE Series

RoHS

Model	Description					Applicable Model
	Calibration Lever	Stand	Reaction Unit	Scale Holder	Wire	
DOTCL-S1	KL-DOTCL36N	KS-DOTCL-S	RU-DOTCL100N	WT0.5	Wire x 2	DOT35N, DOT50N DOTE20N, DOTE36N DOTE20N3-G, DOTE50N3-G DOTE20N4-G, DOTE50N4-G
DOTCL-S2	KL-DOTCL100N					DOT100N DOTE100N DOTE100N3-G DOTE100N4-G
DOTCL-S3	KL-DOTCL200N		RU-DOTCL360N	WT1		DOTE200N DOTE200N3-G DOTE200N4-G
DOTCL-S4	KL-DOTCL360N					DOT300N DOTE360N DOT700N DOTE700N DOTE500N3-G
DOTCL-L1	KL-DOTCL700N	KS-DOTCL-L	RU-DOTCL700N	WT5	Wire x 2	DOTE1000N DOTE1000N3-G DOTE500N4-G
DOTCL-L2	KL-DOTCL1000N		RU-DOTCL1000N4			WT5
DOTCL-L3	KL-DOTCL700N			DOTE1000N4-G		
DOTCL-L4	KL-DOTCL1000N					



DOTCL-S2

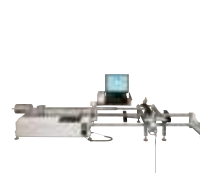

TFTCL2000N



TCCTCL-S2

◆ Calibration Kit for TCC2-G

RoHS

Model	Description					Applicable Model
	Calibration Lever	Stand	Reaction Unit	Scale Holder	Wire	
TCCTCL-S1	KL-DOTCL36N KL-DOTCL100N	KS-DOTCL-S	RU-TCC100N2	WT0.1	Wire x 2	TCC100N2-G
TCCTCL-S2	KL-TDCL600CN KL-DOTCL100N			WT1		Wire x 3
TCCTCL-L1	KL-TCTCL100N-7 KL-DOTCL700N	KS-DOTCL-L	RU-TCC500N2	WT0.5, WT1 WT5	Wire x 4	TCC500N2-G
TCCTCL-L2	KL-DOTCL700N KL-TCCTCL1000N		RU-TCC1000N2	WT1 WT5		Wire x 2



TCL200N



TDCL600CN

◆ Calibration Kit for TF

RoHS

Model	Description					Applicable Model
	Calibration Lever	Stand	Scale Holder	Wire		
TFTCL200N	KL-DOTCL200N KL-DOTCL36N	KS-TFTCL	WT0.1 WT1	Wire x 4	TF200N	
TFTCL500N	KL-DOTCL36N KL-DOTCL360N		WT0.5, WT1 WT5-TF		TF500N	
TFTCL1000N	KL-DOTCL200N KL-DOTCL36N KL-DOTCL1000N		WT0.1 WT1 WT5-TF		TF1000N	
TFTCL2000N	KL-DOTCL36N KL-DOTCL360N KL-DOTCL2100N		WT0.5 WT1 WT5-TF		TF2000N	
TFTCL3000N	KL-DOTCL360N KL-TCL2100N KL-TCL3000N		WT1		TF3000N	
			WT5-TF			



2TMTCL



ATGTCL24CN

◆ Calibration Kit for TDT3-G

RoHS

Model	Description	Applicable Model
TDCL60CN	Calibration Lever x 1, Wire x 1, Calibration Roller x 1, Scale Pan (100g) x 1, Scale Holder (1kg) x 1,	TDT60CN3-G
TDCL600CN	Calibration Lever x 1, Wire x 1, Calibration Roller x 1, Scale Pan (100g) x 1, Scale Holder (1kg) x 1	TDT600CN3-G

◆ Calibration Kit for TME2/TM

RoHS

Model	Description	Applicable Model
2TMTCL	Wire x 1, Roller x 1, Frame x 1, Bolt x 2, Scale Holder (1kg) x 1, Scale Pan (100g) x 1	2TM/2TME2
3TMTCL	Wire x 1, Roller x 1, Frame x 1, Bolt x 2, Scale Pan (5g x 1, 100g x 1)	3TM/3TME2
4TMTCL	Wire x 1, Roller x 1, Frame x 1, Bolt x 2, Scale Pan (3g x 1, 5g x 1, 100g x 1)	4TM

◆ Calibration Kit for LC3-G/ST3-G/TCF/TCR

RoHS

Model	Description	Applicable Model
TCL50N	Calibration Lever, Wire, Scale Holder (1kg), Scale Pan (100g)	TCF10N-TCF40N, TCR18N LC20N3-G, ST10N3-G-ST50N3-1/2-G
TCL200N	Calibration Lever, Wire, Scale Holder (1kg)	TCF100N-TCF200N, TCR180N LC200N3-G, ST100N3-G-ST200N3-G
TCL800N	Calibration Lever, Wire, Scale Holder (10kg)	TCF400N, TCR700N, ST500N3-G
TCL1000N	Calibration Lever, Wire, Scale Holder (5kg)	TCF1000N, ST1000N3-G, LC1000N3-G
TCL2000N	Calibration Lever, Wire, Scale Holder (10kg)	TCF2000N, TCR1800N, LC1400N3-G

Note 1. TCL1000N and TCL2000N are supplied upon request.
2. #271 is required when calibrating ST10N2-G.

◆ Calibration Kit for ATG(E)/BTG(E)

RoHS

Model	Description	Applicable Model
ATGTCL24CN	Main Unit, Calibration Pulley x 2, Wire x 2, Scale Pan (5g, 100g)	ATG/ATGE-G
BTGTCL150CN	Main Unit, Calibration Pulley x 2, Wire x 3, Scale Pan (5g, 100g)	BTG/BTGE-G

Note 1. Adapter (#807) is required when calibrating BTGE-G models.
2. Adapter (#806) is required when calibrating ATGE-G models.

◆ Weight

RoHS

Model	Weight
WP-TCL5	5kg
WP-TCL2	2kg
WP-TCL1	1kg
WS-TCL2	Weight Set (2kg)

Note 1. Calibration certificates for weights are available upon request for a fee.
2. If there is no request for calibration, serial number will not be stamped.

Calibration Kit

◆ Comparison Table of Calibration Stands Component Units.

From the newly released Calibration kit, reviewed the product composition to make it easy to select only necessary parts. Consult to Tohnichi for selection of Calibration Kit.

Group	Calibration Stand	Applicable Model		Calibration Stand													Special Attachment																					
		S.I. model	Metric, Multi Unit Model	Spirit Level	Clamp Knob	Adjust Nut	Calibration Frame	Stand Weight	Nut	Adjustment Foot	Adjustment Tool A AD-DOTCL-A	Adjustment Tool B 10mm AD-DOTCL-B	Adjustment Tool C 40mm AD-DOTCL-C	Adjusting Tool D 113mm AD-TCCTCL2	Joint Rod A 380mm JR-DOTCL-A	Joint Rod B 480mm JR-DOTCL-B	Joint Rod C 180mm JR-DOTCL-C	Calibration Adapter KA-TCCTCL2	Calibration Parts P-TCCTCL100N-D	Joint Rod for TCC JR-TCCTCL2																		
DOTCL-S1	KS-DOTCL-S	DOT35N	350DOT																																			
		DOT50N	500DOT																																			
		DOE20N	200DOE2																																			
		DOE36N	360DOE2																																			
		DOE20N3	DOE20N3-G																																			
		DOE50N3	DOE50N3-G																																			
DOE20N4		DOE20N4-G																																				
DOE50N4		DOE50N4-G																																				
DOTCL-S2		DOT100N	1000DOT																																			
		DOE100N	1000DOE2																																			
		DOE100N3	DOE100N3-G																																			
		DOE100N4	DOE100N4-G																																			
DOTCL-S3	DOE200N	2000DOE2																																				
	DOE200N3	DOE200N3-G																																				
	DOE200N4	DOE200N4-G																																				
DOTCL-S4	DOT300N	3000DOT																																				
	DOT360N	3600DOT2																																				
TCCTCL-S1	TCC100N2	TCC100N2-G																																				
TCCTCL-S2	TCC100N2-D	TCC100N2-D-G																																				
DOTCL-L1	KS-DOTCL-L	DOT700N	7000DOT																																			
		DOE700N	7000DOE2																																			
		DOE500N3	DOE500N3-G																																			
DOTCL-L2		DOE1000N	10000DOE2																																			
		DOE1000N3	DOE1000N3-G																																			
DOTCL-L3		DOE500N4	DOE500N4-G																																			
		DOE1000N4	DOE1000N4-G																																			
TCCTCL-L1		TCC500N2	TCC500N2-G																																			
		TCCTCL-L2	TCC1000N2																																			
Previous KS-DOTCL Component																																						

Note

- Refer to above table and page 59 for required units when additionally purchase a calibration unit.
- Confirm the component of your DOTCL/TCCTCL and if you need, purchase the parts of Calibration Stand, Special Attachment, Lever and Reaction Unit for Calibrating tester.
- The previous "KS-DOTCL" is one of the components of the previous calibration kits model DOTCL36N/100N/200N/360N/700N/1000N.
- For TCC previous models, contact to Tohnichi.

Example of Combination

- Calibrate DOE1000N4-G with previous KS-DOTCL : Required an Adjusting Rod D 113mm "AD-TCCTCL2", and Calibration Lever and Reaction Unit of DOE1000N4-G and weights.
- Calibrate DOE500N4-G with DOTCL-S2 : Required an Adjusting Rod 113mm "AD-TCCTCL2", Joint Rod C 180mm "JR-DOTCL-C", and Calibration Lever and Reaction Unit of DOE500N4-G and weights.



TT3000 Ultrasonic Tension Meter



NEW

TT3000



Digital **Direct Reading**

- Non-destructive axial bolt tension tester
- Updated version of TT2000 model
- Enhanced the communication function, usability by touch panel

Model	TT3000
-------	--------

TT3000 Specifications

Measuring method	Ultrasonic pulse propagation time difference	
Measurement	Bolt axial tension	
Components	Main unit / Ultrasonic sensor / Thermocouple	
Applicable bolt length	5.00~25000.00 mm	
Applicable bolt diameter	More than M5 size	
Ultrasonic wave frequency	1~20 MHz	
Range of speed	500~20,000m/s	
Measuring items #1	Bolt Axial Tension / Bolt Initial Length / Elongation / Stress / Traveling Time	
Measuring items #2	Travelling Time, Length, Wave, Temperature	
Measuring resolution	Axial tension	0.1 kN / 0.01 kN
	Time	0.1 ns
	Elongation	0.0001 mm
Data updating	Measurement	0.04 sec
	Screen	0.2 sec
Capacity of data memory	2000 bolts	
Bolt temperature correction	Upto 50 different type of bolts	
	Key Input System, -100 to +500 C degree	
Detection method	Auto, Thermocouple Unit	
	Full Wave, Positive half wave, Negative half wave, RF Wave	
Display	Color TFT 7.5, 640 x 480 dots	
	Touch panel in a resistance film system	
External interface	Type K thermocouple Input - 1ch	
	USB - 1ch for serial communication	
	SD Card, SD/SDHC/SDXC, up to 64GB - 1ch	
	LAN, TCP/IP 1ch	
	VGA single monitor output - 1ch	
	Photo coupler inlet 4ch/outlet 4ch	
	Analog output 4~20mA 1ch, Max. load resistance 500Ω	
Power supply	Encoder input - 1ch	
	AC Adapter 100 - 240V, Output DC12V 60W	
Operating temperature	Built-in battery 11h usage, 4h battery charge	
	Enable to charge by AC adapter during use.	
Dimension	-10 to +60 C degree under AC adapter operation	
Weight	0 to +40 C degree under battery operation	
Body	H168 x W250 x D63.5mm	
Waterproof/dust proof	1.2 kg, w/o Battery	
Regulation	ABS	
	IP 20 when closing battery lid	
Language	CE Marking	
	Low voltage directive : 2014/35/EU	
	EMC directive 2014/30/EU	
Standard accessories	EU RoHS 2 directive 2011/65/EU	
	English / Japanese	
	Operation manual, Calibration test result, Traceability chart,	
	AC Adapter, ADT-060A12AAB-A, compliance with CE, AC power cable JP	
Standard accessories	Li-Ion battery, RRC2057, compliance with CE	
	USB cable, SD card, Power cable, sensor probe cable, sensor probe	
	Carrying handle, Aluminum case	

Note 1. Sensor probe is compatible with TT2000.

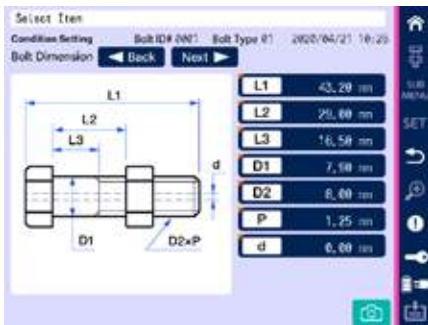

Bolt dimension input



B1 Echo confirmation



Waveform before & after giving loading



Measurement result data inquiry

TT3000 Optional Accessories

Model Name	AC Power Cable US
	AC Power Cable 220V
	Thermo Sensor
	Handle Plate
	Aluminum Case
	Sensor probe cable SCA-TT2000

TT2000

Ultrasonic Tension Meter



TT2000

Digital Direct Reading

- Non-destructive axial bolt tension tester
- Input information regarding fastener & materials
- Sound wave lengths are measured and compared.

Model
TT2000
TT2000C

TT2000 Specifications

Measuring Range	5-10,000mm (Steel material)
Applicable Length of Bolt	50-9,000mm
Applicable Nominal Diameter of Bolt	φ6mm dia or more (Applicable for less than φ6mm dia. with an optional sensor)
Ultrasonic Wave Frequency	0.5-15 MHz
Time Axis Resolution	5ns
Result of Measurement	Bolt initial length (mm), Stress (Mpa), Elongation (mm), Propagation rate (μs)
Measuring Resolution	Depends on bolt diameter and length [Ex.] Based on the first echo measurement (steel material) Bolt diameter φ10, Bolt tightening length 50mm ± approx. 1.47kN Bolt diameter φ20, Bolt tightening length 100mm ± approx. 2.94kN
Memory Capacity of Data	2,000pcs. or time pass measurement 300 items (Max. 50 kinds of different bolts can be registered)
Bolt Temperature Correction	Manual input by key, Auto temperature input *1
Display	Color TFT6.4 type (640 x 480dots)
External Output	8 bits serial interface (RS232C) *2 Composite output (NTSC), Alarm output (photo coupler), Encoder input *3
Power Supply	AC85-130V, AC185-265V (50/60Hz) or DC12V *4
Optional Battery	Portable: 2.5h use for 1.5h Charge Built-in case: 8h use for 4.5h charge
Operating Temperature	0-45 °C
Dimensions	Body: H160 x W246 x D60mm Body + Built-in battery: H160 x W246 x D246mm
Weight	Body: 1.2kg Body + built-in battery: 4.9kg

- Note**
1. Optional thermometer can be connected to TT2000C for auto temperature adjustment Input temperature range is from -40°C to 200°C. Measurement over 60°C requires a sensor specially designed for high temperature.
 2. RS232C connector is available only with TT2000C.
 3. DC12V can be used only when using the optional portable battery or the built-in battery case.

TT2000 Optional Accessories

Model Name
RS232C Junction Cable A
Portable Battery Cable
RS232C Junction Cable B



Ultrasonic Sensor

Part #	Name	Applicable Bolts
607	5C6.4N	More than M8, L1<approx.50mm
608	5C12.7N	More than M14, L1<approx.2m

- Note**
1. L1 is standard bolt length with material in SCM, S-C, SS for ultrasonic wave reflection measurement n=1.
 2. Ultrasonic wave sensor is consisting of 3 parts, Sensor, Magnet Holder and Bolt Holder.
 3. Standard 5C6.4N does not include bolt holder.
 4. 5C6.4N=[5: Frequency (MHZ)]
[C: Oscillator Material (C: piezoelectric ceramics)]
[6.4: Oscillator Diameter, mm]
[N: Perpendicular (Normal)]

Features of ultrasonic wave sensor

1. The magnetic holder provides stabilized force through the sensor, which provides high repeatability measurement.
2. The bolt holder gives same position of the sensor to support more accurate measurement.

NEW

Axial Tension Calibrator



AFC-20G2

Model
AFC-20G2

Accuracy ±2%+1digit

Axial Tension	Min. - Max.	20 to 200
Measurement Range [kN]	1 digit	0.01
Available Bolt Size (Reference) [mm]		Less than φ20mm, Bolt nominal length 45 to 300
	M10	45 to 80
	Standard accessory	(A nut with the same strength as the measurement bolt is required)
	M16	50 to 85
Dimensions [mm]	Standard accessory	(A nut with the same strength as the measurement bolt is required)
	M20	70, 87, 170, 187, Max.300
	Standard accessory	(A nut with the same strength as the measurement bolt is required)
Weight Approx. [kg]		55
Power		AC100 to 240V ±10% 50 / 60Hz
Temperature in Use		0 to 40°C Less than 85%RH (No condensation)

BTM/ B-BTM

Bolt Tension Meter **Dial Indicating** **Hydraulic** **Bourdon Type**

- Bourdon type hydraulic bolt tension meter
- Measure bolt tension to determine optimal torque

Accuracy ±3%

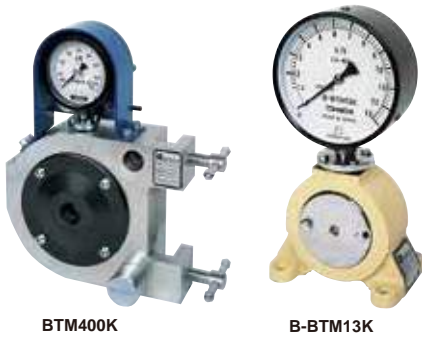

BTM400K

B-BTM13K

S.I. Model	Axial Tension Range [kN]		Metric Model	Axial Tension Range [ton]		American Model	Axial Tension Range [lbf]		Applicable Nominal Diameter of Bolts (Minimum Length) [mm]	Dimensions			Weight [kg]
	Min.-Max.	Grad.		Min.-Max.	Grad.		Min.-Max.	Grad.		Overall Length [mm]	Overall Thickness [mm]	Overall Height [mm]	
BTM400K	100-400	5	40BTM-2	10-40	0.5	40BTM-2-A	23000-90000	1000	Hexagon Bolt M16 (70), M20 (75) M22 (80), M24 (85) Torsia Bolt M16 (65), M20 (70) M22 (75), M24 (80)	260	64	280	12.6
B-BTM13K	1.2-13	0.2	1.3B-BTM	0.12-1.3	0.02	1.3B-BTM-A	300-2800	50	Standard Bolt M5 (20), M6 (21) M7 (22), M8 (23)	106	78	217	7.7
B-BTM40K	4-40	0.5	4B-BTM	0.4-4	0.05	4B-BTM-A	1000-9000	100	Standard Bolt M10 (29), M12 (31) M14 (32)	134	82	241	9.8
B-BTM130K	12-130	2	13B-BTM	1.2-13	0.2	13B-BTM-A	3000-28000	500	Standard Bolt M16 (41), M18 (43) M20 (44), M24 (47)	186	106	287	17.5
B-BTM400K	40-400	5	40B-BTM	4-40	0.5	40B-BTM-A	10000-90000	1000	Standard Bolt M27 (72), M30 (74) M36 (79), M42 (84)	280	126	369	31.0

Note 1. BTM400K comes with a plate and bushing for torsia bolt M20 and M22. Other size are optional.
2. "Hexagon Bolt" in the above list stands for the high-tensile hexagon bolt for friction bonding.

Standard Accessories Plate, Bushing, Spanner for plate, Bolt for plate, Storage Case, Calibration Certificate

BTM Optional Accessories

Bushing for Hexagon Bolt

Part #	Applicable Nominal Diameter of Bolts
650	M16
651	M20
652	M22
653	M24

Bushing for Torsia Bolt

Part #	Applicable Nominal Diameter of Bolts
665	M16
666	M20
667	M22
668	M24

Plate for Torsia Bolt/Hexagon Bolt

Part #	Applicable Nominal Diameter of Bolts
669	M16
670	M20
671	M22
672	M24

Fcon Bolt Tension Stabilization

RoHS

- Creates consistent bolt tension
- Applied to fasteners and nuts
- Acquisition of patent in EU.



Fcon

Model
Fcon

Sales Unit: 10pcs/case
Content: 90g/bottle

How to apply Fcon on the bolt (in case of M10 bolt)
Follow the illustration below. Apply some along the screw thread (2 mm width more or less), and on the bearing surface at 3 different spots evenly. Use appropriate amount depending on the size of the bolt.

* Apply Fcon on part indicated in color.

Axial Tension Stability Characteristics

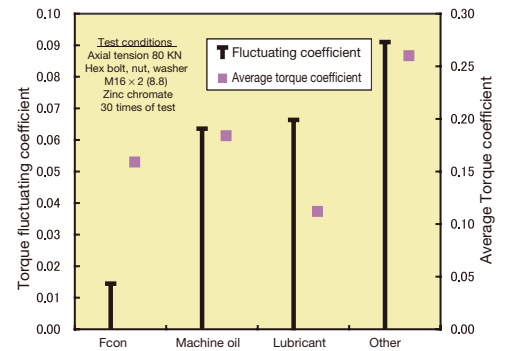

Characteristic of axial tension stabilization
Torque coefficient calculated by formula $K = t/(d \times f)$
T = tightening torque, d = nominal size of screw, F = axial tension
Torque fluctuating coefficient = torque coefficient standard deviation/average torque coefficient

Influence of Tightening Speed

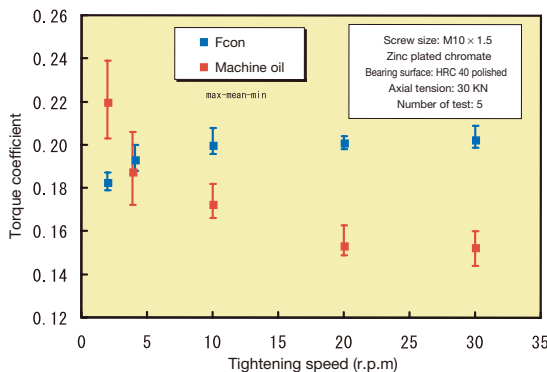

Influence of tightening speed on torque coefficient

Influence of Temperature

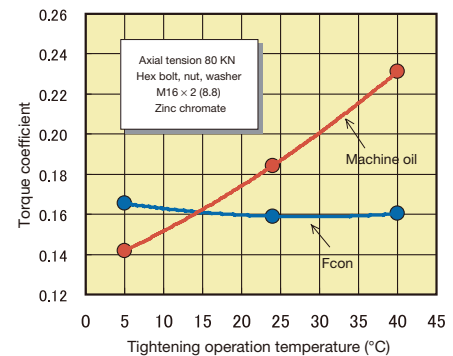

Influence of temperature on torque coefficient

TPC/TPC2

Protocol Converter

Auxiliary

RS232C/LAN Data Output

- Convert Tohnichi interface device format to other protocols
- Incorporate time and VIN data with tightening record by the internal clock and an optional barcode reader



TPC



TPC2

Model	Input/Output
TPC/TPC2	LAN x 1, RS232C x 2
Note	Display
To use custom made protocol function, required prior consult	Power Status LED x 1, Communication status LED x 1
Optional Accessories	Applicable Tohnichi Interface
AC Adapter	R-CM+M-FH/M-FD/M-BLA/M-BLE R-FH256, R-BLA, R-BLE, R-BT, CD5, R-FHD256 CEM3-BTA, PTA-G-BT
	TPC Available protocols
	ATLAS COPCO® ACOP Serial connection, ATLAS COPCO® ACOP Socket connection, STANLEY® Custom made Protocol*
	TPC2 Available protocols
	ATLAS COPCO® ACOP Serial connection, ATLAS COPCO® ACOP Socket connection, ATLAS ToolsNet® Custom made Protocol*
	Power
	DC24V 18V-38V / AC 100V-240 with optional AC adapter
	Dimensions
	W82 x D33 x H80mm
	Operating Temperature
	0-40 °C
	Weight
	146g

ATLAS COPCO, ToolsNet is registered trademark of Atlas Copco Aktiebolag
STANLEY is registered trademark of Stanley Logistics, LLC

Setting software



Protocol setting



IP address setting

• Convert Tohnichi Input/Output Format into a Variety of Protocols

Use as Protocol Converter and Serial to Ethernet device

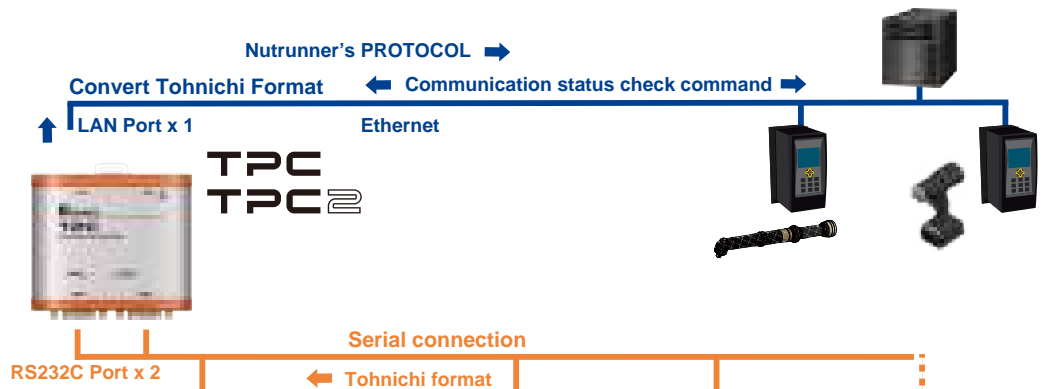

Tohnichi Interface Devices

Connected up to 2 Interface Devices of Tohnichi products at once.

R-CM Receiver box
Wireless torque wrenches systems FHM/FD/FD-D/FDD-AD

Interchangeable module
M-FH: Tightening count pokayoke
M-FD: Data transfer FD/FDD/FDD-AD
M-BL: Solar powered pokayoke

R-BT Receiver
Bluetooth® communication type data transfer torque wrenches

CD5 Display
Display of wired data transfer torque wrenches CSPLD/CSPLDC

CEM3-BTA/PTA-G-BT
Torque and angle monitoring, Bluetooth communication
* Need a RS232C-Bluetooth adapter for direct connection.



CD5

Compact Display



CD5



- Digital
- Sensor Contacts
- Direct Reading
- Comparator
- Judgment

- Digital display for Tohnichi's torque sensor, strain gauge, products
- OK or NG judgment capability with upper or lower limit setting function
- Easy to confirm judgment with blue and red digits displayed

Model CD5		Display	Negative type liquid crystal
		Resolution	±1/5000 (±1.0 to ±3.0mV/V) ±1/2000 (±0.5 to ±1.0mV/V) 1/2000 (+0.1 to +3.0mV/V)
		Input Voltage	±3.0mV/V
		Accuracy	Nonlinearity ±0.05% F.S. Zero point drift ±0.1µV/°C (TYP.) Gain drift ±0.01%/°C (TYP.)
		Calibration Methods	Equivalent input calibration Calibration by actual weight Calibration using sensor-equipped torque wrench
		Data Memory	1000 readings
		External Input	RESET/COMP/CLEAR/CHSW
		Communication	RS232C compliant, Analog output, HI, OK, LO relay output
		Power	AC100-240V±10%
		Operating Temperature	0-40 °C
		Dimension	150W × 190D × 94H
		Weight	approx. 1.8 kg

CD5 Optional Accessories

Printer

Model EPP16M3	
------------------	--

Data Filing System

Model	Media
DFS	CD-ROM

Connecting Cable (P.50)

Part #	Applicable Model	Plug
383	CD5 - PC, EPP16M3	D-SUB 9 Pin Female

EPP16M3

Printer

- Auxiliary
- RS232C Data Input

RoHS



EPP16M3

- Printer for digital torque equipment
- Terminal Line Dot printing

Model EPP16M3	
------------------	--

EPP16M3 Optional Accessories

Roll Paper

Part #	Description
1408	Roll Paper

Connecting Cable

Part #	Applicable Model	Plug
383	NOTE4-G/LC2/LC3-G/CD5/TDT2/TDT3-G/TME2	D-SUB 9 Pin Female
561	LC/TDT/CD42/TCC	
575	CEM2/CEM3-G/CEM3-P/CTA2-G/CTB2-G/R-DT999	
579	CTA/CTB	

EPP16M3 Specifications

Printed Mwidth	Thermal Line Dot
Total Dot	384 dots
Dots per inch	203 dpi (8dot/mm)
Printing Capacity	32
Number of Dots for Character	12 × 24
Character Size	1.5 × 3.0 mm
Paper Width/Print Span	58 / 48 mm
Thermal Paper Outer Diameter	φ50 mm
Max Printing Speed	80 mm/sec.
Power AC	100 - 240V ± 10% 50/60Hz
Operating Temperature	0 ~ 40 °C
Humidity [%RH]	Under 85 (No condensation)
Weight	approx. 0.27 kg

R-DT999

Data Tank

- Auxiliary
- Infrared Input
- RS232C/ Data Output



R-DT999

- Infrared data collector for torque equipment
- 999 data storage
- External keypad setup functions

Model R-DT999	
------------------	--

R-DT999 Optional Accessories

Printer

Model EPP16M3	
------------------	--

Data Filing System

Model	Media
DFS	CD-ROM

Connecting Cable (P.50)

Part #	Applicable Model	Plug
575	R-DT999 - PC, EPP16M3	D-SUB 9 Pin Female
584	R-DT999 - PC	USB A Type

Note Contact Tohnichi for other types of connector shapes.

Data Input	Infrared data input (Tohnichi format only)
Display	6 digits, 14segments LCD 4 digits, 7segments LCD 4 digits, 7segments LED
Applicable Model	CEM3-G, CEM2, ST, ST2, STC, CTA, CTB
Data Output	RS232C compliance, USB connector serial output (*USB 1.1)
Power	DC5V 2A
Dimensions	W80 × D125 × H32mm
Standard Accessories	AC adapter (100-240V±10%)
Operating Temperature	0-40 °C
Weight	205g (body only)

DFS

Data Filing System

- Auxiliary
- CD

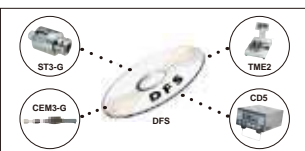

- Data processing software
- Statistics, Standard deviation, Cp values, Charts

Model DFS	Maximum value, minimum value, data range, mean value, standard deviation and Cp value are calculated to make a histogram on the display.
--------------	--

DECA/DECA2

10:1 Ratio Torque Multiplier

- Auxiliary
- Straight
- Rotary

- Multiplied torque output increases by 10 times
- Ideal for applying high torque values with less force
- DECA2 is improved usability by ratchet function and compact body

RoHS

Accuracy ±5%



DECA4500N

DECA1800N2

Model	Output Torque			Torque Ratio	Dimension [mm]			Weight [kg]	Applicable Universal Arm	
	[N·m]	[kgf·m]	[lbf·ft]		Overall Length	Dia.	Output Sq. Drive			Input Sq. Drive
	Min.-Max.	Min.-Max.	Min.-Max.							
DECA4500N2	90-450	9-45	65-325	10:1	151	52	19.07	9.53	UA450N	
DECA9000N2	180-900	18-90	130-650		190	63			25.4	12.7
DECA1800N2	360-1800	36-180	260-1300		228	77.5	31.75	19.05		
DECA3000N2	600-3000	60-300	434-2170		270	95			38.1	25.4
DECA4500N	900-4500	90-450	650-3250		367	110	50.8	60		
DECA9000N	1800-9000	180-900	1300-6500		464	140			63.5	60
DECA18000N	3600-18000	360-1800	2600-13000	540	172			UA18000N		

- Note
1. Universal Arm is optional.
 2. DECA9000N and DECA18000N are supplied on request.

- Standard Accessories
1. Metal Case (for DECA450N-DECA900N only)
 2. Portable Handle (for DECA4500N-DECA9000N only)
 3. Metal Case Caster (for DECA18000N only)



DECA450N2 with Universal arm & Torque wrench

AP2/DECA/DECA2 Optional Accessories



SA

UA

SA Shell Arm
• Light weight reaction arm

UA Universal Arm
• Heavy duty reaction arm

RoHS

RoHS

Model	Standard Socket Length [mm]	Max. Torque [N·m]	Weight [kg]
SA400N	50	400	0.7
SA700N	62	700	1.2
SA1200N	62	1200	1.6

Note: Cannot receive reaction force from counterclockwise direction, in this case use UA as the alternative.

Model	Max. Torque [N·m]	Weight [kg]
UA450N	450	1.2
UA900N	900	2.6
UA1800N	1800	4
UA3000N	3000	7.2
UA4500N	4500	10.9
UA9000N	9000	18
UA18000N	18000	30

Note: UA4500N/9000N/18000N are supplied on request.

Adapter for Torque Wrench Tester



Down Adapter



Ratchet Adapter

DA Down Adapter for Torque Wrench Testers
• Compact adapter to reduce the size of square drive

RoHS

Model	Part #	Dimensions [mm]			Capacity [N·m]	Weight [g]	
		Square Drive (Male)	Square Drive (Female)	Height			
DA3-2	296	9.5	6.35	12	13	14	5
DA4-3	297	12.7	9.5	15	18	70	11
DA6-4	298	19.0	12.7	19	28	220	34
DA8-6	299	25.4	19.0	26	35	750	66
DA12-8	300	38.1	25.4	44	55	2100	320

RA2 Ratchet Adapter for Torque Wrench Testers
• Rotates wrench to proper testing position on tester
• Gear action 3.75

RoHS

Model	Dimensions [mm]			Capacity [N·m]	Weight [kg]
	Sq. Drive (Male)	Sq. Drive (Female)	Height		
RA3mk2	9.5	9.5	37.3	70	0.28
RA4mk2	12.7	12.7	52.5	220	0.6
RA6mk2	19	19	69.3	850	2.3
RA8mk2	25.4	25.4	92.8	2100	6.3
RA12	38.1	38.1	111	3000	12.6

EVERTORQUE

Lubricant for repair



- For repairs of torque wrenches and torque screwdrivers

Model	Part #
EVERTORQUE	830

Evertorque Application List

RoHS

	Applicable Model	Applicable Part
Click Type Torque Wrench	QU/QLE/CLE/PQL/PCL/YCL	Thrusting; Steel Ball, Scale Piece, Adjusting Screw; Thread
	WQL	Thrusting; Steel Ball, Scale Piece, Adjusting Screw; Thread, Knob, Protector; Joint
Click Type Torque Screwdriver	MPQL	Thrusting; Steel Ball, Scale Piece, Adjusting Screw; Thread, Ratchet, Marker Pipe; Joint
	RTD, RNTD	Main Shaft, Toggle Sheet; Serration
Semi-Automatic Airtork	RTD, LTD, BMLD	Case, Adjusting Piece; Serration
Fully-Automatic Airtork	A/AC	Thrusting; Steel Ball, Scale Piece, Adjusting Screw; Thread
Multiple Unit	AP, AS	Reduction Clutch; Clutch
	MC, ME, DCME	



Tohnichi ISO6789:2017 compliance status

■ About ISO6789:2017 standard

To meet needs of manufacturers and calibration services, currently, the 2017 version of ISO6789 has been published, and its operation has started in Europe.

■ Main points of Changes

- The standard has been divided into two parts.
 - Part 1: defines design and manufacturing requirements, including the content of the Declaration of Conformity.
 - Part 2: sets out requirements, including how to calculate uncertainty for traceable calibration certificates.
- The contents and terms of the calibration certificate will change.
- The allowable range of posture during calibration has been changed. In addition, the calibration conditions have changed.
- The content related to resolution has been added.
- There are restrictions on the measurement error, measurement method, and environment of the measuring instrument used for calibration.

■ Tohnichi Actions

This ISO 6789-2017 standard applies from Tohnichi torque wrenches. Not applicable for some models, such as F series and small torque range wrenches. Tohnichi torque screwdriver series and digital torque wrench series will continue to apply the current ISO 6789-2003. Torque gauges and torque meters are not subject to ISO6789. Some Tohnichi dial indicating torque wrenches change their torque range according to the ISO6789-2017 standard requirements. Calibration certificate of the new standard is attached from the applicable model produced after January 2022.

- Some of DB, DBE, DB-S, DBE-S, CDB-S and T-S models in Nm and Metric units will be changed the minimum torque range in accordance with meeting the requirement of less than 5% of the resolution.

e.g.

Previous model

DB6N4

Torque range: 0.6-6Nm

Graduation : 0.1Nm

Accuracy : +/-3%



New model

DB6N5

Torque range: 0.7-6Nm

Graduation : 0.1Nm

Accuracy : +/-3%

- Requirement of ISO 6789:2017 specifies the resolution 1/5 of increment width*

* In the case the pointer tip width should be less than 1/5 of the scale or dial increment.

- Reading Accuracy should be 0.02Nm in ISO6789-2017 ($0.1\text{Nm} \times 1/5 = 0.02\text{Nm}$).

- 3% of the minimum torque 0.6Nm is 0.018Nm (Shortage of resolution).

- Change the minimum torque to 0.7Nm for the update model DB6N5 (3% of the minimum torque 0.7Nm, 0.021Nm is available with the resolution 0.02Nm).

■ Contents of calibration certificate changes

ISO6789:2017 Calibration certificate

校正証明書

Calibration Certificate

Date of First Used: / /

品名 トルクレンチ
Torque Wrench

型式 QL100N4

最小 / 最大トルク 20 / 100

単位 N-m

検査日 29/10/2020

Date of calibration (Day/Month/Year)

製造番号 088705J

Serial No. 3

相対測定誤差 ± (%) 25

Relative Measurement Error

検査時温度 (°C) 50

Temperature

検査時湿度 (%) -

Humidity

交換ヘッド使用時の有効長 相澤 栄治

Effective Length with interchangeable Head Inspector

検査担当者 E. Aizawa

088705J

3

25

50

-

相澤 栄治

E. Aizawa

検査ポイント Set Torque	作動方向 Direction	単位 Units	実測値 Actual Readings					平均 Average	相対誤差 不確かさ W % W. Relative Expanded MUJ	相対測定 不確かさ区間 W % W. Relative MUJ Interval
			1	2	3	4	5			
20 N-m	CW	N-m	20.6	20.5	20.5	20.4	20.4	20.5	2.105%	4.465%
		%	-2.91	-2.44	-2.44	-1.96	-1.96	-2.34		
		CCW	-	-	-	-	-	-	-	-
60 N-m	CW	N-m	60.0	60.0	59.9	59.8	59.8	59.9	0.735%	1.225%
		%	0.00	0.00	0.17	0.33	0.33	0.17		
		CCW	-	-	-	-	-	-	-	-
100 N-m	CW	N-m	101.7	101.6	101.6	101.9	101.8	101.7	0.490%	2.200%
		%	-1.67	-1.58	-1.58	-1.87	-1.77	-1.69		
		CCW	-	-	-	-	-	-	-	-

相対測定誤差の合格判定 合格

Judgment of Relative Measurement Error Pass

この校正成績書はISO6789:2017の要求事項に準拠した適合宣言であり、本製品は、国家標準にトレースされた参照標準を基準とした標準器を用い、上記規格に準拠した作業標準に従って校正が行われ、校正作業における検査または試験結果が製品仕様を満たしていることを証明します。
 We certify that product identified above was calibrated using reference standard. That is traceable to the national standards specifications and according to TOHNICHI standards.
 The measurement error of the torque measurement device is less than 1/4 of the maximum permissible relative deviation of the torque tool.
 (※相対測定不確かさ区間 W)とは、製品の相対測定誤差平均に相対標準不確かさと測定機器の相対測定誤差を足した数値です。
 (※Rel. MUJ interval W is the sum of the values. "Mean value of the relative measurement error", "Relative expanded measurement uncertainty" and "Stated relative measurement error")

標準器 Standard Equipment	型式 Model	製造番号 Serial No.	最大測定誤差/測定の不確かさ区間 Max. Measurement Error/ Measurement Uncertainty Interval	検査場所 Inspection Location
トルクレンチテスト Torque Wrench Tester	TISK400N-2	705239A	0.02%/0.30%	甲府工場 KOFU PLANT

参照標準 Reference Standard	公的機関 Official Facility	製造番号 Serial No.
参照用トルクレンチ RTW200 Reference Torque Wrench	(株)東日製作所 TOHNICHI MFG.CO.,LTD	701570Y
トルク基準機 DWTGM25 Torque Calibration Machine	(株)ミツトヨ(株)大正天びん製作所 MITUTOYO CORPORATION TAISHO BALANCE MFG.	706752B

株式会社 東日製作所

TOHNICHI MFG. CO., LTD

TOHNICHI MFG. CO., LTD KOFU PLANT

ISO9001 JQA-1536

発行責任者
Head of Calibration

H. Tsuneyoshi

植吉 英人 H.Tsuneyoshi

00512

ISO6789:2003 Calibration certificate

Certificate of Calibration

校正証明書

Name: TORQUE WRENCH

Model: QL100N4

Max. Capacity: 100

Units: N-m

Date of Calibration: 05/09/2018

(Day/Month/Year)

Date of First Used: / /

Serial No.: 145490J

Accuracy ± (%): 3

Temperature (°C): 26

Inspector: E. AIZAWA

Set Torque	Lower			Upper			Actual Readings				
20	19.5	20.6		CW	20.6	20.5	20.4	20.4	20.4	20.4	
60	58.3	61.8		CCW	60.3	60.3	60.2	60.1	60.0		
100	97.1	103.0		CW	101.5	101.4	101.3	101.2	101.2		
				CCW							

上記製品は、国家標準にトレースされた参照標準を基準とした標準器を用い、当社の作業標準に従って校正が行われ、校正作業における検査または試験結果が製品仕様を満たしていることを証明します。
 We certify that product identified above was calibrated using reference standard. That is traceable to the national standards specifications and according to TOHNICHI STANDARDS.
 We have verified that these test results comply with product specifications.
 Measured values are within tolerance according to ISO6789.
 The uncertainty of measurement of the reference standard use is ±1%.

標準器 Standard Equipment	型式 Model	製造番号 Serial No.
トルクレンチ TORQUE WRENCH TESTER	TISK1000N-2	706249F

参照標準 Reference Standard	公的機関 Official Facility	製造番号 Serial No.
参照用トルクレンチ RTW200 REFERENCE TORQUE WRENCH	(株)東日製作所 TOHNICHI MFG.CO., LTD	701570Y
トルク基準機 DWTGM25 TORQUE CALIBRATION MACHINE	(株)ミツトヨ(株)大正天びん製作所 MITUTOYO CORPORATION TAISHO BALANCE MFG.	706752B

株式会社 東日製作所

TOHNICHI MFG. CO., LTD

TOHNICHI MFG. CO., LTD KOFU PLANT

ISO9001 JQA-1536

発行責任者
Head of Calibration

H. Tsuneyoshi

植吉 英人 H.Tsuneyoshi

2-12, Omori-kita 2-Chome, Ota-ku, Tokyo 143-0016, Japan

TEL:03-3762-2452 FAX:03-3761-3852

00512

- Indicate minimum Torque value
- Change measurement points. Minimum - 60% - 100%
- Substitute "Maximum Permissible Relative Deviation" for "Accuracy"
- Indicate Humidity at the Inspection
- Indicate "Effective length" when using a replacement head
- Show "Actual Reading Value" and "Relative Measurement Error %" of each results
- Show the mean value of "Actual Reading" and "Relative Measurement Error %" of each points
- Show "Relative expanded measurement uncertainty" and "Relative measurement uncertainty interval"
- Indicate OK/Fail judgment whether the relative measurement error is within the permissible value
- Indicate the "Maximum Measurement Error" and "Measurement Uncertainty Interval" of the standard Equipment".
- Indicate the inspection Location

The new calibration certificate will be applied to ISO6789:2017 compatible products starting from January 2022, and the previous models will end in 2021

The current models, such as torque screwdrivers, digital torque wrenches and some single torque wrenches keep the current standard JIS B4652 complies with ISO6789:2003.

Technical Data



Torque Settings for Torque Screwdrivers

■ LTD, RTD, MLD

Method of setting torque, Adjustable type:

1. Turn the locker of the main unit clockwise to release the lock.
2. Holding the main scale knurling part with the fingers of your right hand, turn the grip with the fingers of your left hand to set the torque value.

* Setting the torque set values:

- (1) Turn the grip to match the top end of the supplemental graduation with the main scale.
- (2) Match the supplemental graduation line with the main scale vertical line (See the figure below).
3. After setting the torque, turn the main unit locker counterclockwise to lock it.

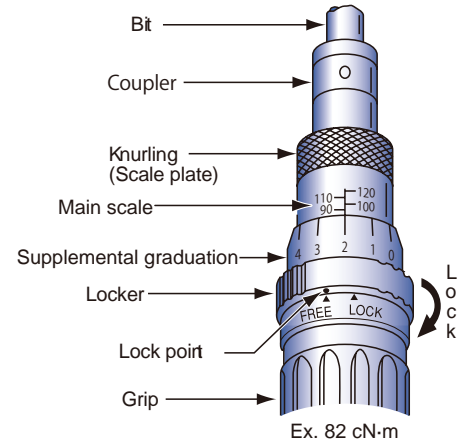

■ NTD, RNTD

Method of setting torque, Preset type:

1. Holding the grip with your left hand, insert the adjusting tool bar into the grooves of the adjustment screw and turn to adjust. Turn clockwise to increase the torque value.
2. Insert with the exclusive bit into the loading device of the Torque Driver Tester (TDT) and fix it.
3. Turn the loading device clockwise to measure the torque value.
4. Continue to repeat procedures 1-3 until the torque is matched.

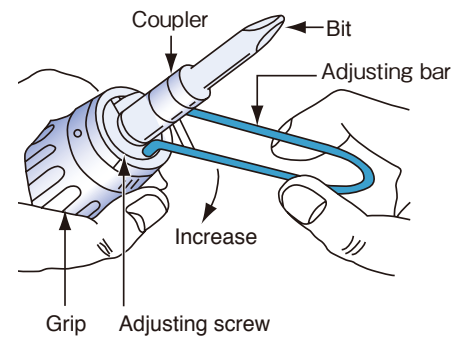

■ FTD50-400CN

Method of preloading the FTD

The preload function is a function that uses the handle to apply a preloading torque close to that of the measuring point to minimize the twisting angle during measurement.

In the FTD series torque screwdrivers, a preload function is provided to prevent your wrist from becoming strained and the torque scale from becoming difficult to read when operating close to the maximum torque.

1. Holding the FTD screwdriver with your left hand, turn the preload handle in the counterclockwise direction using the fingers of your right hand (in case of clockwise measuring).
2. After some slipping turns, the needle will begin to move, and it will be easy to set an optional torque value.
3. If you do not wish to use the preload function, turn the preload handle until there is no tension and the central set indicator (red mark) points to the FREE mark.

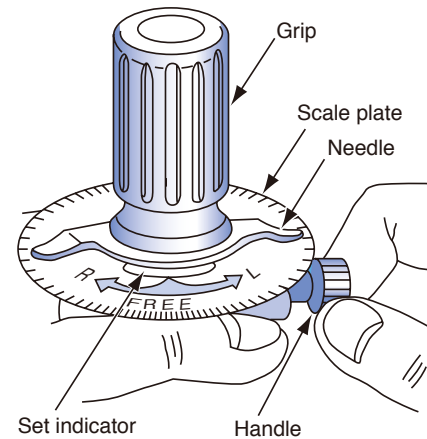

■ FTD-S

Method of setting the FTD-S indicator and memory pointer

1. Make sure the indicator is pointing to zero by matching the scale. If not, adjust to zero by lightly pushing down on the scale and rotating it.
2. Turn the memory pointer in the direction opposite to the measuring direction until it matches the main indicator.
3. Carry out torque measurement or torque tightening.

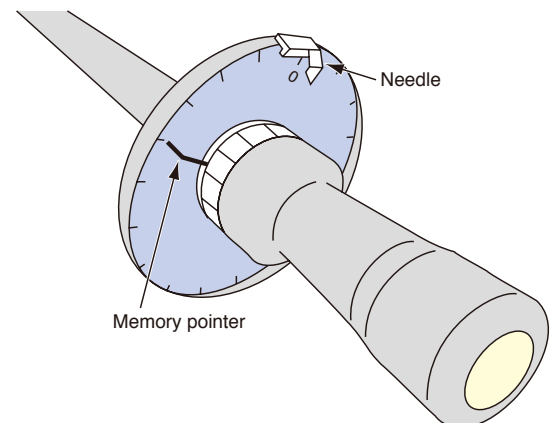

Torque Settings for Torque Wrenches

■ Adjustable type

● QL, QL5/CL, CL5

1. Turn the adjuster and match up the ▲mark of the adjuster and ▼mark of grip-end cap.
2. Pull the adjuster.
3. Pull the adjuster and turn it to set a torque.

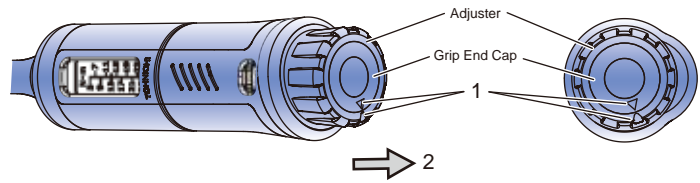

● QL, CL, YCL, A, etc.

1. Release the locker and turn it counterclockwise.
2. Set the torque by turning the supplemental graduation, confirming the value of the main scale.
3. Turn the locker clockwise to lock it. Change the locker pin location if the pin is contacted when locking.

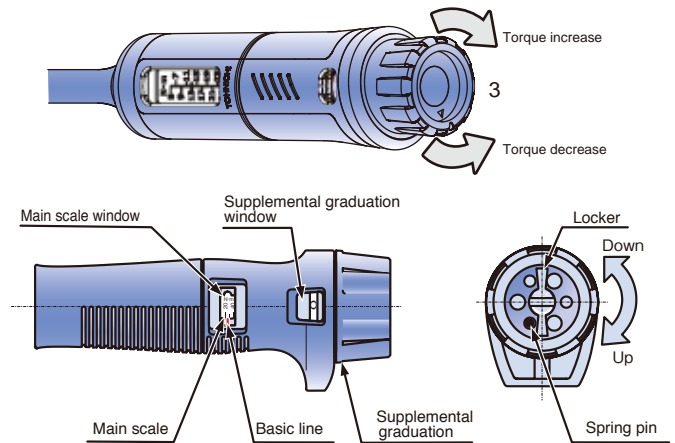

● QLE2, CLE2, DQLE2, and PHLE2

1. Press the push button
2. Remove the extension handle
3. Turning the adjusting handle clockwise to increase the set torque and counterclockwise to reduce it.

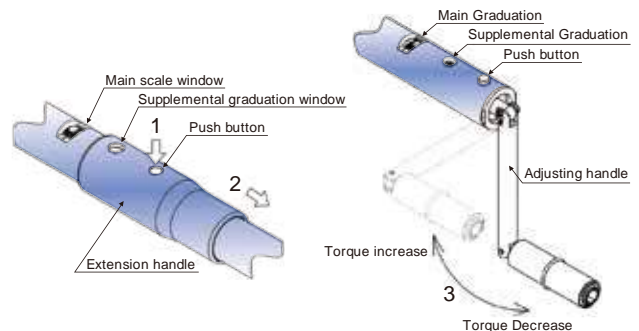

■ Pre-lock and preset types

● PQL, PCL, MPCL, AC2, QSP3, etc.

1. Insert the provided hexagon key into the adjusting hexagonal hole.
2. Turn the hexagon key to set the torque, confirming the value on the main scale and supplemental graduation.
3. No locking mechanism is needed for PQL models (An adjusting tool for QSP3 is optional).

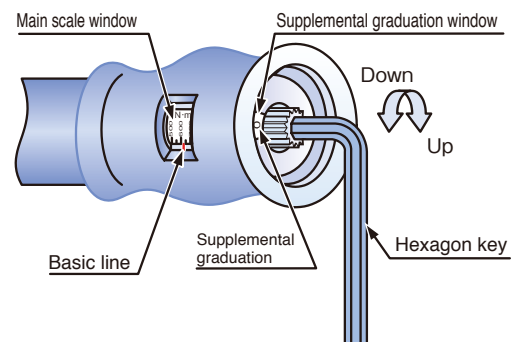

Model	Adjusting hexagon hole mm size across flats
PQL6N4-PQL25N	2.5
PQL50N-200N4	4
AC25N2-100N2	

■ Dial Indication types

● DB, CDB, T

1. For measurement
The scale on the dial gauge can be rotated. Press the dial case from above and turn the pointer to correctly match "0".
2. Presetting exclusively for tightening
Alternatively, the desired torque can be preset on the dial beforehand and then the bolt can be tightened until the pointer shows "0".

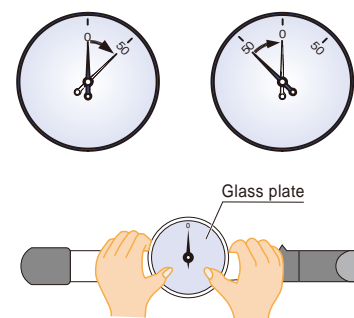

Torque Conversion List

kgf · cm **N · m** 1 kgf · cm = 0.0980665 N · m
 kgf · m 1 kgf · m = 9.80665 N · m

N · m kgf · cm 1 N · m = 10.1972 kgf · cm
 kgf · m 1 N · m = 0.101972 kgf · m

Technical Data

kgf·cm	N·m									
	0	1	2	3	4	5	6	7	8	9
10	0.981	1.08	1.18	1.27	1.37	1.47	1.57	1.67	1.77	1.86
20	1.96	2.06	2.16	2.26	2.35	2.45	2.55	2.65	2.75	2.84
30	2.94	3.04	3.14	3.24	3.33	3.43	3.53	3.63	3.73	3.82
40	3.92	4.02	4.12	4.22	4.31	4.41	4.51	4.61	4.71	4.81
50	4.90	5.00	5.10	5.20	5.30	5.39	5.49	5.59	5.69	5.79
60	5.88	5.98	6.08	6.18	6.28	6.37	6.47	6.57	6.67	6.77
70	6.86	6.96	7.06	7.16	7.26	7.35	7.45	7.55	7.65	7.75
80	7.85	7.94	8.04	8.14	8.24	8.34	8.43	8.53	8.63	8.73
90	8.83	8.92	9.02	9.12	9.22	9.32	9.41	9.51	9.61	9.71
100	9.81	9.90	10.0	10.1	10.2	10.3	10.4	10.5	10.6	10.7

N·m	kgf·cm									
	0	0.1	0.2	0.3	0.4	0.5	0.6	0.7	0.8	0.9
1	10.2	11.2	12.2	13.3	14.3	15.3	16.3	17.3	18.4	19.4
2	20.4	21.4	22.4	23.5	24.5	25.5	26.5	27.5	28.6	29.6
3	30.6	31.6	32.6	33.7	34.7	35.7	36.7	37.7	38.7	39.8
4	40.8	41.8	42.8	43.8	44.9	45.9	46.9	47.9	48.9	50.0
5	51.0	52.0	53.0	54.0	55.1	56.1	57.1	58.1	59.1	60.2
6	61.2	62.2	63.2	64.2	65.3	66.3	67.3	68.3	69.3	70.4
7	71.4	72.4	73.4	74.4	75.5	76.5	77.5	78.5	79.5	80.6
8	81.6	82.6	83.6	84.6	85.7	86.7	87.7	88.7	89.7	90.8
9	91.8	92.8	93.8	94.8	95.9	96.9	97.9	98.9	99.9	101
10	102	103	104	105	106	107	108	109	110	111

kgf·cm	N·m									
	0	10	20	30	40	50	60	70	80	90
100	9.81	10.8	11.8	12.7	13.7	14.7	15.7	16.7	17.7	18.6
200	19.6	20.6	21.6	22.6	23.5	24.5	25.5	26.5	27.5	28.4
300	29.4	30.4	31.4	32.4	33.3	34.3	35.3	36.3	37.3	38.2
400	39.2	40.2	41.2	42.2	43.1	44.1	45.1	46.1	47.1	48.1
500	49.0	50.0	51.0	52.0	53.0	53.9	54.9	55.9	56.9	57.9
600	58.8	59.8	60.8	61.8	62.8	63.7	64.7	65.7	66.7	67.7
700	68.6	69.6	70.6	71.6	72.6	73.5	74.5	75.5	76.5	77.5
800	78.5	79.4	80.4	81.4	82.4	83.4	84.3	85.3	86.3	87.3
900	88.3	89.2	90.2	91.2	92.2	93.2	94.1	95.1	96.1	97.1
1000	98.1	99.0	100	101	102	103	104	105	106	107

N·m	kgf·m									
	0	1	2	3	4	5	6	7	8	9
10	1.02	1.12	1.22	1.33	1.43	1.53	1.63	1.73	1.84	1.94
20	2.04	2.14	2.24	2.35	2.45	2.55	2.65	2.75	2.86	2.96
30	3.06	3.16	3.26	3.37	3.47	3.57	3.67	3.77	3.87	3.98
40	4.08	4.18	4.28	4.38	4.49	4.59	4.69	4.79	4.89	5.00
50	5.10	5.20	5.30	5.40	5.51	5.61	5.71	5.81	5.91	6.02
60	6.12	6.22	6.32	6.42	6.53	6.63	6.73	6.83	6.93	7.04
70	7.14	7.24	7.34	7.44	7.55	7.65	7.75	7.85	7.95	8.06
80	8.16	8.26	8.36	8.46	8.57	8.67	8.77	8.87	8.97	9.08
90	9.18	9.28	9.38	9.48	9.59	9.69	9.79	9.89	9.99	10.1
100	10.2	10.3	10.4	10.5	10.6	10.7	10.8	10.9	11.0	11.1

kgf·m	N·m									
	0	1	2	3	4	5	6	7	8	9
10	98.1	108	118	127	137	147	157	167	177	186
20	196	206	216	226	235	245	255	265	275	284
30	294	304	314	324	333	343	353	363	373	382
40	392	402	412	422	431	441	451	461	471	481
50	490	500	510	520	530	539	549	559	569	579
60	588	598	608	618	628	637	647	657	667	677
70	686	696	706	716	726	735	745	755	765	775
80	785	794	804	814	824	834	843	853	863	873
90	883	892	902	912	922	932	941	951	961	971
100	981	990	1000	1010	1020	1030	1040	1050	1060	1070

N·m	kgf·m									
	0	10	20	30	40	50	60	70	80	90
100	10.2	11.2	12.2	13.3	14.3	15.3	16.3	17.3	18.4	19.4
200	20.4	21.4	22.4	23.5	24.5	25.5	26.5	27.5	28.6	29.6
300	30.6	31.6	32.6	33.7	34.7	35.7	36.7	37.7	38.7	39.8
400	40.8	41.8	42.8	43.8	44.9	45.9	46.9	47.9	48.9	50.0
500	51.0	52.0	53.0	54.0	55.1	56.1	57.1	58.1	59.1	60.2
600	61.2	62.2	63.2	64.2	65.3	66.3	67.3	68.3	69.3	70.4
700	71.4	72.4	73.4	74.4	75.5	76.5	77.5	78.5	79.5	80.6
800	81.6	82.6	83.6	84.6	85.7	86.7	87.7	88.7	89.7	90.8
900	91.8	92.8	93.8	94.8	95.9	96.9	97.9	98.9	99.9	101
1000	102	103	104	105	106	107	108	109	110	111

■ Unit of Torque and Conversion Values

	S.I. unit system			Metric unit system			American unit system		
	mN·m	cN·m	N·m	gf·cm	kgf·cm	kgf·m	ozf·in	lbf·in	lbf·ft
1 mN·m =	1	0.10	0.001	10.2	0.0102	0.000102	0.142	0.00885	0.000738
1 cN·m =	10	1	0.01	102	0.102	0.00102	1.42	0.0885	0.00738
1 N·m =	1000	100	1	10200	10.2	0.102	142	8.85	0.738
1 gf·cm =	0.0981	0.00981	0.0000981	1	0.001	0.00001	0.0139	0.000868	0.0000723
1 kgf·cm =	98.1	9.81	0.0981	1000	1	0.01	13.9	0.868	0.0723
1 kgf·m =	9810	981	9.81	100000	100	1	1390	86.8	7.23
1 ozf·in =	7.06	0.706	0.00706	72.0	0.072	0.00072	1	0.0625	0.00521
1 lbf·in =	113	11.3	0.113	1150	1.15	0.0115	16	1	0.0833
1 lbf·ft =	1360	136	1.36	13800	13.8	0.138	192	12	1
Country/Region	Japan, China, Europe			Asia			U.S.A., Aircraft industry		

1 [N·m] = 10.1972 [kgf·cm] ≈ 10.20 [kgf·cm] 1 [kgf·cm] = 0.0980665 [N·m] ≈ 0.0981 [N·m]

Conversion example: T = 25·0 [kgf·cm] = 25.0 × 0.0980665 = 2.4516625 [N·m] ≈ 2.45 [N·m]

■ JCSS/Japan Calibration Service System

Tohnichi Mfg. Co. Ltd's torque standards calibration laboratory is now an authorized calibration service provider of JCSS/Japan Calibration Service System under Japanese measurement law. Registration number: JCSS0281
 Based on this, Tohnichi has launched a JCSS calibration service for DOTE4-G torque wrench testers from 10 N·m to 1000 N·m and CEM3 digital torque wrenches as a validated JCSS system and an uncertainty certificate service for outside of the above stated torque range.

Tohnichi issued JCSS calibration certificate is recognized internationally based on MRA/Mutual Recognition Arrangement of ILAC/International Laboratory Accreditation Cooperation and APLAC/Asia Pacific Laboratory Accreditation Cooperation by IAJapan/International Accreditation Japan.

Standard Tightening Torque

Standard Tightening Torque [N·m]		Reference value		
Nominal diameter	T [N·m]	0.5T series [N·m]	1.8T series [N·m]	2.4T series [N·m]
M1	0.0195	0.0098	0.035	0.047
(M1.1)	0.027	0.0135	0.049	0.065
M1.2	0.037	0.0185	0.066	0.088
(M1.4)	0.058	0.029	0.104	0.140
M1.6	0.086	0.043	0.156	0.206
(M1.8)	0.128	0.064	0.23	0.305
M2	0.176	0.088	0.315	0.42
(M2.2)	0.23	0.116	0.41	0.55
M2.5	0.36	0.18	0.65	0.86
M3	0.63	0.315	1.14	1.50
(M3.5)	1	0.5	1.8	2.40
M4	1.5	0.75	2.7	3.6
(M4.5)	2.15	1.08	3.9	5.2
M5	3	1.5	5.4	7.2
M6	5.2	2.6	9.2	12.2
(M7)	8.4	4.2	15	20.0
M8	12.5	6.2	22	29.5
M10	24.5	12.5	44	59
M12	42	21	76	100
(M14)	68	34	122	166
M16	106	53	190	255
M18	146	73	270	350
M20	204	102	370	490
(M22)	282	140	500	670
M24	360	180	650	860
(M27)	520	260	940	1240
M30	700	350	1260	1700
(M33)	960	480	1750	2300
M36	1240	620	2250	3000
(M39)	1600	800	2900	3800
M42	2000	1000	3600	4800
(M45)	2500	1260	4500	6000
M48	2950	1500	5300	7000
(M52)	3800	1900	6800	9200
M56	4800	2400	8600	11600
(M60)	5900	2950	10600	14000
M64	7200	3600	13000	17500
(M68)	8800	4400	16000	21000

Standard bolt stress: 210 [N/mm²] Stress of bolt (JIS B1082)

Standard Tightening Torque [kgf·cm]		Reference value		
Nominal diameter	T [kgf·cm]	0.5T series [kgf·cm]	1.8T series [kgf·cm]	2.4T series [kgf·cm]
M1	0.199	0.100	0.357	0.479
(M1.1)	0.275	0.138	0.500	0.663
M1.2	0.377	0.189	0.673	0.897
(M1.4)	0.591	0.296	1.06	1.43
M1.6	0.877	0.438	1.59	2.10
(M1.8)	1.31	0.653	2.35	3.11
M2	1.79	0.897	3.21	4.28
(M2.2)	2.35	1.17	4.18	5.61
M2.5	3.67	1.84	6.63	8.77
M3	6.42	3.21	11.6	15.3
(M3.5)	10.2	5.1	18.4	24.5
M4	15.3	7.6	27.5	36.7
(M4.5)	21.9	11.0	39.8	53.0
M5	29.4	14.7	53.0	70.6
M6	53.0	26.5	93.8	124
(M7)	85.7	42.8	153	204
M8	127	63.2	224	301
M10	250	127	449	602
M12	428	214	775	1020
(M14)	693	347	1240	1690
M16	1080	540	1940	2600
M18	1490	744	2750	3570
M20	2080	1040	3770	5000
(M22)	2880	1430	5100	6830
M24	3670	1840	6630	8770
(M27)	5300	2650	9590	12600
M30	7140	3570	12800	17300
(M33)	9790	4890	17800	23500
M36	12600	6320	22900	30600
(M39)	16300	8160	29600	38700
M42	20400	10200	36700	48900
(M45)	25500	12800	45900	61200
M48	30100	15300	54000	71400
(M52)	38700	19400	69300	93800
M56	48900	24500	87700	118000
(M60)	60200	30100	108000	143000
M64	73400	36700	133000	178000
(M68)	89700	44900	163000	214000

Notes: Conversion values rolled up to effective 3-digits.

■ Screws and Applicable "T" Series

	Standard T series	0.5T series	1.8T series	2.4T series
Applicable screws (Strengths) (Material)	4.6-6.8 SS, SC, SUS	- Brass, Copper, Aluminum	8.8-12.9 SCr, SNC, SCM	10.9-12.9 SCr, SNC, SCM, SNCM
Axial tension standard value [N/mm ²] Min - Max	210 300-160	105 150-80	380 540-290	500 710-380
Application	To be applied to ordinary screws, unless otherwise specified	Male and female screws with copper, aluminum or plastic, for die-cast plastic products	Durable screw joints made of special steel including those affected by additional dynamic loads (Friction clamping)	
Applicable products	Ordinary products	Electronic products	Vehicles, Engines	Construction products

* The maximum to the minimum of the axial stress is considered as the dispersion of the torque coefficient.

Example: max = 210 × (0.2/0.14) = 300 [N/mm²]

Torque coefficient: 0.14/Min. - 0.2/Avg. - 0.26/Max.

■ Calibration Certificate ■

- Torque wrenches are measuring instruments. The calibration certificate is the document which certifies the accuracy of the torque products, which are traceable to Japanese national standards. Please keep the calibration certificate for future use.
- Accuracy % is calculated on each indicated value. Accuracy stated as "+/- a percentage + 1 digit" indicates that digital display will round up to next digit in resolution if value falls between digits.
- Tohnichi's torque products provided with a calibration certificate can be used immediately at ISO9000 facilities without the need for further acceptance inspection or any additional certifications.
- The calibration certificate is effective for 1 year from the date of first use within 3 years from the date of inspection. Please fill in the date in the calibration certificate when first used.
- Tohnichi's manual torque tools are normally guaranteed to 100,000 tightening cycles or 1 year. For click type torque wrenches, it can be also used up to 1,000,000 tightening cycles if the function is properly maintained and adjusted at every 100,000 cycles.

■ RoHS/Restriction of Hazardous Substances Directive ■

Following RoHS, which restricts the use of certain hazardous materials in product manufacturing, Tohnichi has expanded its efforts in environmentally friendly procurement. Starting with our Product Catalog 2011 edition, the **RoHS** mark is shown on all applicable models conforming to the RoHS directive. For details, please contact Tohnichi.



2022

Reference Guide



The latest information is available on
global Tohnichi site.

<https://www.global-tohnichi.com>



The TUD symbol indicates that our products are ergonomically designed and adapted for Color Vision Deficiencies.

- Designs and specifications are subject to change without notice.
- All rights reserved. No reproduction or republication without written permission.
- Tohnichi Mfg. Co., Ltd. All Rights Reserved.