

BIX

ひらめき! きらめき! 確かな技術!!

Bits & Sockets

Product Catalogue



No. 5

特長

徹底した品質管理

JIS規格及びJCIS規格などにもとづき、厳しい寸法精度で製作し、ねじとの嵌合は抜群です。

また、加工から熱処理まで社内一貫生産により製作しておりますので、品質管理は徹底しており、均一な品質の商品を提供いたします。

すぐれた耐久性

材料は、特殊合金鋼を使用し、材質に合った熱処理を入念に行なっておりますので、すぐれた耐久性を発揮いたします。用途に合った硬度の選定により、最高の耐久性が得られます。

H(軽荷重用) ビットの硬度は高く、比較的弱いトルクでの締め付け作業に適しています。
〈電動ドライバー・クラッチ機構ドライバー〉

G(中荷重用) ビットの硬度はやや高く、一般的なトルクでの締め付け作業に適しています。
〈電動ドライバー・クラッチ機構ドライバー〉

E(中荷重用) ビットの硬度は普通で、一般的なトルクでの締め付け作業に適しています。
〈インパクト機構ドライバー〉

F(重荷重用) ビットの硬度は低く、衝撃力の強い締め付け作業に適しています。
〈インパクト機構エアードライバー〉

豊富な種類

エアードライバー、電動ドライバー等の国内及び外国メーカーの多様な機種に適合する豊富な種類とサイズに対応いたします。また特殊品の製作にも応じますのでご相談ください。

Features

Thorough Quality Control

Our tools are crafted with strict dimensional accuracy based on JIS and JCIS standards, engaging the screws superbly. All production from machining to heat-treating is done in-house, which means thorough quality control for providing products with predictable quality.

Superior Durability

We use special alloy steels for our materials, and provide thorough heat-treatment matching each material. This yields superior durability. You can expect maximum durability by selecting the appropriate hardness for your intended use.

H (light load) : High bit hardness, appropriate for tightening operations with comparatively low torque requirements.

(Electric drivers, clutch type drives)

G (medium load) : Somewhat high bit hardness, appropriate for tightening operations with general torque requirements.

(Electric drivers, clutch type drives)

E (medium load) : Normal bit hardness, appropriate for tightening operations with general torque requirements.

(Impact type drivers)

F (heavy load) : Low bit hardness, appropriate for tightening operations with high impact.
(Impact type air drivers)

Abundant Variety

Our products are compatible with an abundant variety of air driver and electric driver models from Japanese and international manufacturers. Please inquire about our tailor-made products as well.

目次

INDEX

Standard chart	—	2
<small>規格表</small>		
Small electric driver bits	—	4
<small>小型電動ドライバー用ビット</small>		
Small electric driver bits(Hex lobe)	—	10
<small>小型電動ドライバー用ビット(ヘックスローブ)</small>		
Small electric driver socket bits	—	11
<small>小型電動ドライバー用ソケットビット</small>		
Driver bits	—	14
<small>ドライバービット</small>		
Driver bits(Hex lobe)	—	24
<small>ドライバービット(ヘックスローブ)</small>		
Screw tightening robot bits	—	27
<small>ネジ締め用ロボットビット</small>		
Socket bits	—	28
<small>ソケットビット</small>		
Universal socket bits	—	32
<small>ユニバーサルソケットビット</small>		
Socket bits with Magnet	—	32
<small>Mg入りソケットビット</small>		
Special parts socket bits	—	35
<small>ソケットビット スペシャルパーツ</small>		
Impact sockets	—	36
<small>インパクトソケット</small>		
Impact sockets with Magnet	—	46
<small>Mg入りインパクトソケット</small>		
Universal impact sockets	—	49
<small>ユニバーサルインパクトソケット</small>		
Adapters・Extension bars	—	50
<small>アダプター・エクステンションバー</small>		
Stamp socket	—	54
<small>スタンプソケット</small>		
Antivibration socket	—	56
<small>防振ソケット</small>		
Antivibration socket extension type	—	58
<small>防振ソケットエクステンションタイプ</small>		
Antivibration socket with magnet	—	59
<small>防振ソケットマグネットタイプ</small>		
Antivibration socket with ring magnet	—	60
<small>防振ソケットリングマグネットタイプ</small>		
Antivibration socket with slide magnet	—	61
<small>防振ソケットスライドマグネットタイプ</small>		
Antivibration universal socket	—	62
<small>防振ユニバーサルソケット</small>		
Antivibration extension bar	—	63
<small>防振エクステンションバー</small>		
Special parts impact socket	—	64
<small>インパクトソケット スペシャルパーツ</small>		

BIX BIX SCREWDRIVER BITS

Japanese Industrial Standards (JIS 4633) 日本工業規格

Cross Point screwdrivers

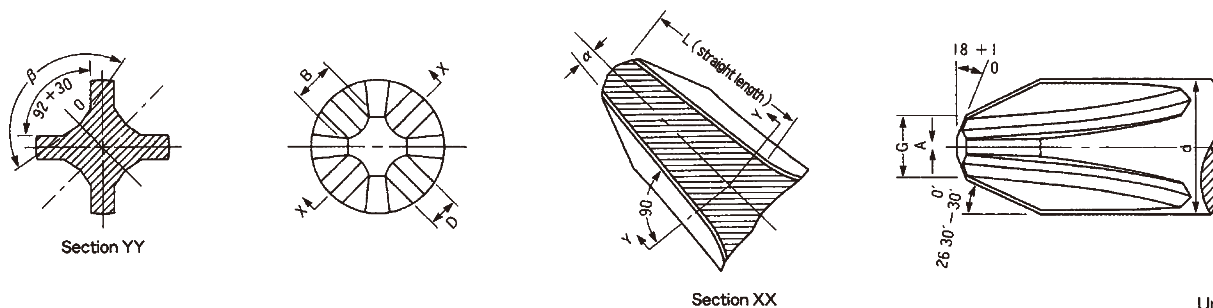

Unit : mm

Nominal Size	d		B		D		G		α		β		L Min
	Standard dimension	Tolerance	Standard dimension	Tolerance	Standard dimension	Tolerance	Standard dimension	Tolerance	Standard dimension	Tolerance	Standard dimension	Tolerance	
No.1	5	+0.4 -0.2	1.001	+0.05 -0.14	0.513	+0.20 -0.10	1.27	+0.15 -0.15	7°	+0 -45'	138°	+45' -0	2.5
No.2	6		1.539	+0.07 -0.15	1.102		2.286		5°45'		140°		3.7
No.3	8		2.497	+0.10 -0.17	2.098	+0.25 -0.15	3.81	+0.20 -0.20	5°45'		146°		5.2
No.4	9		3.574		2.738		5.08		7°		153°		7.6

Japanese Camera Industry Standards (JCIS 9-70) 日本写真機工業規格

Precision Instrument Cross Point Screwdrivers

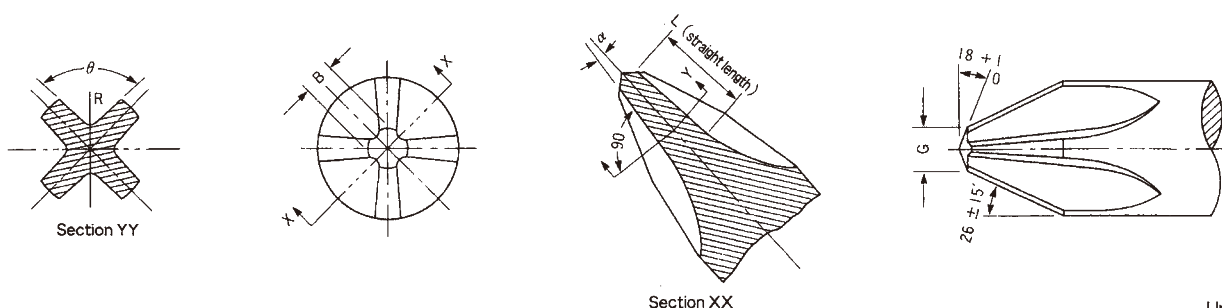



Unit : mm

Type	Cross Point number	B		G		R		α		θ		L
S-type	0	Standard dimension	Tolerance	Standard dimension	Tolerance	Standard dimension	Tolerance	Standard dimension	Tolerance	Standard dimension	Tolerance	Min
		0.49	+0.04 -0.1	0.91	+0.1 -0.1	0.06	+0.06 -0.03	7°	0 -45'	92°	+1° -0	1.5



BIX BIX SCREWDRIVER BITS

ネジの呼び径とねじ規格一覧表



Screws nominal diameter and screws standard chart

			M1	M1.2	M1.4	M1.6	M2	M2.2	M2.5	M3	M3.5	M4	M5	M6	M8	M10
	すりわり付き小ねじ Slotted head screws	JIS B1101				0.4	0.5		0.6	0.8	1	1.2	1.2	1.6	1.8	2.5
	精密機器用すりわり付き小ねじ Slotted head machine screws for precision instruments	JIS B1116	0.32	0.32	0.32	0.32	0.4	0.4	0.6							
	十字穴付き小ねじ Cross recessed head screws	JCIS 10-70			No.0		No.0									
		JIS B1111					No.1	No.1	No.1	*No.2	No.2	No.2	No.2	No.2	No.3	No.3

*トラスねじは No.1 (truss screws is No.1)





			2	2.5	3	3.5	4	4.5	5	6	8
	十字穴付きタッピンねじ Cross recessed head tapping screws	JIS B1122	No.1	No.1	*No.2	No.2	No.2	No.2	No.2	No.3	
	六角タッピンねじ Hexagon head tapping screws	JIS B1123			5	5.5	7	7	8	10	12

*トラスねじは No.1 (truss screws is No.1)

			1.6	1.8	2.1	2.4	2.7	3.1	3.5	3.8	4.1	4.5	4.8	5.1	5.5	5.8	6.2	6.8	7.5	8	9.5
	すりわり付き木ねじ Slotted head wood screws	JIS B1135	0.4	0.6	0.6	0.7	0.8	0.9	1	1	1.2	1.2	1.3	1.4	1.4	1.6	1.6	1.6	1.8	1.8	2
	十字穴付き木ねじ Cross recessed head wood screws	JIS B1112			No.1	No.1	No.1	No.2	No.2	No.2	No.2	No.2	No.2	No.3	No.3	No.3	No.3	No.3	No.4	No.4	No.4

六角ボルト(ナット)の呼び径と2面幅

Hexagon head bolt(nut)nominal diameter width across flats

			M1.6	M2	M2.5	M3	M3.5	M4	M5	M6	M8	M10	M12	(M14)	M16	M20	M24
	六角穴付き止ねじ Hexagon socket set screws	JIS B1177	0.7	0.9	1.3	1.5		2	2.5	3	4	5	6		8	10	12
	六角穴付きボルト Hexagon socket head cap screws	JIS B1176	1.5	1.5	2	2.5		3	4	5	6	8	10		14	17	19
	六角ボルト(小形六角ボルト) Hexagon head bolts (small hexagon head bolts)	JIS B1180	3.2	4	5	5.5	6	7	8	10	13 (12)	16 17 (14)	18 19 (17)	21 22 (19)	24 (22)	30 (27)	36 (32)
	六角ナット(小形六角ナット) hexagon nuts (small hexagon nuts)	JIS B1181		4	5	5.5	6	7	8	10	13 (12)	16 17 (14)	18 19 (17)	21 22 (19)	24 (22)	30 (27)	36 (32)

Small electric driver bits

小型電動ドライバー用ビット

MODEL	BD-4	4mm \odot
-------	-------------	-------------

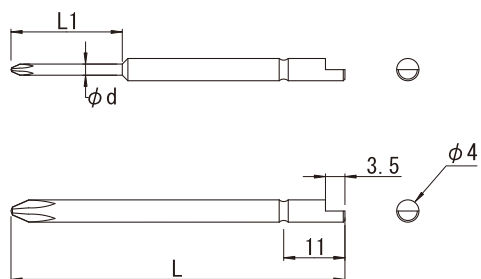

EDP #	POINT SIZE	(d x L1)	Shank diameter	L	
BD4001244	No.00	$\phi 1.2 \times 20$	$\phi 4$	44	
BD4001264		$\phi 1.2 \times 20$		64	
BD4001444		$\phi 1.4 \times 20$		44	
BD4001464		$\phi 1.4 \times 20$		64	
BD4001544		$\phi 1.5 \times 20$		44	
BD4001564		$\phi 1.5 \times 20$		64	
BD4001744		$\phi 1.7 \times 20$		44	
BD4001764		$\phi 1.7 \times 20$		64	
BD4001844		$\ast \phi 1.8 \times 20$		44	
BD4001864		$\ast \phi 1.8 \times 20$		64	
BD4002044		$\phi 2.0 \times 20$		44	
BD4002064		$\phi 2.0 \times 20$		64	
BD401444		No.0		$\phi 1.4 \times 20$	44
BD401464				$\phi 1.4 \times 20$	64
BD401544	$\phi 1.5 \times 20$			44	
BD401564	$\phi 1.5 \times 20$			64	
BD401744	$\phi 1.7 \times 20$			44	
BD401764	$\phi 1.7 \times 20$			64	
BD401844	$\ast \phi 1.8 \times 20$			44	
BD401864	$\ast \phi 1.8 \times 20$			64	
BD402044	$\phi 2.0 \times 20$			44	
BD402064	$\phi 2.0 \times 20$			64	
BD402344	$\ast \phi 2.3 \times 20$			44	
BD402364	$\ast \phi 2.3 \times 20$			64	
BD402544	$\phi 2.5 \times 20$			44	
BD402564	$\phi 2.5 \times 20$			64	
BD403044	$\phi 3.0 \times 20$			44	
BD403064	$\phi 3.0 \times 20$			64	
BD404044	$\phi 4.0$		44		
BD404064	$\phi 4.0$		64		
BD412544	No.1	$\phi 2.5 \times 20$	44		
BD412564		$\phi 2.5 \times 20$	64		
BD413044		$\phi 3.0 \times 20$	44		
BD413064		$\phi 3.0 \times 20$	64		
BD414044		$\phi 4.0$	44		
BD414064		$\phi 4.0$	64		
BD424044	No.2	$\phi 4.0$	44		
BD424064		$\phi 4.0$	64		

(No.00 follows our in-house standards)
(No.00については当社規格です。)

\ast shows non-standard products
 \ast 印は標準品です。
 \ast We can also manufacture products longer than 80mm total length.
 \ast 全長80mm以上についても製作致します

Small electric driver bits

BiX

小型電動ドライバー用ビット

小型電動ドライバービット

MODEL **BD-4M** 4mm

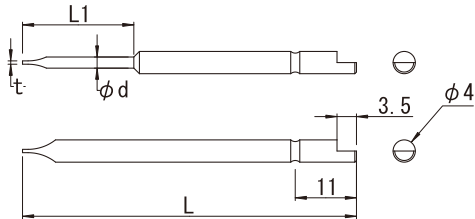

EDP #	POINT SIZE	(d × L1)	Shank diameter	L
BD4M2044	-0.4t×2.0	φ2.0×20	φ4	44
BD4M2064		φ2.0×20		64
BD4M2544	-0.4t×2.5	φ2.5×20		44
BD4M2564		φ2.5×20		64
BD4M3044	-0.4t×3.0	φ3.0×20		44
BD4M3064		φ3.0×20		64
BD4M4044	-0.6t×4.0	φ4.0		44
BD4M4064		φ4.0		64

MODEL **BD-4X** 4mm

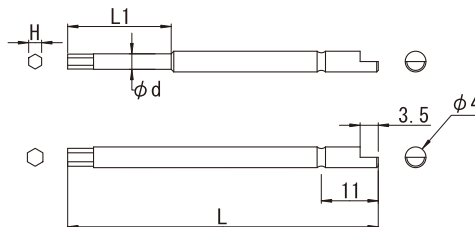

EDP #	POINT SIZE	(d × L1)	Shank diameter	L
BD4X1544	H1.5	φ3.0×20	φ4	44
BD4X1564		φ3.0×20		64
BD4X2044	H2.0	φ3.0×20		44
BD4X2064		φ3.0×20		64
BD4X2544	H2.5	φ3.0×20		44
BD4X2564		φ3.0×20		64
BD4X3044	H3	φ4.0		44
BD4X3064		φ4.0		64
BD4X4044	H4	φ5.0		※44
BD4X4064		φ5.0		※64

※shows non-standard products

※印は標準品です。

※We can also manufacture products longer than 80mm total length.

※全長80mm以上についても製作致します

MODEL **BH-4V** 4mm

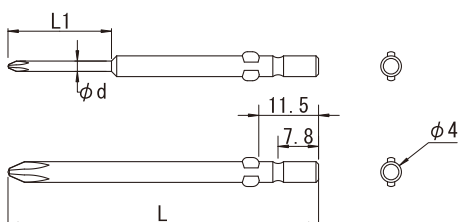

EDP #	POINT SIZE	(d × L1)	Shank diameter	L
B4V001240	No.00	φ1.2×20	φ4	40
B4V001260		φ1.2×20		60
B4V001540		φ1.5×20		40
B4V001560		φ1.5×20		60
B4V001740		φ1.7×20		40
B4V001760		φ1.7×20		60
B4V002040		φ2.0×20		40
B4V002060		φ2.0×20		60
B4V002080		φ2.0×20		80
B4V002080-3		φ2.0×30		80
B4V01440	No.0	φ1.4×20	φ4	40
B4V01460		φ1.4×20		60
B4V01480		φ1.4×20		80
B4V014100		φ1.4×20		100
B4V01480-3		φ1.4×30		80
B4V014100-3		φ1.4×30		100

Small electric driver bits

小型電動ドライバー用ビット

MODEL **BH-4V** 4mm

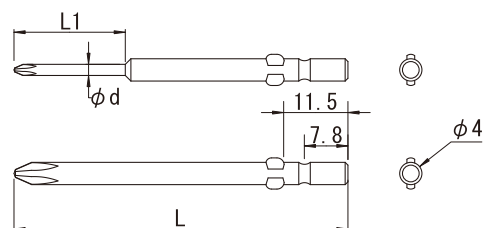

EDP #	POINT SIZE	(d × L1)	Shank diameter	L	
B4V01540	No.0	φ 1.5×20	φ 4	40	
B4V01560		φ 1.5×20		60	
B4V01740		φ 1.7×20		40	
B4V01760		φ 1.7×20		60	
B4V01780		φ 1.7×20		80	
B4V01780-3		φ 1.7×30		80	
B4V02040		φ 2.0×20		40	
B4V02060		φ 2.0×20		60	
B4V02080		φ 2.0×20		80	
B4V020100		φ 2.0×20		100	
B4V02080-3		φ 2.0×30		80	
B4V020100-3		φ 2.0×30		100	
B4V02340		※ φ 2.3×20		40	
B4V02360		※ φ 2.3×20		60	
B4V02540		φ 2.5×20		40	
B4V02560		φ 2.5×20		60	
B4V02580		φ 2.5×20		80	
B4V025100		φ 2.5×20		100	
B4V02580-3		φ 2.5×30		80	
B4V025100-3		φ 2.5×30		100	
B4V03040		φ 3.0×20		40	
B4V03060		φ 3.0×20		60	
B4V03080		φ 3.0×20		80	
B4V030100		φ 3.0×20		100	
B4V03080-3		φ 3.0×30		80	
B4V030100-3		φ 3.0×30		100	
B4V04040		φ 4.0		40	
B4V04060		φ 4.0		60	
B4V12040		No.1		φ 2.0×20	40
B4V12060				φ 2.0×20	60
B4V12540				φ 2.5×20	40
B4V12560				φ 2.5×20	60
B4V12580				φ 2.5×20	80
B4V125100				φ 2.5×20	100
B4V12580-3				φ 2.5×30	80
B4V125100-3				φ 2.5×30	100
B4V13040				φ 3.0×20	40
B4V13060				φ 3.0×20	60
B4V13080				φ 3.0×20	80
B4V130100				φ 3.0×20	100
B4V13080-3	φ 3.0×30		80		
B4V130100-3	φ 3.0×30		100		
B4V14040	φ 4.0		40		
B4V14060	φ 4.0		60		
B4V14080	φ 4.0		80		
B4V140100	φ 4.0		100		
B4V140120	φ 4.0		120		
B4V24040	No.2		φ 4.0	40	
B4V24060		φ 4.0	60		
B4V24080		φ 4.0	80		
B4V240100		φ 4.0	100		
B4V240120		φ 4.0	120		

(No.00 follows our in-house standards)
(No.00については当社規格です。)

※shows non-standard products
※印は準標準品です。

※We can also manufacture products longer than 80mm total length.

※全長80mm以上についても製作致します

Small electric driver bits

BiX

小型電動ドライバー用ビット

小型電動ドライバー用ビット

MODEL **BH-4VM** 4mm

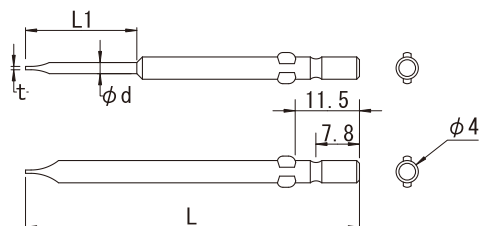

EDP #	POINT SIZE	(d × L1)	Shank diameter	L
B4VM1140	-0.28t×1.1	φ 1.1×20	φ 4	40
B4VM1160		φ 1.1×20		60
B4VM1340	-0.28t×1.3	φ 1.3×20		40
B4VM1360		φ 1.3×20		60
B4VM1540	-0.3t×1.5	φ 1.5×20		40
B4VM1560		φ 1.5×20		60
B4VM1740	-0.3t×1.7	φ 1.7×20		40
B4VM1760		φ 1.7×20		60
B4VM2040	-0.4t×2.0	φ 2.0×20		40
B4VM2060		φ 2.0×20		60
B4VM2080		φ 2.0×20		80
B4VM2340	-0.4t×2.3	φ 2.3×20		40
B4VM2360		φ 2.3×20		60
B4VM2540	-0.4t×2.5	φ 2.5×20		40
B4VM2560		φ 2.5×20		60
B4VM2580		φ 2.5×20		80
B4VM3040	-0.4t×3.0	φ 3.0×20	40	
B4VM3060		φ 3.0×20	60	
B4VM3080		φ 3.0×20	80	
B4VM4040	-0.6t×4.0	φ 4.0	40	
B4VM4060		φ 4.0	60	
B4VM4080		φ 4.0	80	

MODEL **BH-4VX** 4mm

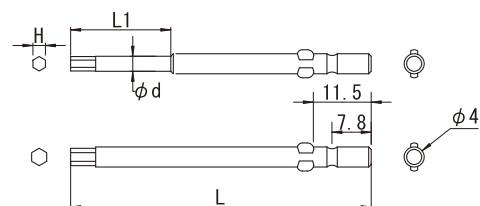

EDP #	POINT SIZE	(d × L1)	Shank diameter	L
B4VX1540	H1.5	φ 3.0×20	φ 4	40
B4VX1560		φ 3.0×20		60
B4VX2040	H2.0	φ 3.0×20		40
B4VX2060		φ 3.0×20		60
B4VX2540	H2.5	φ 3.0×20		40
B4VX2560		φ 3.0×20		60
B4VX3040	H3	φ 4		40
B4VX3060		φ 4		60
B4VX4040	H4	φ 5.0		40
B4VX4060		φ 5.0		60

※shows non-standard products
※印は標準品です。

Small electric driver bits

小型電動ドライバー用ビット

MODEL **BH-5V** 5mm

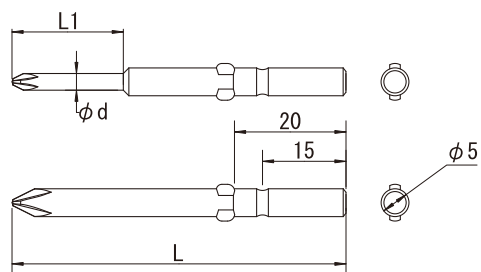

EDP #	POINT SIZE	(d × L1)	Shank diameter	L
B5V02060	No.0	φ2.0×20	φ5	60
B5V02080		φ2.0×20		80
B5V02560		φ2.5×20		60
B5V02580		φ2.5×20		80
B5V03060		φ3.0×20		60
B5V03080		φ3.0×20		80
B5V05060		φ5.0		60
B5V05080		φ5.0		80
B5V13060	No.1	φ3.0×20		60
B5V13080		φ3.0×20		80
B5V13060-3		φ3.0×30		60
B5V13080-3		φ3.0×30		80
B5V15060		φ5.0		60
B5V15080		φ5.0		80
B5V150100	φ5.0	100		
B5V25060	No.2	φ5.0		60
B5V25080		φ5.0	80	
B5V250100		φ5.0	100	
B5V250120		φ5.0	120	

MODEL **BH-5VM** 5mm

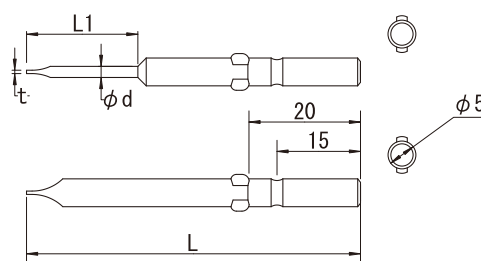

EDP #	POINT SIZE	(d × L1)	Shank diameter	L
B5VM2060	-0.4t×2.0	φ2.0×20	φ5	60
B5VM2080		φ2.0×20		80
B5VM2560	-0.4t×2.5	φ2.5×20		60
B5VM2580		φ2.5×20		80
B5VM3060	-0.4t×3.0	φ3.0×20		60
B5VM3080		φ3.0×20		80
B5VM4060	-0.6t×4.0	φ4.0×20		60
B5VM4080		φ4.0×20		80
B5VM5060	-0.6t×5.0	φ5.0		60
B5VM5080		φ5.0		80

Small electric driver bits

BiX

小型電動ドライバー用ビット

MODEL **BH-5VX** 5mm

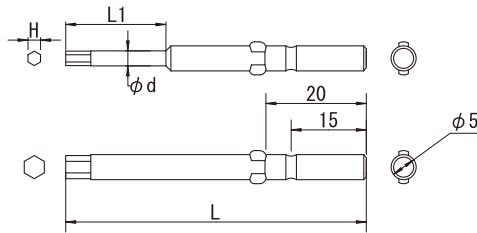

EDP #	POINT SIZE	(d × L1)	Shank diameter	L
B5VX1560	H1.5	φ3.0×20	φ5	60
B5VX1580		φ3.0×20		80
B5VX2060	H2.0	φ3.0×20		60
B5VX2080		φ3.0×20		80
B5VX2560	H2.5	φ3.0×20		60
B5VX2580		φ3.0×20		80
B5VX3060	H3	φ4.0×20		60
B5VX3080		φ4.0×20		80
B5VX4060	H4	φ5		60
B5VX4080		φ5		80
B5VX5060	H5	φ6.0	※60	
B5VX5080		φ6.0	※80	

※shows non-standard products

※印は準標準品です。

※We can also manufacture products longer than 80mm total length.

※全長80mm以上についても製作致します

小型電動ドライバービット

Small electric driver bits(Hex lobe)

小型電動ドライバー用ビット「ヘックスローブ」

MODEL **BD-4T** 4mm

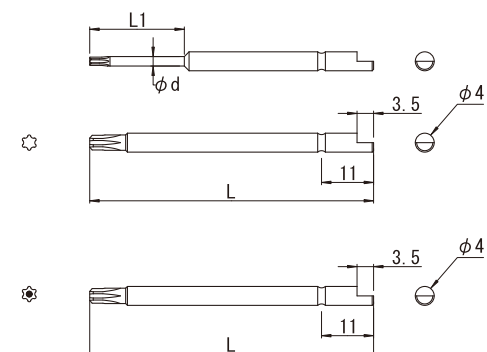

Tamper resistant (H)
いじり止め付き (H)

EDP #	POINT SIZE	(d × L1)	Shank diameter	L
BD4T144	T1 (0.85)	φ 1.3×15	φ 4	44
BD4T164		φ 1.3×15		64
BD4T244	T2 (0.94)	φ 1.5×15		44
BD4T264		φ 1.5×15		64
BD4T344	T3 (1.13)	φ 1.7×20		44
BD4T364		φ 1.7×20		64
BD4T444	T4 (1.30)	φ 1.8×20		44
BD4T464		φ 1.8×20		64
BD4T544	T5 (1.40)	φ 2.0×20		44
BD4T564		φ 2.0×20		64
BD4T644	T6 (1.68)	φ 2.0×20		44
BD4T664		φ 2.0×20		64
BD4T844	T8 (2.29)	φ 2.5×20		44
BD4T864		φ 2.5×20		64
BD4T1044	T10 (2.72)	φ 3.0×20		44
BD4T1064		φ 3.0×20		64
BD4T1544	T15 (3.25)	φ 4.0		44
BD4T1564		φ 4.0		64
BD4T8H44	T8H (2.29)	φ 2.5×20		44
BD4T8H64		φ 2.5×20		64
BD4T10H44	T10H (2.72)	φ 3.0×20		44
BD4T10H64		φ 3.0×20		64
BD4T15H44	T15H (3.25)	φ 4.0		44
BD4T15H64		φ 4.0		64

MODEL **BH-4VT** 4mm

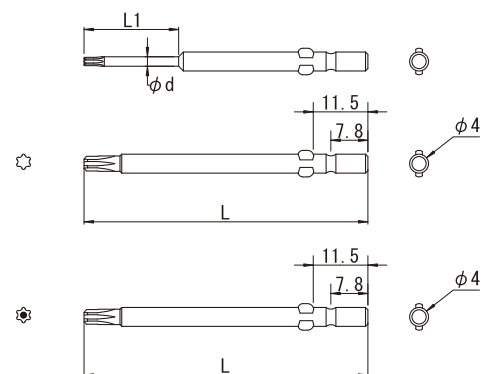

Tamper resistant (H)
いじり止め付き (H)

EDP #	POINT SIZE	(d × L1)	Shank diameter	L
B4VT140	T1 (0.85)	φ 1.3×15	φ 4	40
B4VT160		φ 1.3×15		60
B4VT240	T2 (0.94)	φ 1.5×15		40
B4VT260		φ 1.5×15		60
B4VT340	T3 (1.13)	φ 1.7×20		40
B4VT360		φ 1.7×20		60
B4VT440	T4 (1.30)	φ 1.8×20		40
B4VT460		φ 1.8×20		60
B4VT540	T5 (1.40)	φ 2.0×20		40
B4VT560		φ 2.0×20		60
B4VT640	T6 (1.68)	φ 2.0×20		40
B4VT660		φ 2.0×20		60
B4VT840	T8 (2.29)	φ 2.5×20		40
B4VT860		φ 2.5×20		60
B4VT1040	T10 (2.72)	φ 3.0×20		40
B4VT1060		φ 3.0×20		60
B4VT1540	T15 (3.25)	φ 4.0		40
B4VT1560		φ 4.0		60
B4VT8H40	T8H (2.29)	φ 2.5×20		40
B4VT8H60		φ 2.5×20		60
B4VT10H40	T10H (2.72)	φ 3.0×20		40
B4VT10H60		φ 3.0×20		60
B4VT15H40	T15H (3.25)	φ 4.0		40
B4VT15H60		φ 4.0		60

Small electric driver bits(Hex lobe)

BiX

小型電動ドライバー用ビット「ヘックスローブ」

小型電動ドライバービット

MODEL **BH-5VT** 5mm

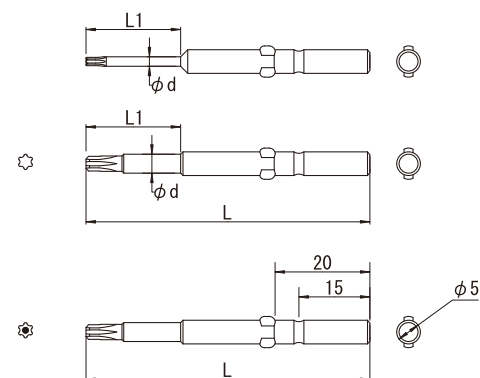

Tamper resistant (H)
いじり止め付き (H)

EDP #	POINT SIZE	(d × L1)	Shank diameter	L
B5VT560	T5 (1.40)	φ2.0×20	φ5	60
B5VT580		φ2.0×20		80
B5VT660	T6 (1.68)	φ2.5×20		60
B5VT680		φ2.5×20		80
B5VT860	T8 (2.29)	φ3.0×20		60
B5VT880		φ3.0×20		80
B5VT1060	T10 (2.72)	φ3.0×20		60
B5VT1080		φ3.0×20		80
B5VT1560	T15 (3.25)	φ4.0×20		60
B5VT1580		φ4.0×20		80
B5VT8H60	T8H (2.29)	φ3.0×20		60
B5VT8H80		φ3.0×20		80
B5VT10H60	T10H (2.72)	φ3.0×20	60	
B5VT10H80		φ3.0×20	80	
B5VT15H60	T15H (3.25)	φ4.0×20	60	
B5VT15H80		φ4.0×20	80	

※We can also manufacture products longer than 80mm total length.
※全長80mm以上についても製作致します

Small electric driver socket bits

小型電動ドライバー用ソケットビット

MODEL **BD-4B** 4mm

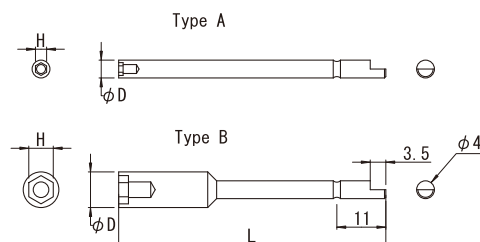
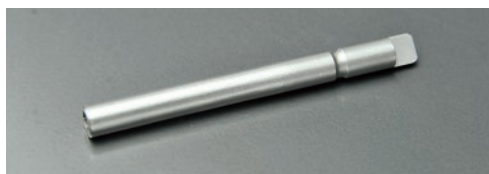

EDP #	Hex opening(H)	O/D	L	Type
4DB2344	2.3	4	44	A
4DB2364	2.3	4	64	A
4DB2544	2.5	4	44	A
4DB2564	2.5	4	64	A
4DB0344	3	5	44	B
4DB0364	3	5	64	B
4DB0444	4	6	44	B
4DB0464	4	6	64	B
4DB4544	4.5	7	44	B
4DB4564	4.5	7	64	B
4DB0544	5	7	44	B
4DB0564	5	7	64	B
4DB5544	5.5	8	44	B
4DB5564	5.5	8	64	B

Small electric driver socket bits

小型電動ドライバー用ソケットビット

MODEL **BD-4BM** 4mm

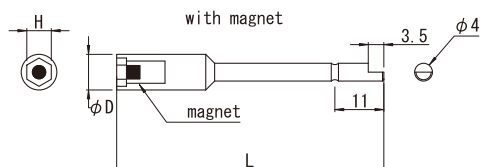

EDP #	Hex opening(H)	O/D	L	Type
4DBM0464	4	6	64	With Mg
4DBM0564	5	7	64	With Mg
4DBM5564	5.5	8	64	With Mg

MODEL **BH-4VB** 4mm

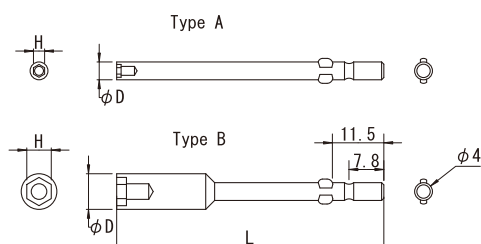

EDP #	Hex opening(H)	O/D	L	Type
4VB2340	2.3	4	40	A(phi 4)
4VB2540	2.5	4	40	A(phi 4)
4VB0360	3	5	60	B(phi 4)
4VB0460	4	6	60	B(phi 4)
4VB4560	4.5	7	60	B(phi 4)
4VB0560	5	7	60	B(phi 4)
4VB5560	5.5	8	60	B(phi 4)

MODEL **BH-4VBM** 4mm

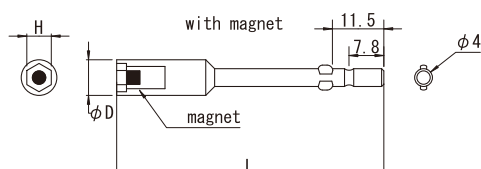

EDP #	Hex opening(H)	O/D	L	Type
4VBM0460	4	6	60	With Mg
4VBM0560	5	7	60	With Mg
4VBM5560	5.5	8	60	With Mg

Small electric driver socket bits

BiX

小型電動ドライバー用ソケットビット

小型電動ドライバービット

MODEL **BH-5VB** 5mm



Type B

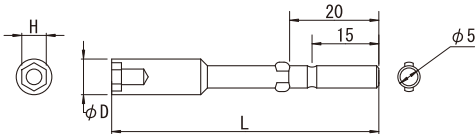

EDP #	Hex opening(H)	O/D	L	Type
5VB0460	4	7	60	B($\phi 5$)
5VB4560	4.5	7	60	B($\phi 5$)
5VB0560	5	8	60	B($\phi 5$)
5VB5560	5.5	9	60	B($\phi 5$)
5VB0660	6	10	60	B($\phi 5$)
5VB0760	7	11	60	B($\phi 5$)

MODEL **BH-5VBM** 5mm

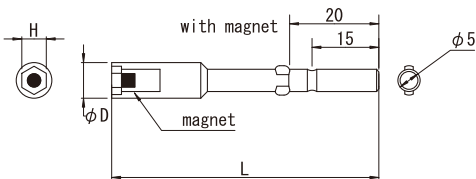

EDP #	Hex opening(H)	O/D	L	Type
5VBM0460	4	7	60	With Mg
5VBM0560	5	8	60	With Mg
5VBM5560	5.5	9	60	With Mg
5VBM0660	6	10	60	With Mg
5VBM0760	7	11	60	With Mg

※We can also manufacture tailor-made products based on your drawings and samples.

※図面、サンプル等により特殊品の製作も承ります。