

QFP lead hook/Chip shear jig for solder joint strength test SJ series

- Designed to measure tensile strength and shear strength of solder joint
- Complies with the corresponding part of IEC and JIS standards
- Chip shear jig: 4 types of tip width available



SJ-QFP-01



SJ-TIP-01



SJ-TIP-02





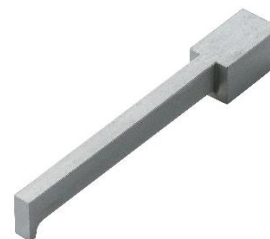

SJ-TIP-03

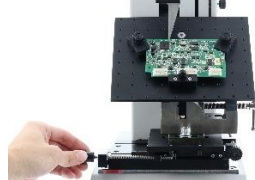

SJ-TIP-04

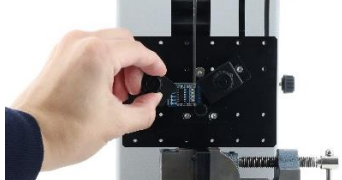

Related Standards	
SJ-QFP-01	<p>-IEC 62137-1-1:2007 Surface mounting technology - Environmental and endurance test methods for surface mount solder joint - Part 1-1: Pull strength test (Corresponding part only) (Japanese Standards: JIS C 62137-1-1: 2010) (Corresponding part only)</p> <p>-JIS Z 3198-6: 2003 Test methods for lead-free solders Part 6: Methods for 45°pull test of solder joints on QFP lead (Corresponding part only)</p>
SJ-TIP-01	<p>-JIS C 60068-2-21: 2009 Environmental testing-Part 2-21: Tests-Test U: Robustness of terminations and integral mounting devices (Corresponding part only)</p>
SJ-TIP-02	<p>-JIS Z 3198-7: 2003 Test method for lead-free solders-Part 7: Method for shear strength of solder joints on chip components (Corresponding part only)</p>
SJ-TIP-03/04	<p>-IEC 62137-1-2:2007 Surface mounting technology - Environmental and endurance test methods for surface mount solder joint - Part 1-2: Shear strength test (Corresponding part only) (Japanese Standards: JIS C 62137-1-2: 2010) (Corresponding part only)</p>

How to Install the Test Sample (SJ-QFP-01 and SJS-1000N-L/S)		
Fix sample to the table (SJS-1000N-L/S.)	Adjust the position of hook (SJ-QFP-01) with XY stage.	Hook the soldered part to start testing.
		

How to Install Test Sample (SJ-TIP-03 and SJS-1000N-L/S)		
Fix sample to the table (SJS-1000N-L/S).	Adjust the position of chip shear jig (SJ-TIP-03) with XY stage.	Push the soldered part with the jig to start testing.
		

Specifications					
Use	For 45-degree pull strength test of solder joints	For 90-degree shear strength test of solder joints (tip diameter: 0.25mm)	For 90-degree shear strength test of solder joints (tip diameter: 0.5mm)	For 90-degree shear strength test of solder joints (tip diameter: 2mm)	For 90-degree shear strength test of solder joints (tip diameter: 4mm)
Model	SJ-QFP-01	SJ-TIP-01	SJ-TIP-02	SJ-TIP-03	SJ-TIP-04
Capacity	100N				
Dimensions	Refer to the dimension				
Mounting Screws	M6				
Weight *1	Approx. 60g	Approx.50g	Approx.50g	Approx.15g	Approx. 25g

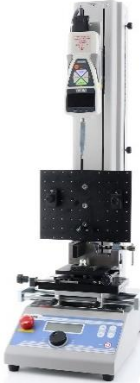
*1 Weight of the attachment is also applied as a load on the force gauge. Consider it when selecting the capacity of a force gauge.

Examples of Product Configuration SJ-QFP-01	
<p>Example 1 Code: 1S2008A IEC 62137-1-1:2007 Surface mounting technology - Environmental and endurance test methods for surface mount solder joint - Part 1-1: Pull strength test (Corresponding part only) (Japanese Standards: JIS C 62137-1-1: 2010) (Corresponding part only) (For large sample)</p> <p>Digital force gauge: ZTS-100N Motorized test stand: EMX-500N-L Optional attachment: SJ-QFP-01 Optional attachment: SJS-100N-L Optional attachment: XST-500N Optional cable: CB-528 Optional software: Force Recorder Standard</p>	 SJ-QFP-01 Example1 Image
Examples of Product Configuration SJ-TIP-02	
<p>Example 1 Code: 1S2009A JIS Z 3198-7: 2003 Test method for lead-free solders-Part 7: Method for shear strength of solder joints on chip components (Corresponding part only)</p> <p>Digital force gauge: ZTS-100N Motorized test stand: MX2-500N-L-V90 Optional attachment: SJ-TIP-02 Optional attachment: SJS-100N-L Optional attachment: XST-500N Optional cable: CB-528</p>	 SJ-TIP-02 Example 1 Image
Examples of Product Configuration SJ-TIP-03	
<p>Example 1 Code: 1S2010A IEC 62137-1-2:2007 Surface mounting technology - Environmental and endurance test methods for surface mount solder joint - Part 1-2: Shear strength test (Corresponding part only) (Japanese Standards: JIS C 62137-1-2: 2010) (Corresponding part only) (For small sample and tip diameter is 2mm or less)</p> <p>Digital force gauge: ZTS-100N Motorized test stand: EMX-500N Optional attachment: SJ-TIP-03 Optional attachment: SJS-100N-S Optional cable: CB-528 Optional software: Force Recorder Standard</p>	 SJ-TIP-03 Example 1 Image

* Refer to the specification of each product for the detail.



* Depending on the sample characteristics, product configuration, and measurement requirements vary, contact our authorized distributor or us for more information

* The maximum load value of the force gauge varies depending on the measuring sample requirements.

Related Products		
Alignment stage for solder joints strength test SJS-100N-L/S	X-Axis slide table XST-500N	Chip peel Fixture GT-10/20
Designed for fixing a PCB to test pull and shear strength of solder joints, adjusting PCB's position in the XY-axis direction finely. Able to change the angle to 45 degrees or 90 degrees.	Designed to move and adjust the stage in the X-axis direction easily	Ideal for shear test of electric components (Capacity: 500N)
Small Grip SC-3/8	Pantograph Grip PGC-0505	Peeling Tester IPTS-5N
Ideal for measurement of thin samples and narrow space such as electronic component	Ideal for measurement in narrow spaces due to the thin chuck part	Specialized for easy and precise peel test of embossed carrier tape

Accessories
Interchangeable Blade Model: QFP45-SB-1
Interchangeable blade for SJ-QFP-01

For enlarging the detailed work	
Magnifying glass enlarges the magnification to 2x or 4x and the neck angle can be adjusted freely, which improves the work efficiency.	
	<p>2x 4x Rotate 360 degree Adjust the arm direction Pull in the direction of the arrow to remove</p> <p>Goose Neck Magnifier Magnet type 1720PM</p>
Image	

Related Standards of Electronic Component	
Peel test of embossed carrier tape, which complies with corresponding part of IEC 60286-3 (2013) and JIS C0806-3 (2014)	Breaking strength test of cover tape, which is a requirement of JIS C 0806-3 (2014)
	
Example Specialized tester: IPTS-5N	Example (*) Code: 1G2005A Digital force gauge: ZTS-200N Motorized test stand: MX2-500N-L Optional attachment: GC-60x2 Optional cable: CB-528

[Dimensions]

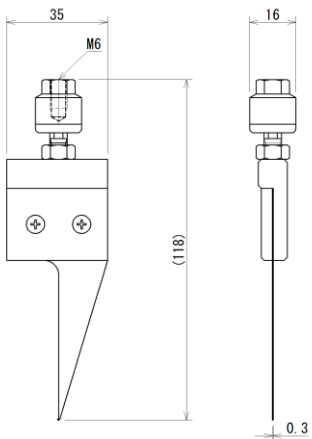
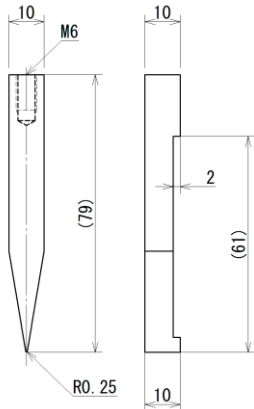
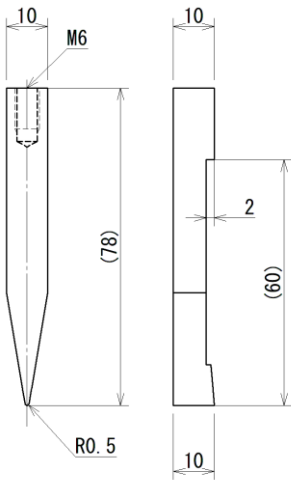
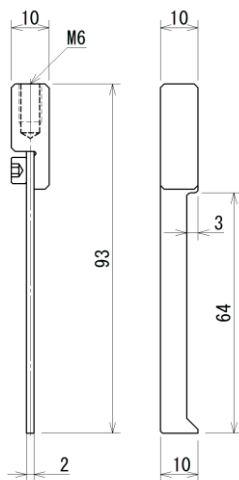
<p>SJ-QFP-01</p> 	<p>SJ-TIP-01</p> 
<p>SJ-TIP-02</p> 	<p>SJ-TIP-03</p> 
<p>SJ-TIP-04</p>	Unit : mm

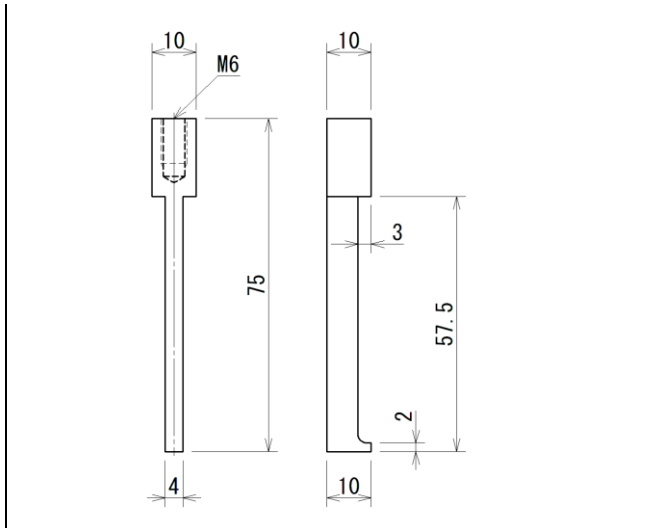

[Cautions]

- The contents may be changed without prior notice.
- A force gauge (sold separately) is required to use this product.
- This product is designed for force testing only. Do not use it for any other purposes.
- Some samples may not be suitable to measure.
- Do not copy and use this content without authority.

SHRADDHA IMPEX
Authorized Distributor

Email: shraddhaimpex@gmail.com / sales@shraddhaimpex.net

Web: www.shraddhaimpex.net

Contact: +91 9819530352 / +91 8591279918

