

Attachments for MTS series

Attachments for test torque stand MTS series
 Various attachments are available to suit your samples

Various attachments are available to suit different size, shape and material of samples.



Standard Chuck





Small Table



Pin Chuck



M10 Adapter

Testing image		
Opening torque test of glass bottle	Opening torque test of PET bottle	Durability test of PCB
		

Standard chuck

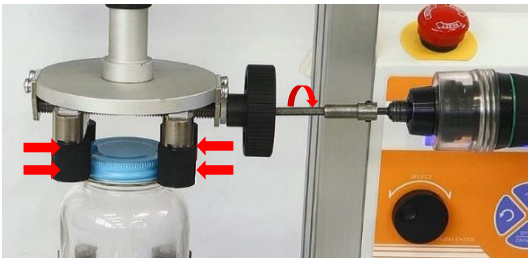
		Feature
	<p>Clamping force of the sample can be adjusted by tightening the center screw.</p> <p>Model: MT-TB Capacity: 10N-m Allowable sample diameter: $\phi 20 \sim 90\text{mm}$</p> <p>*Please feel free to contact us when you need to purchase only the pins.</p>	<div style="text-align: center;">  </div> <p>Enables high repeatability torque measurement by constantly fastening with torque measuring instrument.</p>

[Dimensions]

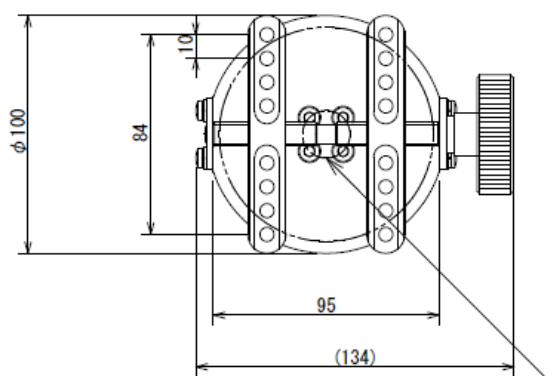



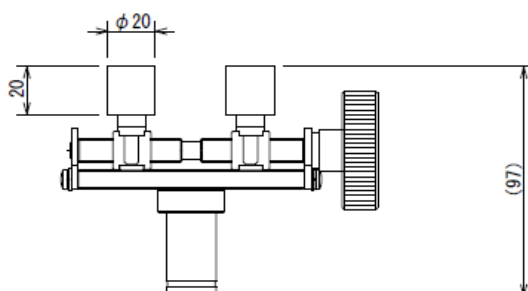
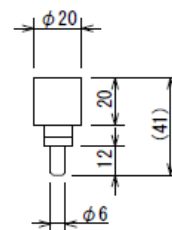
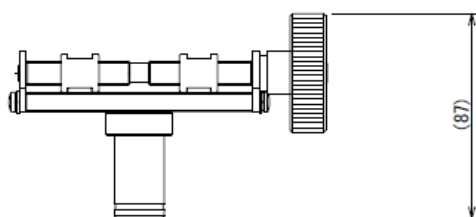
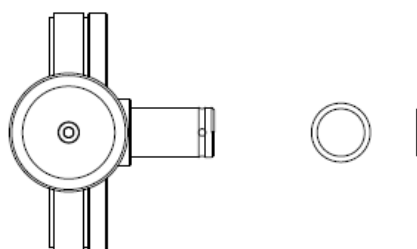

Allowable sample diameter $\phi 20 \sim \phi 90$



The dimension at mounting the pins

Unit: mm

Small Table (For 2/5N-m range)

Table	Pin	Feature
 <p>Small Table</p> <p>Capacity: 5N-m Allowable Sample Diameter: $\phi 7 \sim 50$mm Weight: Approx.270g Material: Steel and Aluminum</p>	 <p>Standard Pin</p>	<p>Suitable for measuring small samples such as eye drop lids.</p> <p>Pin weight: Approx.3g/pcs Pin material: Aluminum and Urethan</p>
	 <p>Notch Pin</p>	<p>Ideal for firmly fixing samples such as connectors made of resin.</p> <p>Pin weight: Approx.10g/pcs Pin material: Stainless-steel</p>
	 <p>Long Clamp Pin</p>	<p>Ideal for fixing slim samples such as cosmetic containers.</p> <p>Pin weight: Approx.8g/pcs Pin material: Aluminum and Urethan</p>

* Small table and pins cannot be used for 0.5N-m range.

[Product Models]

Set	Pin	Model
Small Table + Pins	Standard Pin	MT-ST
	Notch Pin	MT-ST-01
	Long Clamp Pin	MT-ST-02
Pins	Standard Pin	ST-P
	Notch Pin	ST-01P
	Long Clamp Pin	ST-02P

* 4 pins as a set is sold.

[Dimensions]

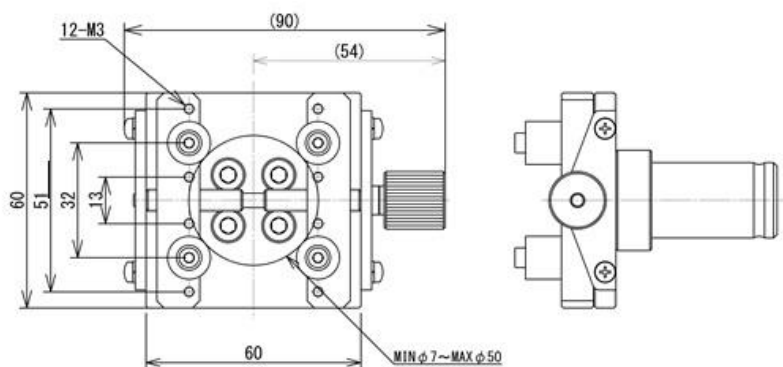

Pins

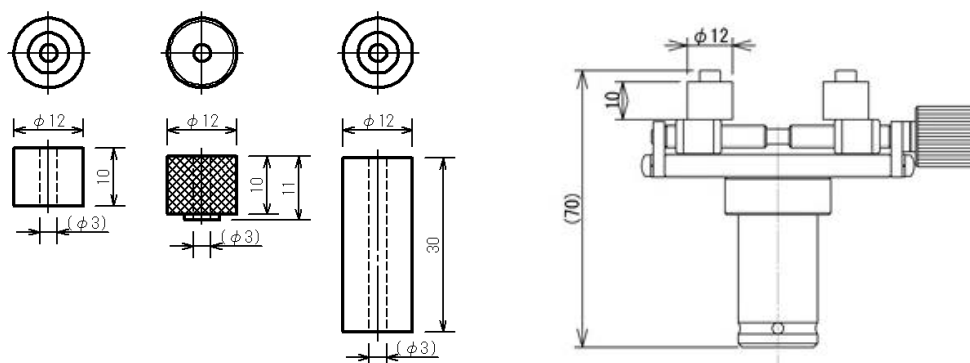

Unit: mm

Pin Chuck

	Feature
	The three claws clamp samples such as wire and round-bar samples.

[Specifications]

Model	MT-DC-4	MT-DC-6.5	MT-DC-6.5SUS	MT-DC-13
Maximum torque	5N-m	10N-m	10N-m	10N-m
Opening width	φ0.5~4mm	φ0.5~6.5mm	φ0.5~6.5mm	φ1.2~13mm
Weight	Approx.170g	Approx.270g	Approx.270g	Approx.650g
Material	Steel	Steel	Stainless-steel (*)	Steel

* We recommend using the stainless-steel chuck under the circumstance making metal rust.

[Dimensions]

MT-DC-4

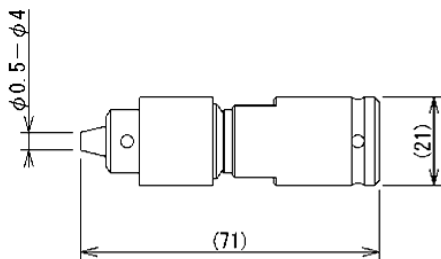

MT-DC-6.5/ MT-DC-6.5SUS

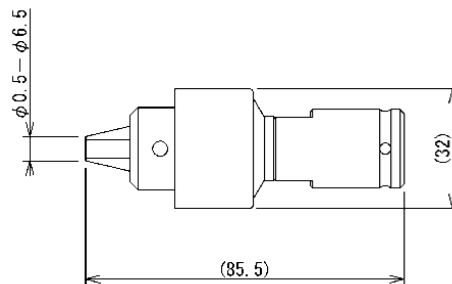

MT-DC-13

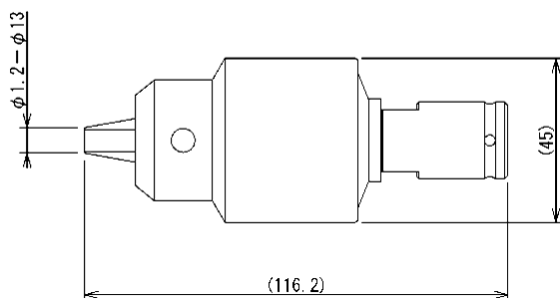

Unit: mm

M10 adapter

	Feature
	<p>The adapter for mounting an original jig by the customers. The customers can use their own jig to measure torque.</p>

[Specifications]

Model	MT-AD-M10
Screw	M10×L20
Weight	Approx.50g

[Dimensions]

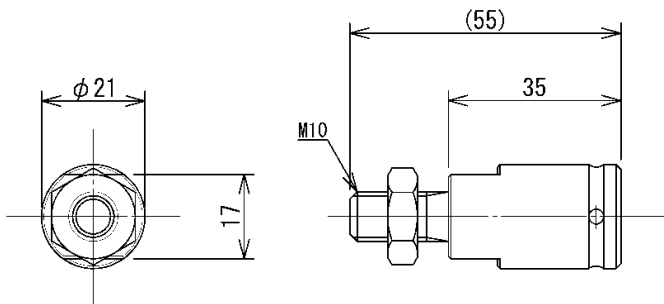

Unit: mm

[Cautions]

- Information in this document is subject to change without prior notice.
- This document is product descriptions and handling precautions, and do not guarantee various characteristics or safety.
- This product is designed for force measurement purpose only.
- Do not copy and use this content without authorization.
- Some samples may not be suitable to measure with this product.

SHRADDHA IMPEX
 Authorized Distributor

Email: shraddhaimpex@gmail.com / sales@shraddhaimpex.net

Web: www.shraddhaimpex.net

Contact: +91 9819530352 / +91 8591279918