

# Coefficients of Friction Fixture COF Series

Designed for coefficients of friction (COF) test of film and paper  
Automatically calculates Static and Ave. Kinetic COF by the supplied software  
Complies with a part of ISO and JIS standard



Horizontal Type: COF2-2N



Coefficients of Friction  
Test Image  
(Film)

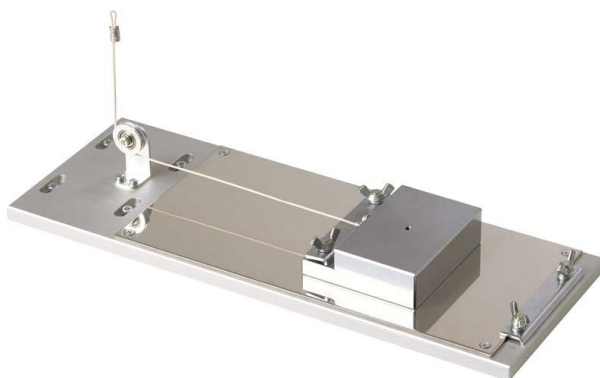

Vertical Type: COF-10N-V

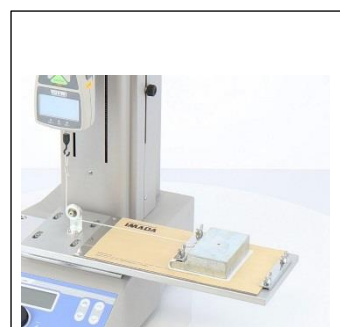

Coefficients of Friction  
Test Image  
(Paper)

**Related  
Standard**

-**ISO 8295:1995** Plastics -Film and sheeting-Determination of the coefficients of friction (Partly) (When COF2-2N or COF-2N-V is used)  
(Corresponding Japanese standard: **JIS K7125:1999**)  
-**JIS P8147:2010** Paper and board-Determination of the static and kinetic coefficients of friction (Partly) (When COF2-10N orbCOF-10N-V is used)

How to install test sample (COF2-2N)		
Fix the sample to the table.	Adhere the sample to the weight.	Hook the cord of weight to the attachment of force gauge. (*1)

\*1 The supplied standard attachment A-1 of force gauge is used.

Main Function of the Supplied Software		
Basic operation	<p><b>-Save graphs automatically</b> It enables automatic graphing and data saving by using trigger function.</p> <p><b>-Switch graphs with plural tabs</b> The recorded graphs can be displayed in plural tabs.</p> <p><b>-Add notes</b> Notes can be inserted at desired points on the graph.</p>	
Advance operation	<p><b>-Overlay graphs</b> Max. 5 graphs can be overlaid. It can be printed and output in desired format.</p> <p>It allows you to print or output overlaid data in desired format.</p> <p><b>-Zoom graph</b> Simply click and drag to specify an area to zoom-in. The Max, Min, and Ave. values of the selected area are displayed. It allows you to print or output in desired format.</p>	
Display	<p><b>-Automatically calculate the COF</b> The Static and Ave. Kinetic COF can be automatically calculated by input the weight of weight.</p> <p><b>-Display statistics</b> The Max, Min, and Ave. values can be displayed.</p> <p><b>-Input comments</b> Notes such as testing conditions up to 198 characters can be input.</p>	
Output	<p><b>-Print test results</b> Prints out in A4 or letter size.</p> <p><b>-Output data</b> The data can be output in Word, Excel, and PDF format. Graph is attached as an image file.</p>	

Specifications				
Type	For film		For paper	
	Horizontal type	Vertical type	Horizontal type	Vertical type
Model	<b>COF2-2N</b>	<b>COF-2N-V</b>	<b>COF2-10N</b>	<b>COF-10N-V</b>
Weight of weight	200g (Approx. 2N)		1000g (Approx. 10N)	
Sample thickness	Max. 1.5mm			
Stroke	Max. 150mm			
Dimensions	See [Dimensions]			
Table weight	Approx. 2.0kg	Approx. 1.9kg	Approx. 2.0kg	Approx. 1.9kg
Compatible test stands *1	MH2-500N	EMX series MX2 series MX series	MH2-500N	EMX series MX2 series MX series
Compatible force gauge *1	Digital force gauge ZTS/ZTA series			
Accessory	Graphing software Force Recorder Standard COF ver.			

\* Weight of the attachment is also applied as a load on the force gauge. Consider it when selecting the capacity of a force gauge.



\* The supplied standard attachments A-1, S-1, or SR-1 is recommended for COF test.

\* The testing results by horizontal type and vertical type may be different. Please compare the results by using the same type product.

\*1 Contact us for compatibility of other models of test stands and force gauges.

Specifications of the supplied software	
Data transferring speed	Max. 2000 data / sec (2000Hz)
Recording data point	Max. 7.2 million
Functions	Graph overlaying function, Capture function, Graph scaling, Automatic calculation of COF, Statistics output, Point marking
Graph recording	Trigger function
Edit	Comment, Add notes, Borderline function
Output	Printing (A4, letter size), CSV, Word, Excel, PDF
OS	Windows 7/8/8.1/10
Hardware	CPU: Pentium4(1GHz or more) or more is recommended. Memory: 2GB or more is recommended. Hard disk (data storage area): 10GB or more is recommended.
Plat form	.NET Framework4.6 or later
Execute environment	Microsoft Internet Explorer 6 or later Windows installer 3.1 or later
Image size	Resolution 1024x768 pixel or more
Connection port	USB1.1, USB2.0 connecor * Operation in USB 3.0 has not been varified.

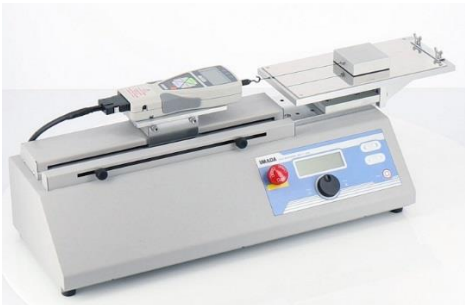
\* Some old versions of Excel show data up to 65,531 only.

Examples of Product Configuration COF2-2N	
<p><b>Example 1      Code: 1C2003A</b> Coefficients of friction test according to a part of <b>JIS K 7125:1999</b> and <b>ISO 8295:1995</b> by using horizontal type test stand and optional attachment.</p> <p>Digital Force Gauge: ZTS-5N Motorized Test Stand: MH2-500N Optional Attachment: COF2-2N Optional Cable: CB-528</p>	 <p>COF2-2N Example 1 Image</p>
Examples of Product Configuration COF-2N-V	
<p><b>Example 1      Code: 1C2004A</b> Coefficients of friction test according to a part of <b>JIS K 7125:1999</b> and <b>ISO 8295:1995</b> by using vertical type test stand and optional attachment.</p> <p>Digital Force Gauge: ZTS-5N Motorized Test Stand: MX2-500N Optional Attachment: COF-2N-V Optional Cable: CB-528</p>	 <p>COF2-2N-V Example 1 Image</p>
Examples of Product Configuration COF2-10N	
<p><b>Example 1      Code: 1C2005A</b> Coefficients of friction test according to a part of <b>JIS P 8147:2010</b> by using horizontal type test stand and optional attachment.</p> <p>Digital Force Gauge: ZTS-50N Motorized Test Stand: MH2-500N Optional Attachment: COF2-10N Optional Cable: CB-528</p>	
Examples of Product Configuration COF-10N-V	
<p><b>Example 1      Code: 1C2006A</b> Coefficients of friction test according to a part of <b>JIS P 8147:2010</b> by using vertical type test stand and optional attachment.</p> <p>Digital Force Gauge: ZTS-50N Motorized Test Stand: MX2-500N Optional Attachment: COF-10N-V Optional Cable: CB-528</p>	

\* Refer to the specification of each product for details.

\* Product configuration varies depending on the shape and characteristic of the sample, and measurement conditions.

\* The recommended capacity of force gauge varies depending on the expected force to be loaded.

Related Products		
<b>Film Grip</b> <b>FC-21/20/40/21U/41U/21UQ</b>	<b>Cam Grip</b> <b>GR-30/2000</b>	<b>Fixture for Film Sticking Test</b> <b>TKS-20N/250N</b>
Ideal for gripping thin samples such as film. A wide range of product models are available to fit your needs.	Ideal for gripping thin and rectangle shaped samples such as paper and sheet.	Designed for sticking test of thin samples such as film.
		

(Separate model without software, and weight only are available to meet your needs.)

Table + Weight Model				
Type	For film		For paper	
	Horizontal type	Vertical type	Horizontal type	Vertical type
Model	<b>COF2-2N-J</b>	<b>COF-2N-V-J</b>	<b>COF2-10N-J</b>	<b>COF-10N-V-J</b>
Weight of weight	200g (Approx. 2N)		1000g (Approx. 10N)	
Weight Model				
Type	For film		For paper	
	Horizontal type	Vertical type	Horizontal type	Vertical type
Model	<b>COF2W-2</b>	<b>COFW-2-V</b>	<b>COF2W-10</b>	<b>COFW-10-V</b>
Weight of weight	200g (Approx. 2N)		1000g (Approx. 10N)	

Customized Applications
<b>-ASTM D1894-14</b> Standard Test Method for Static and Kinetic Coefficients of Friction of Plastic Film and Sheeting (Partly)

\* The customized model enables you to carry out COF test according to a part of ASTM standard. Contact us for details.

**[Dimensions]**

**Horizontal type**

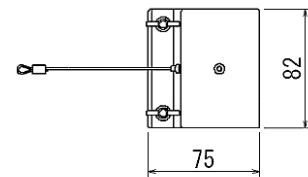
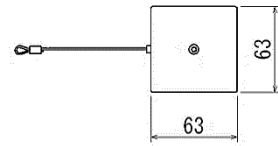
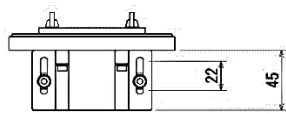
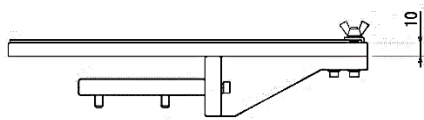
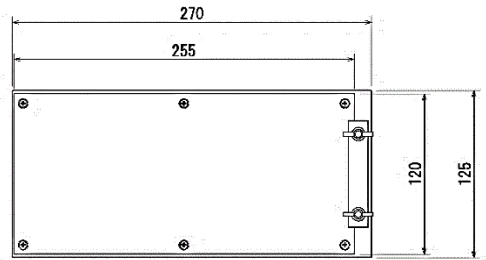

**Vertical type**

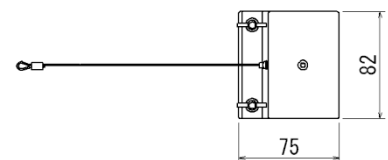
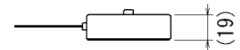
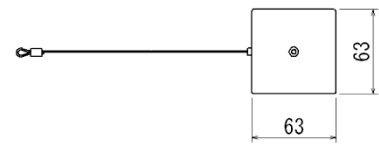
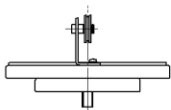
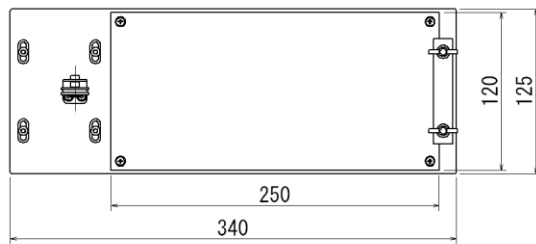

Unit: mm

**[Cautions]**

- Information in this document is subject to change without prior notice.
- This document is product descriptions and handling precautions, and do not guarantee various characteristics or safety.
- This product is designed for force measurement purpose only.
- Do not copy and use this content without authorization.
- A force gauge (sold separately) is required to use this product.
- Some samples may not be suitable to measure with this product.

SHRADDHA IMPEX  
Authorized Distributor

Email: [shraddhaimpex@gmail.com](mailto:shraddhaimpex@gmail.com) / [sales@shraddhaimpex.net](mailto:sales@shraddhaimpex.net)

Web: [www.shraddhaimpex.net](http://www.shraddhaimpex.net)

Contact: +91 9819530352 / +91 8591279918