

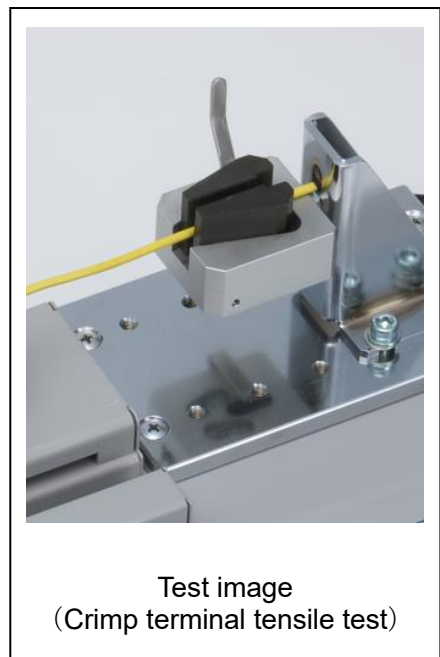

Wire Clamp Grip CW-500N

- The wedge type grip for wire/cable
- Designed to secure a sample very easily
- Self-tightening



How to install test sample	
Pull up the lever to open its jaws.	Put a cable between the jaws.
	

Specifications	
Model	CW-500N
Capacity	500N
Clamp method	Wedge clamp *
Opening width	5mm
Size	See the Dimensions
Weight *1	Approx. 220g
Mounting screws	M6

* It is NOT suitable for hard sample as quenched or slippery samples.

* Soft or thin-covering cable could be broken.

* CW-500N is attachable for our horizontal stands. For our vertical stands, please use GP-30.

*1 Weight of the attachment is also applied as a load on the force gauge. Consider it when selecting the capacity of a force gauge.

Examples of Product Configuration

<p>Example 1 (*1) Code: 1C2001A</p> <ul style="list-style-type: none"> - Crimp pull test up to 500N - Automatically pulls a crimp terminal until it breaks and measure the strength - Versatile to fit a wide range of samples - Easy sample setting due to horizontal design <p>Digital force gauge: ZTS-500N Motorized test stand: MH2-500N Optional attachment: CH-500N Optional attachment: CW-500N Optional cable: CB-528</p>	
---	--

*Refer to the specification of each product for details.





*Product configuration varies depending on the shape and characteristic of the sample, and measurement conditions.

*The recommended capacity of force gauge varies depending on the expected force to be loaded.

Mountable Force Gauges

Digital force gauge DST/DSV series	Digital force gauge ZTS/ZTA series	Mechanical force gauge FB/PS/PSM series
<ul style="list-style-type: none"> - Affordable model - Easy data management on PC 	<ul style="list-style-type: none"> - High sampling speed - High functionality - High precision 	<ul style="list-style-type: none"> - Easy Handling

*Select suitable force gauge to correspond with the mounting screws of attachment.

Related Products		
<p>Terminal clamp jig CH-500N</p> <p>It secures a crimp terminal.</p> 	<p>High capacity wire clamp jig CW-5000N</p> <p>It secures a wire in capacity up to 5000N.</p> 	<p>Loop Tensile test fixture LOP-1000N</p> <p>It is designed for tensile test of PP band in capacity up to 1000N.</p> 
<p>Automatic crimp tester ACT-1000N</p> <p>It tests tensile strength of a wire crimp terminal automatically. A supplied software enables data management and test condition setting very easily.</p> 	<p>Test stand for crimp pull test LH-500N</p> <p>You can easily handle it due to simple lever operation. It comes with optional attachments.</p> 	

[Dimensions]

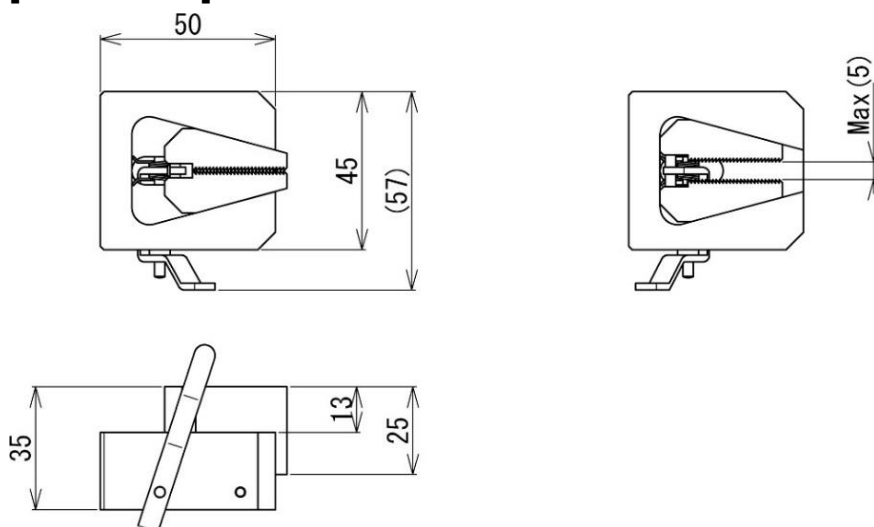

Unit: mm

[Cautions]

- Specifications are subject to change without prior notice.
- A force gauge (sold separately) is required to use this product.
- This product is designed for force testing only. Do not use it for any other purposes.
- Some samples may not be suitable to grip with this product.
- Do not copy and use this content without authorization.

SHRADDHA IMPEX
Authorized Distributor

Email: shraddhaimpex@gmail.com / sales@shraddhaimpex.net

Web: www.shraddhaimpex.net

Contact: +91 9819530352 / +91 8591279918