

Vise Grips

Vise grips to fix samples to a test stand.

Vise grips for multi purposes.

Variety of vise is available depending on sample materials and measurement





<p>Standard Type (Lever) Vise grip with one side open.</p>	<p>Model: GT-30 Capacity: 1000N Grip Width: 38mm Opening Width: 38mm Weight: Approx. 1100g</p>	
<p>Hard Grip Type (Lever) Vise grip with one side open and both jaws have nicks. Suitable for slippery samples.</p>	<p>Model: GT-30-E Capacity: 1000N Grip Width: 38mm Opening Width: 35mm Weight: Approx. 1100g</p>	
<p>Polyurethane Grip Type (Lever) Vise grip with one side open and a jaw has polyurethane. Suitable for delicate films as urethane avoids breaking films.</p>	<p>Model: GT-30-U Capacity: 250N Grip Width: 38mm Opening Width: 35mm Weight: Approx. 1100g</p>	
<p>High capacity Type (Lever) Vise grip up to 2000N with one side open for bigger samples. Fixable by front or side lever direction on a test stand.</p>	<p>Model: GT-2000N Capacity: 2000N Grip Width: 62mm Opening Width: 64mm Weight: Approx. 4400g</p>	
<p>Double Opening Type (Lever) Easy positioning with both sides simultaneously open. Lever makes possible to fix firmly. * Not suitable for short and small samples</p>	<p>Model: GTW-50L Capacity: 1000N Grip Width: 50mm Opening Width: 68mm Weight: Approx. 3kg</p>	
<p>Double Opening Type (Knob) Easy positioning with both sides simultaneously open. Knob makes easy operation. * Not suitable for short and small samples</p>	<p>Model: GTW-50R Capacity: 500N Grip Width: 50mm Opening Width: 68mm Weight: Approx. 3kg</p>	

* It is not suitable for soft samples.

Options	
Vise Jaws for GT-30-E Model: GT30-S10	Vise Jaws for GT-30-U Model: GT30-S30 (nick side) Model: GT30-S40 (polyurethane side)
*Attachable to GT-30 (standard type) *This model is sold in 1 piece. Please order 2 pieces when used for both sides.	*Attachable to GT-30 (standard type) *This model is sold in 1 piece.

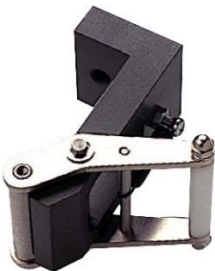
Measurement Example	
Stuffing and pulling out test of plastic materials	180 degrees peeling test of film

Attachable Test Stands			
Motorized Test Stand		Manual Test Stand	
MX-500N	MX2-500N	SVL-1000N	HV-500N2
MX-1000N	MX2-1000N	SVH-1000N	HV-1000N
MX-5000N	MX2-2500N		HV-3000N
	EMX-1000N		

Related Products		
<p>T-Slot Table TS-5000N</p>	<p>Roller Grip GC-60/GC-100</p>	<p>Flat Chuck GC-1100/GC-1200/GC-5000</p>
<p>With this fixture, it is easier to exchange grips or position center them by sliding nut. Available in capacity up to 5000N (500kgf).</p>	<p>They hold a sample by the winding mechanism. It is ideal for measurement of flexible sample such as rubber, film, tape, etc.</p>	<p>They have a wide opening width, securing a wide range of samples from thin to thick.</p>
		
<p>Film Grip FC-21/20/40/21U/41U/21UQ</p>	<p>Wedge Grip KC-100/1001/5000</p>	
<p>The grips hold a thin sample such as film. Some of models have urethan on the one side of the jaw to prevent the sample from breaking.</p>	<p>The wedge grips are ideal for holding wire or cable. The easy clamping mechanism offer you high efficient measurement.</p>	
		

[Dimensions]

GT-30

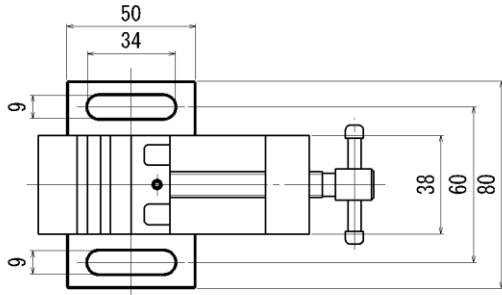

	Opening width
GT-30	Max. 38mm
GT-30-E	Max. 35mm
GT-30-U	Max. 35mm

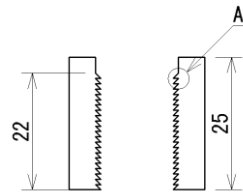

Vise Jaws for GT-30-E

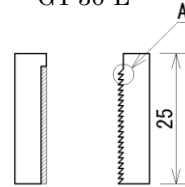

Vise jaws for GT-30-U

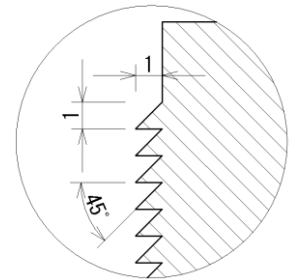
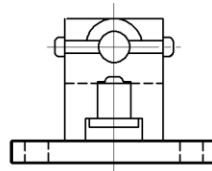
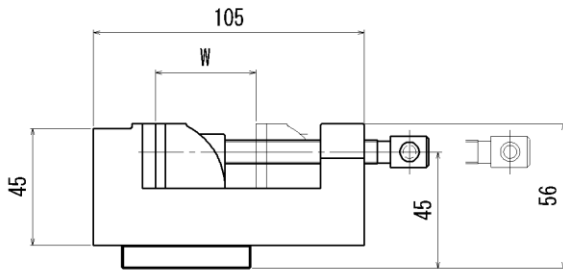

Enlarged A

Unit: mm

GTW-50R / GTW-50L

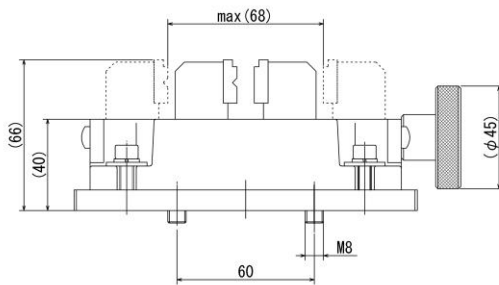
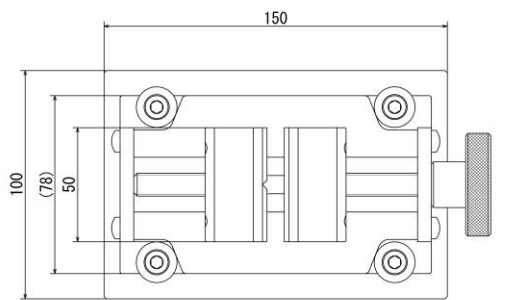

GTW-50L (Knob)

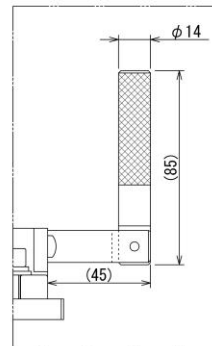

GTW-50L (Lever)

Unit: mm

Feb 20, 2018

GT-2000N

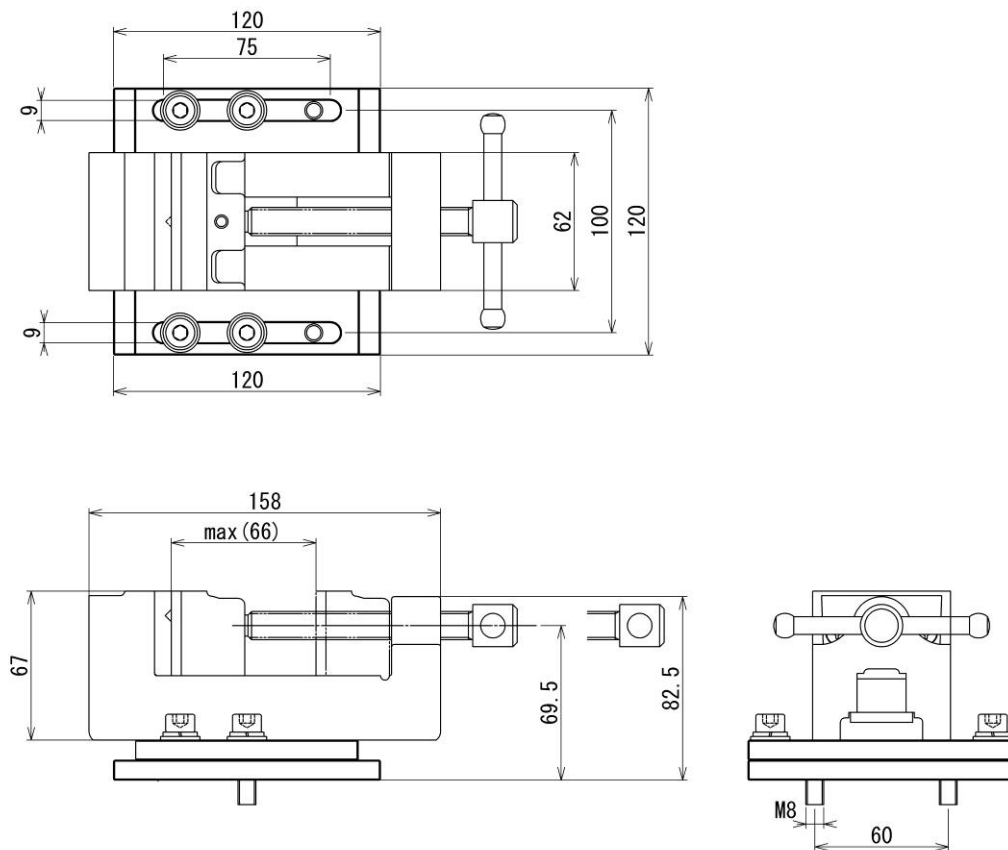

Unit: mm

[Cautions]

- Specifications are subject to change without prior notice.
- A force gauge (sold separately) is required to use this product.
- This product is designed for force testing only. Do not use it for any other purposes.
- Some samples may not be suitable to grip with this product.
- Do not copy and use this content without authorization.

SHRADDHA IMPEX
Authorized Distributor

Email: shraddhaimpex@gmail.com / sales@shraddhaimpex.net

Web: www.shraddhaimpex.net

Contact: +91 9819530352 / +91 8591279918