







# Muscle Force Measurement Device

- Designed for muscle strength test and job task analysis (workload test)
- Includes various attachments and pads to perform different testing applications
- 3 models of kits available to meet your testing needs

## RZTA-1000N









### Supplied attachments and pads

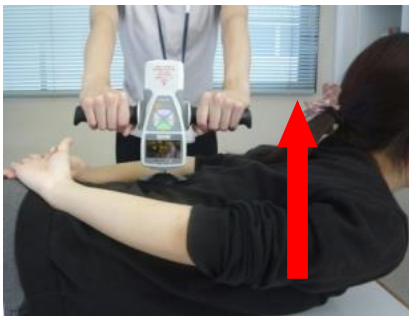

Test type	Compression	Compression	Compression	Compression	Tension	Tension
Name	Rectangular pad	Curved pad	Square pad	Round pad	Large hook	Y hook
Image						

### Features

Various attachments and pads	Carrying case	Easy data management
6 types of attachments and pads enable different testing.	Force gauge mounted handle can put attached carrying case.	A peak value and date/time can be saved in force gauges or USB. (RDSV/RZTA only)

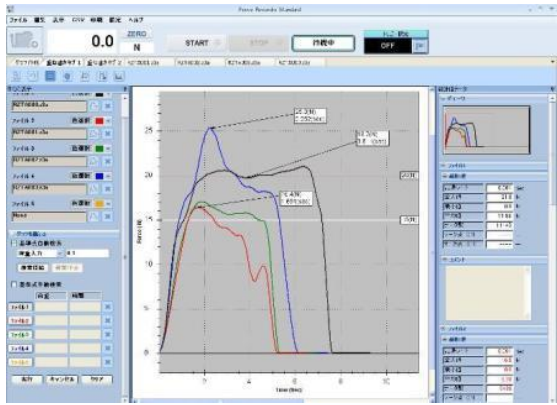
Testing image	
Arm muscle strength test (with a curved pad)	Leg muscle strength test (with a curved pad)
	
Back strength test (with a round pad)	Tongue strength test (with a square pad)
	
Force test to open a door (with a Y hook)	Force test to push a cart (with a round pad)
	

Force graphing for visual analysis	
<p>With a graphing software included in RZTA-1000N, force transition is visualized with graphs and you can...</p> <ul style="list-style-type: none"> <li>- See force durability</li> <li>- Overlay and compare graphs</li> <li>- Add comments</li> <li>- Save data in Word/Excel/PDF etc.</li> </ul> <p>The graphing software makes it possible to analyze and manage data very easily.</p>	

Specifications				
Model	RZTA-1000N	RDSV-1000N	RFB-750N	
Image				
Features	Main Feature	Functional model for various purpose including data analysis with graphing and direct data saving to USB drive.	Standard model with useful function. Tilt-sensing alarm enables stable testing.	Mechanical model for easy visual reading of force transition.
	Peak	✓+	✓+	✓+
	Visible Force Transition	✓++	✓	✓+
	Data Management on PC	✓++	✓+	-
	Graphing	✓+	-	-
Specifications	Capacity	1000N	1000N	750N
	Unit	N (kN), kgf, *1	N (kN), kgf *1	N *1
	Accuracy	+/- 0.2% F.S. +/- 1 digit	+/- 0.2% F.S. +/- 1 digit	+/- 0.3% F.S.
	Sampling Rate	Max. 2000 times/sec	Max. 1000 times/sec	-
	Sensitivity	4 steps	3 steps	-
	Display	4-digit graphic organic EL	4-digit graphic LCD	Dial indicator
	Power	Internal battery, AC adapter	Internal battery, USB charge (AC adapter)	-
	Battery	Approx. 6.5 continuous hours of use by 2-hour charge	Approx. 30 continuous hours of use (with backlight off) by 4.5-hour charge	-
	Weight	Approx. 1kg	Approx. 1kg	Approx. 1.1kg
Functions	Peak Hold	✓+	✓+	✓+
	Judgement	✓++ (OK,NG)	✓+ (OK only)	-
	Calendar	✓+	✓+	-
	Bar Graph	✓+	-	-
	Overload Warning	✓+	✓++ (w/ Precaution Alarm)	-
	Tilt-sensing Alarm	-	✓+	-
	Language	JP, EN, CN, ES, DE, FR, IT, KO	JP, EN	-
	Internal Memory	✓+ (1000 data)	✓+ (1000 data)	-
	USB Drive *2	✓+	-	-
	Graphing	✓+	-	-
Accessory	Handle, attachment pads (6 types), carrying case, inspection certificate			
	USB cable, software for data management, graphing software, AC adapter, USB drive	USB cable, software for data management, AC adapter	Protection cap	

\*1 It is for international models. Available units for Japanese domestic models are different.

\*2 Continuous data for graphing can be saved at 100 data/ sec.

**[Dimensions]**

**RZTA-1000N**

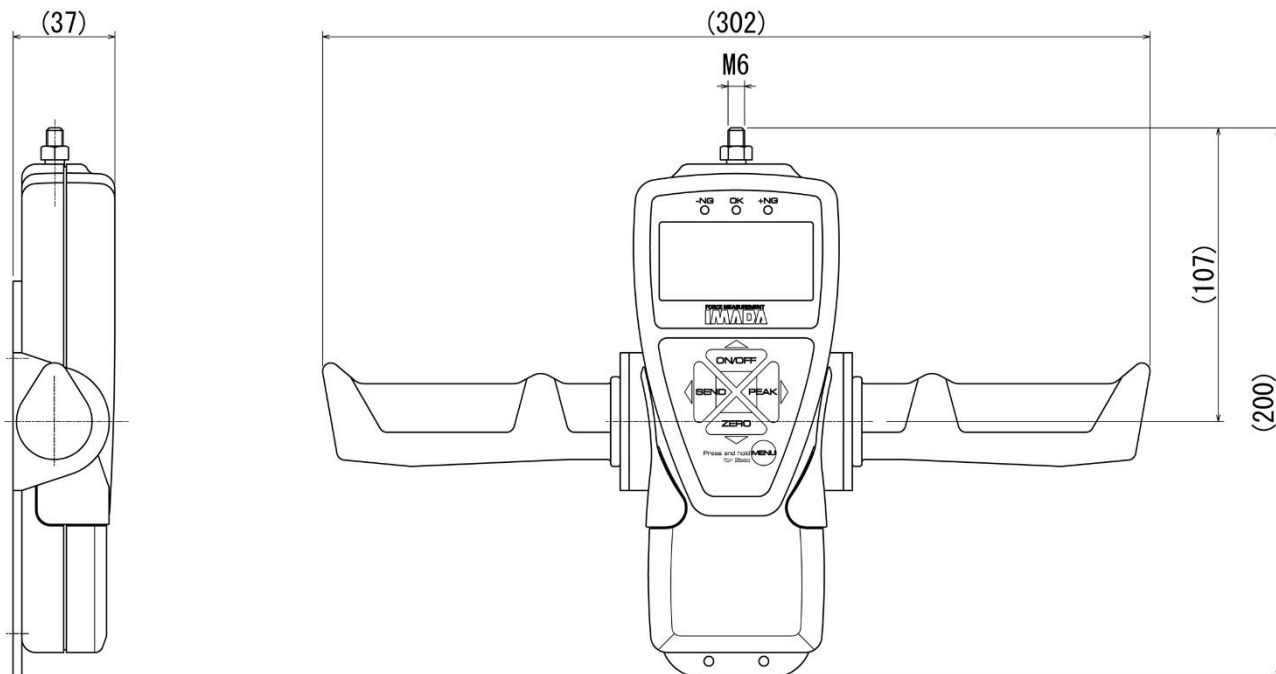

**RDSV-1000N**

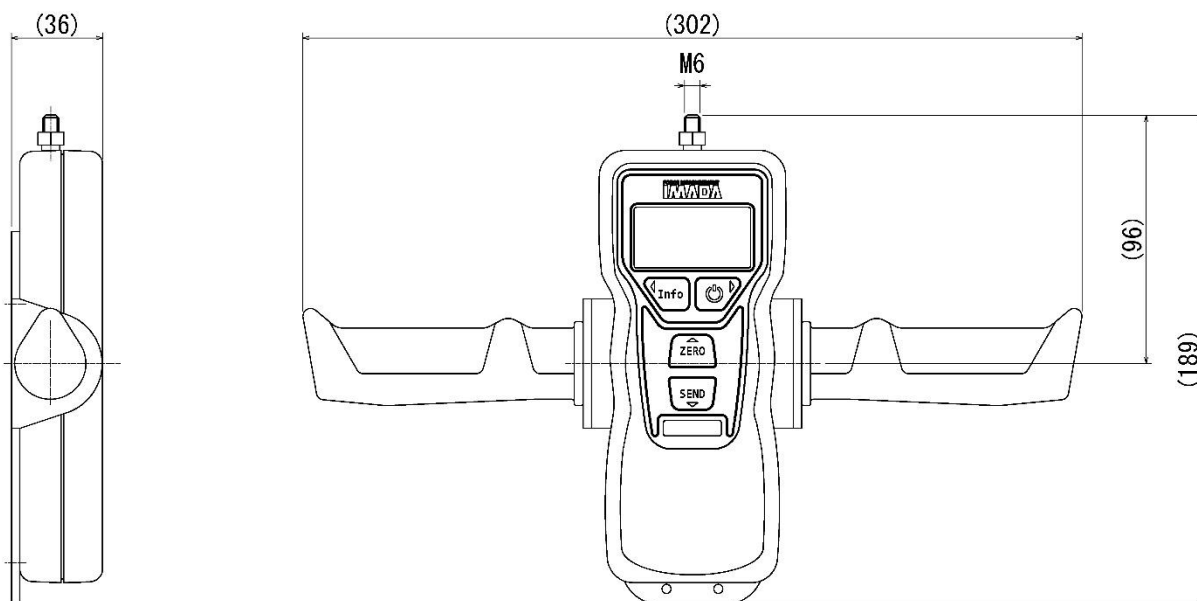

**RFB-750N**

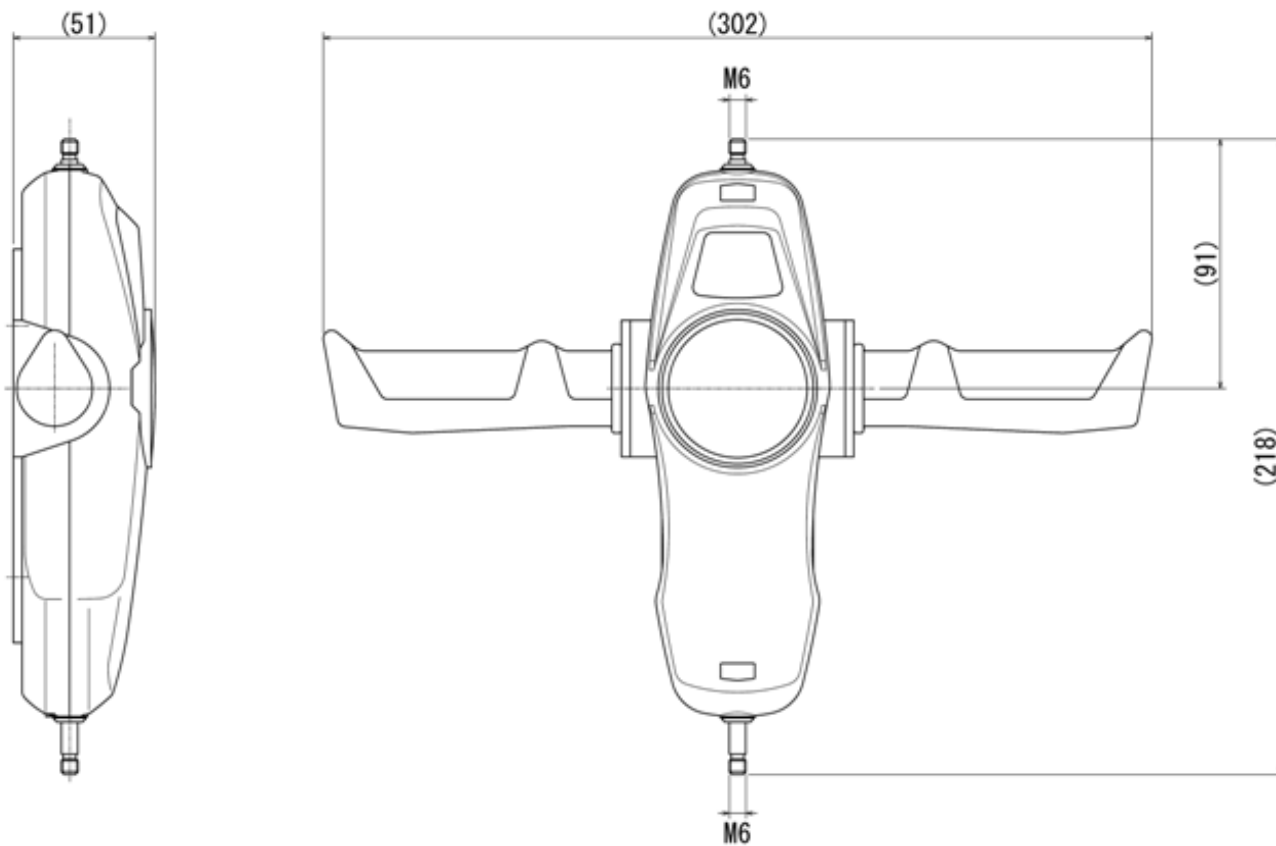

Unit: mm

**[Cautions]**

- Information in this document is subject to change without prior notice.
- This document is product descriptions and handling precautions, and do not guarantee various characteristics or safety.
- This product is designed for force measurement purpose only.
- Do not copy and use this content without authorization.
- Do not apply force more than its capacity or from incorrect direction to the measuring shaft.
- Do not use this product in the environments including fierce temperature changes, high temperature, high humidity, near water, dusty place.

SHRADDHA IMPEX  
Authorized Distributor

Email: [shraddhaimpex@gmail.com](mailto:shraddhaimpex@gmail.com) / [sales@shraddhaimpex.net](mailto:sales@shraddhaimpex.net)  
Web: [www.shraddhaimpex.net](http://www.shraddhaimpex.net)  
Contact: +919819530352 / +918591279918