

Hand Sockets 3/8"

3400M • 3400A

6-point Sockets
Vasos Hexagonales

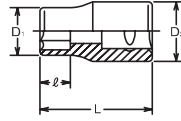

3405M • 3405A

12-point Sockets
Vasos Bihexagonales

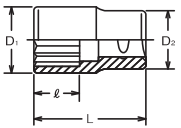

FLAT DRIVE®

Flat drive is designed to guarantee a flat surface contact between the socket and the bolt/nut. The Flat contact reduces wear and allows to transmit a higher torque value. The Flat Drive System is also used for the square drive end as well as the hexagonal or bi-hexagonal openings of the socket.

El diseño de contacto plano garantiza una superficie de contacto plana entre el vaso y el perno/tuerca. El contacto plano reduce el desgaste y permite transmitir más par. El Sistema de Contacto Plano se utiliza tanto para el extremo del cuadrado conductor como para la boca del vaso Hex o Bihex.

RS3400M/8

Socket Set on Rail
Juego de Vasos en Regleta

RS3405M/8



RS3400M/12

Socket Set on Rail
Juego de Vasos en Regleta

RS3405M/12



RS3400A/9

Socket Set on Rail
Juego de Vasos en Regleta

RS3405A/9



3400M 3405M (mm)	D ₁ (mm)	D ₂ (mm)	ℓ (mm)	L (mm)	⚖️ (g)	📦 (pcs.)
5	8,3	17,3	5	26	20	10
5,5	8,9	17,3	5,5	26	20	10
6	9,9	17,3	6	26	20	10
7	10,8	17,3	6,5	26	20	10
8	12	17,3	7	26	22	10
9	13,3	17,3	7,5	26	23	10
10	14,5	17,3	8	26	24	10
11	15,8	17,3	8,5	26	25	10
12	16,8	17,3	9	26	25	10
13	18	17	9,5	26	24	10
14	19,5	18,5	11	27	31	10
15	20,8	19,5	11,5	28	39	10
16	22	20	12	28	42	10
17	23,3	21,5	12,5	29	51	10
18	24,5	22,5	13	30	51	10
19	25,8	23,5	13,5	30	63	10
20	27	24,5	14	31	75	10
21	28	26	14,5	32	77	10
22	29,5	26,5	15	32	82	10
23	30,8	27,5	15,5	33	95	10
24	32	28,5	16	34	102	10

	3400A 3405A (inch)	D ₁ (mm)	D ₂ (mm)	ℓ (mm)	L (mm)	⚖️ (g)	📦 (pcs.)
New	3/16	8,3	17,3	5	26	20	10
	1/4	10,3	17,3	6	26	20	10
New	9/32	10,8	17,3	6,5	26	20	10
	5/16	12	17,3	7	26	22	10
	11/32	13,3	17,3	7,5	26	23	10
	3/8	13,9	17,3	8	26	23	10
New	13/32	13,3	17,3	7,5	26	23	10
	7/16	15,8	17,3	8,5	26	25	10
	1/2	18	17	9,5	26	24	10
	9/16	19,5	18,5	11	27	31	10
	19/32	20,8	19,5	11,5	28	39	10
	5/8	22	20	12	28	42	10
	11/16	24,5	22,5	13	30	51	10
	3/4	25,8	23,5	13,5	30	63	10
	25/32	27	24,5	14	31	75	10
	13/16	28	26	14,5	32	77	10
	7/8	29,5	26,5	15	32	82	10
	15/16	32	28,5	16	34	102	10

RS3400M/8	8 Pieces Set/Rail 200mm	⚖️ (g)
8, 10, 11, 12, 13, 14, 17, 19		300

RS3405M/8	8 Pieces Set/Rail 200mm	⚖️ (g)
8, 10, 11, 12, 13, 14, 17, 19		300

RS3400M/12	12 Pieces Set/Rail 300mm	⚖️ (g)
8, 9, 10, 11, 12, 13, 14, 15, 16, 17, 18, 19		465

RS3405M/12	12 Pieces Set/Rail 300mm	⚖️ (g)
8, 9, 10, 11, 12, 13, 14, 15, 16, 17, 18, 19		465

RS3400A/9	9 Pieces Set/Rail 200mm	⚖️ (g)
1/4, 5/16, 3/8, 7/16, 1/2, 9/16, 5/8, 11/16, 3/4		333

RS3405A/9	9 Pieces Set/Rail 200mm	⚖️ (g)
1/4, 5/16, 3/8, 7/16, 1/2, 9/16, 5/8, 11/16, 3/4		333

3410M (mm)	D ₁ (mm)	D ₂ (mm)	ℓ (mm)	L (mm)	(g)	(pcs.)
5.5	8.9	17.3	5.5	26	20	10
6	9.9	17.3	6	26	20	10
7	10.8	17.3	6.5	26	20	10
8	12	17.3	7	26	22	10
9	13.3	17.3	7.5	26	23	10
10	14.5	17.3	8	26	24	10
11	15.8	17.3	8.5	26	25	10
12	16.8	17.3	9	26	25	10
13	18	17	9.5	26	24	10
14	19.5	18.5	11	27	31	10
15	20.8	19.5	11.5	28	39	10
16	22	20	12	28	42	10
17	23.3	21.5	12.5	29	51	10
18	24.5	22.5	13	30	51	10
19	25.8	23.5	13.5	30	63	10
20	27	24.5	14	31	75	10
21	28	26	14.5	32	77	10
22	29.5	26.5	15	32	82	10
23	30.8	27.5	15.5	33	95	10
24	32	28.5	16	34	102	10

RS3410M/12	12 Pieces Set/Rail 300mm	(g)
8, 9, 10, 11, 12, 13, 14, 15, 16, 17, 18, 19		468

3400W 3405W (W)	D ₁ (mm)	D ₂ (mm)	ℓ (mm)	L (mm)	(g)	(pcs.)
1/8	13.3	17.3	7.5	26	22	10
3/16	15.8	17.3	8.5	26	25	10
1/4	18	17	9.5	26	24	10
5/16	20.8	19.5	11.5	28	39	10
3/8	24.5	22.5	13	30	51	10
7/16	28	26	14.5	32	81	10
1/2	30.8	27.5	15.5	33	103	10
9/16	34.5	30.5	17	35	128	10

BS W	BS - W	BS	3/16BS	1/4BS	5/16BS	3/8BS	7/16BS	1/2BS	9/16BS	5/8BS	11/16BS	3/4BS	7/8BS
		W	1/8W	3/16W	1/4W	5/16W	3/8W	7/16W	1/2W	9/16W	5/8W	11/16W	3/4W
		Across Flat	(ref. mm)	8.64	11.30	13.34	15.24	18.03	20.83	23.37	25.65	27.94	30.48

RS3400W/7	7 Pieces Set/Rail 200mm	(g)
1/8, 3/16, 1/4, 5/16, 3/8, 7/16, 1/2		389

RS3405W/7	7 Pieces Set/Rail 200mm	(g)
1/8, 3/16, 1/4, 5/16, 3/8, 7/16, 1/2		389

3415M (mm)	D ₁ (mm)	D ₂ (mm)	ℓ (mm)	L (mm)	(g)	(pcs.)
6	12	17.3	6	26	26	10
8	14.5	17.3	7	26	26	10
10	16.8	17.3	8	26	27	10
12	20.8	19.5	9	27	43	10

3415A (inch)	D ₁ (mm)	D ₂ (mm)	ℓ (mm)	L (mm)	(g)	(pcs.)
1/4	12	17.3	6	26	24	10
5/16	14.5	17.3	7	26	26	10
11/32	15.8	17.3	7.5	26	27	10
3/8	16.8	17.3	8	26	27	10
7/16	19.5	18.5	8.5	27	37	10
1/2	22	20	9.5	27	46	10

3410M Surface Drive Sockets Vasos Surface Drive (de Contacto Curvo)

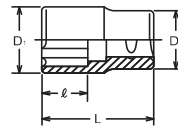

SURFACE DRIVE

Surface drive sockets are designed to retain contact with flat sides of nut to transmit high torque and reduce nut wear. These sockets are ideal for use on polished nuts, aluminum nuts and nuts with worn out points.

Los vasos de contacto curvo se diseñan para mantener el contacto con las caras planas de la tuerca y transmitir un alto par reduciendo el desgaste de la tuerca. Estos vasos son ideales para utilizarse en tuercas pulidas, tuercas de aluminio y tuercas con puntas gastadas

RS3410M/12 Socket Set on Rail Juego de Vasos en Regleta



3400W 6-point Whitworth Sockets Vasos Hexagonales Whitworth

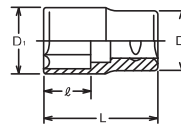

3405W 12-point Whitworth Sockets Vasos Bihexagonales Whitworth

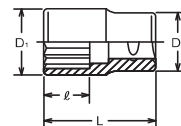

RS3400W/7 Socket Set on Rail Juego de Vasos en Regleta



3415M · 3415A Double Square Sockets Vasos Octagonales

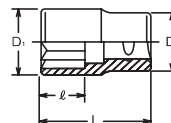

Hand Sockets **3/8"**

3425 TORX® Sockets Vasos TORX®

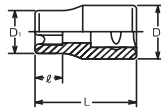

3425 (E)	D ₁ (mm)	D ₂ (mm)	ℓ (mm)	L (mm)	(g)	(pcs.)
E 4	5,6	17,3	4,6	26	18	10
E 5	7	17,3	5,2	26	20	10
E 6	8,3	17,3	5,4	26	21	10
E 7	8,9	17,3	6,6	26	22	10
E 8	9,9	17,3	7	26	23	10
E10	12	17,3	8,2	26	24	10
E11	13,3	17,3	8,7	26	25	10
E12	14,5	17,3	9,3	26	26	10
E14	15,8	17,3	10,6	26	27	10
E16	18	17	11,8	26	27	10

TORX® (E)



E	E4	E5	E6	E7	E8	E10	E11	E12	E14	E16	E18	E20	E22	E24	E26	E28
S (ref. mm)	3.83	4.72	5.69	6.17	7.47	9.37	10.03	11.12	12.85	14.71	16.64	18.41	20.24	22.10	23.85	25.65

RS3425/9 Socket Set on Rail Juego de Vasos en Regleta



RS3425/9	9 Pieces Set/Rail 200mm	(g)
E4, E5, E6, E7, E8, E10, E12, E14, E16		239

3425(2B) TORX® Sockets Nut Grip® Vasos TORX® Nut Grip®

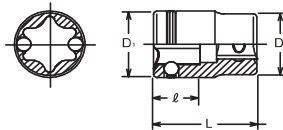

3425 (2B)	D ₁ (mm)	D ₂ (mm)	ℓ (mm)	L (mm)	(g)	(pcs.)
E10	12	17,3	8,2	26	23	10
E12	14,5	17,3	9,3	26	25	10
E14	15,8	17,3	10,6	26	26	10
E16	18,1	17	11,8	26	27	10
E18	19,5	18,5	12	32	41	10
E20	21,9	20	14,4	32	52	10

RS3425/4(2B) Socket Set on Rail Juego de Vasos en Regleta



RS3425/4(2B)	4 Pieces Set/Rail 150mm	(g)
E10, E12, E14, E20		150

3450M Nut Grip Sockets Nut Grip® Vasos Sujeta-tuercas Nut Grip®

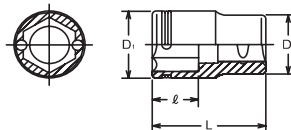

3450M (mm)	D ₁ (mm)	D ₂ (mm)	ℓ (mm)	L (mm)	(g)	(pcs.)
8	12	17,3	5	26	21	10
10	14,5	17,3	6	26	24	10
11	15,8	17,3	6,5	26	26	10
12	16,8	17,3	7	26	26	10
13	18	17	8	26	28	10
14	19,5	18,5	8,5	27	34	10
15	20,8	19,5	9	27	42	10
16	22	20	9	27	50	10
17	23,3	21,5	9,5	28	62	10
18	24,5	22,5	10,5	29	64	10
19	25,8	23,3	11,5	29	66	10
21	28	26	12	29	85	10
22	29,5	27	12,5	29	90	10
24	32	30	14,5	31	102	10

RS3450M/8 Socket Set on Rail Juego de Vasos en Regleta



RS3450M/8	8 Pieces Set/Rail 200mm	(g)
8, 10, 11, 12, 13, 14, 17, 19		310

RS3450M/10 Socket Set on Rail Juego de Vasos en Regleta



RS3450M/10	10 Pieces Set/Rail 250mm	(g)
10, 11, 12, 13, 14, 15, 17, 19, 21, 22		500

3400LH (LH-S)	D ₁ (mm)	D ₂ (mm)	ℓ (mm)	L (mm)	(g)	(pcs.)
5S	10.8	17.3	5	26	20	10
6S	12	17.3	5.6	26	22	10
8S	15.8	17.3	6.8	26	25	10
10S	18	17	8	26	25	10
12S	22	20	9.2	28	42	10
14S	24.5	22.5	10.4	30	51	10
16S	28	26	11.6	32	77	10

RS3400LH/7	7 Pieces Set/Rail 150mm	(g)
5S, 6S, 8S, 10S, 12S, 14S, 16S		315

3300X 3305X (mm)	D ₁ (mm)	D ₂ (mm)	ℓ (mm)	H (mm)	L (mm)	(g)	(pcs.)
8	12	17.3	9	26.5	40	34	10
9	13	17.3	10	26.5	40	36	10
10	14.5	17.3	11	26.5	40	36	10
11	16	17.2	12	26.5	40	36	10
12	16.8	17.2	13	26.5	40	36	10
13	18	17	14	26.5	40	37	10
14	20	18	16	26.5	40	46	10
15	21	20	16	25.5	40	49	10
16	22	20	17	25.5	40	51	10
17	23.5	22	18	25.5	40	61	10
18	24.5	23	19	24.5	40	68	10
19	25	24	20	24.5	40	75	10

3300XA 3305XA (inch)	D ₁ (mm)	D ₂ (mm)	ℓ (mm)	H (mm)	L (mm)	(g)	(pcs.)
1/4	10.3	17.3	7	26.5	40	32	10
5/16	12	17.3	9	26.5	40	34	10
3/8	13.9	17.3	11	26.5	40	36	10
7/16	16	17.2	12	26.5	40	36	10
1/2	18	17	14	26.5	40	37	10
9/16	20	18.5	16	26.5	40	46	10
5/8	22	20	17	25.5	40	51	10
11/16	24.5	22.5	19	24.5	40	68	10
3/4	25	23.5	20	24.5	40	75	10

RS3300X/8	8 Pieces Set/Rail 200mm	(g)
8, 10, 11, 12, 13, 14, 17, 19		405

RS3305X/8	8 Pieces Set/Rail 200mm	(g)
8, 10, 11, 12, 13, 14, 17, 19		405

RS3300XA/9	9 Pieces Set/Rail 200mm	(g)
1/4, 5/16, 3/8, 7/16, 1/2, 9/16, 5/8, 11/16, 3/4		460

RS3305XA/9	9 Pieces Set/Rail 200mm	(g)
1/4, 5/16, 3/8, 7/16, 1/2, 9/16, 5/8, 11/16, 3/4		460

3350X (mm)	D ₁ (mm)	D ₂ (mm)	ℓ (mm)	H (mm)	L (mm)	(g)	(pcs.)
New 8	12	17.4	5	26.5	40	33	10
New 10	14.5	17.4	6	26.5	40	35	10
New 12	16.8	17.2	7	26.5	40	40	10
New 14	19.5	18.5	8.5	26.5	40	48	10

3400LH LHS Sockets Vasos LHS

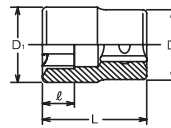

RS3400LH/7 Socket Set on Rail Juego de Vasos en Regleta



3300X • 3300XA 6-point Sockets, Semi-Deep Vasos Hexagonales, Medianos

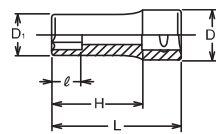

3305X • 3305XA 12-point Sockets, Semi-Deep Vasos Bihexagonales, Medianos

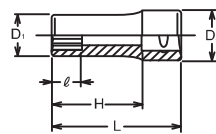

RS3300X/8 Socket Set on Rail Juego de Vasos en Regleta

RS3305X/8



RS3300XA/9 Socket Set on Rail Juego de Vasos en Regleta

RS3305XA/9



3350X Nut Grip® Socket, Semi-Deep Vasos Sujeta-tuercas Nut Grip®. Medianos

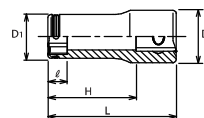

Hand Sockets **3/8"**

3300M • 3300A

 6-point Deep Sockets
Vasos Hexagonales Largos

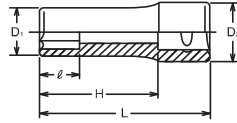

3305M • 3305A

 12-point Deep Sockets
Vasos Bihexagonales Largos

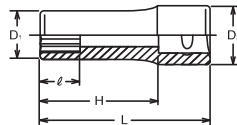

3300M 3305M (mm)	D ₁ (mm)	D ₂ (mm)	ℓ (mm)	H (mm)	L (mm)	⚖️ (g)	📦 (pcs.)
5.5	8.9	17.3	6.5	41.5	55	37	10
6	9.9	17.3	7	41.5	55	37	10
7	10.6	17.3	8	41.5	55	37	10
8	12	17.3	9	41.5	55	40	10
9	13	17.3	10	41.5	55	42	10
10	14.5	17.3	11	41.5	55	46	10
11	16	17.2	12	41.5	55	51	10
12	16.8	17.2	13	41.5	55	52	10
13	18	17	14	41.5	55	53	10
14	20	18	16	41.5	55	60	10
15	21	20	16	40.5	55	74	10
16	22	20	17	40.5	55	76	10
17	23.5	22	18	40.5	55	93	10
18	24.5	23	19	39.5	55	98	10
19	25	24	20	39.5	55	98	10
20	26	25	21	49.5	65	126	10
21	27	26	22	49.5	65	126	10
22	29	28	23	48.5	65	163	10
23	30	29	24	48.5	65	168	10
24	31	30	25	47.5	65	191	10
25	33	30	26	47.5	65	199	10
26	34	31	27	47.5	65	209	10
27	35	32.5	28	47.5	65	218	10

3300A 3305A (inch)	D ₁ (mm)	D ₂ (mm)	ℓ (mm)	H (mm)	L (mm)	⚖️ (g)	📦 (pcs.)
New 7/32	8.9	17.3	6	41.5	55	35	10
1/4	9.9	17.3	7	41.5	55	37	10
5/16	12	17.3	9	41.5	55	40	10
11/32	12.3	17.3	10	41.5	55	41	10
3/8	14	17.3	11	41.5	55	46	10
7/16	16	17.2	12	41.5	55	51	10
1/2	18	17	14	41.5	55	53	10
9/16	20	18	16	41.5	55	60	10
19/32	21	20	16	40.5	55	74	10
5/8	22	20	17	40.5	55	76	10
11/16	23.5	22	18	40.5	55	93	10
3/4	25	24	20	39.5	55	98	10
13/16	27	26	22	49.5	65	126	10
7/8	29	28	23	48.5	65	163	10
15/16	31	30	25	47.5	65	191	10

RS3300M/8

  Socket Set on Rail
Juego de Vasos en Regleta

RS3305M/8



RS3300M/8	8 Pieces Set/Rail 200mm	⚖️ (g)
8, 10, 11, 12, 13, 14, 17, 19		540

RS3305M/8	8 Pieces Set/Rail 200mm	⚖️ (g)
8, 10, 11, 12, 13, 14, 17, 19		540

RS3300M/12

  Socket Set on Rail
Juego de Vasos en Regleta

RS3305M/12



RS3300M/12	12 Pieces Set/Rail 300mm	⚖️ (g)
8, 9, 10, 11, 12, 13, 14, 15, 16, 17, 18, 19		878

RS3305M/12	12 Pieces Set/Rail 300mm	⚖️ (g)
8, 9, 10, 11, 12, 13, 14, 15, 16, 17, 18, 19		878

RS3300A/9

  Socket Set on Rail
Juego de Vasos en Regleta

RS3305A/9

 



RS3300A/9	9 Pieces Set/Rail 200mm	⚖️ (g)
1/4, 5/16, 3/8, 7/16, 1/2, 9/16, 5/8, 11/16, 3/4		628

RS3305A/9	9 Pieces Set/Rail 200mm	⚖️ (g)
1/4, 5/16, 3/8, 7/16, 1/2, 9/16, 5/8, 11/16, 3/4		628

3/8" Hand Sockets

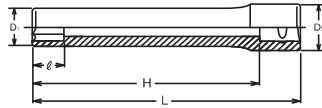

3300M-Size DEEP SOCKET

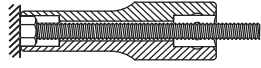

3300M-Size(L120) EXTRA DEEP SOCKET

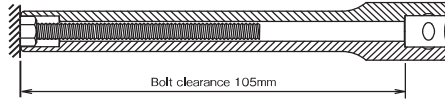

3300M(L120) 3305M(L120) (mm)	D ₁ (mm)	D ₂ (mm)	ℓ (mm)	H (mm)	L (mm)	(g)	(pcs.)
8	12	17.3	9	106.5	120	85	10
10	14.5	17.3	11	106.5	120	110	10
12	16.8	17.2	13	106.5	120	116	10
13	18	17	14	106.5	120	155	5
14	20	18	16	106.5	120	166	5

3300M/4-L120	4 Pieces Set/ΔΣΔ=477g
PLASTIC BAG	
Sockets	
3300M(L120) 6-point Extra Deep Sockets 8, 10, 12, 14	

3305M/4-L120	4 Pieces Set/ΔΣΔ=477g
PLASTIC BAG	
Sockets	
3305M(L120) 12-point Extra Deep Sockets 8, 10, 12, 14	

3310M (mm)	D ₁ (mm)	D ₂ (mm)	ℓ (mm)	H (mm)	L (mm)	(g)	(pcs.)
6	9.9	17.3	7	41.5	55	37	10
7	10.6	17.3	8	41.5	55	37	10
8	12	17.3	9	41.5	55	40	10
9	13	17.3	10	41.5	55	42	10
10	14.5	17.3	11	41.5	55	46	10
11	16	17.2	12	41.5	55	51	10
12	16.8	17.2	13	41.5	55	52	10
13	18	17	14	41.5	55	53	10
14	20	18	16	41.5	55	60	10
15	21	20	16	40.5	55	74	10
16	22	20	17	40.5	55	76	10
17	23.5	22	18	40.5	55	93	10
18	24.5	23	19	39.5	55	98	10
19	25	24	20	39.5	55	98	10
20	26	25	21	49.5	65	126	10
21	27	26	22	49.5	65	126	10
22	29	28	23	48.5	65	163	10
23	30	29	24	48.5	65	168	10
24	31	30	25	47.5	65	161	10

RS3310M/12	12 Pieces Set/Rail 300mm	(g)
8, 9, 10, 11, 12, 13, 14, 15, 16, 17, 18, 19		881

3300M (L120)

6-point Extra Deep Sockets
Vasos Hexagonales Extra-Largos



3305M (L120)

12-point Extra Deep Sockets
Vasos Bihexagonales Extra-Largos



3300M/4-L120

Socket Set
Juego de Vasos

3305M/4-L120



3310M

Surface Drive Deep Sockets
Vasos Surface Drive (de Contacto Curvo) Largos

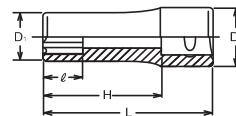

RS3310M/12

Socket Set on Rail
Juego de Vasos en Regleta





HAND MANUALES
Z-SERIES
TITANIUM DE TITANIO
ACCESSORIES ACCESORIOS
SCREWDRIVERS DESTORNILLADORES
IMPACT DE IMPACTO
SLEEVE-DRIVE
INDUSTRIAL INDUSTRIALES
PROTECTOR PROTECTORES
AUTOMOTIVE
CONSTRUCTION CONSTRUCCIÓN
RENEWAL KITS JUEGOS DE PIEZAS REPUESTO

Hand Sockets 3/8"

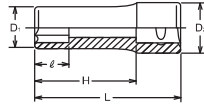
3300W 6-point Deep Whitworth Sockets Vasos Whitworth Hexagonales Largos



3300W 3305W (W)	D ₁ (mm)	D ₂ (mm)	ℓ (mm)	H (mm)	L (mm)	 (g)	 (pcs.)
1/8	12.3	17.3	10	41.5	55	46	10
3/16	16	17.3	12	41.5	55	55	10
1/4	18	17	14	41.5	55	57	10
5/16	21	20	16	40.5	55	79	10
3/8	24.5	23	19	39.5	55	96	10
7/16	27	26	22	49.5	65	140	10
1/2	30	29	24	48.5	65	193	10
9/16	34	31	27	47.5	65	250	10

3305W 12-point Deep Whitworth Sockets Vasos Whitworth Bihexagonales Largos

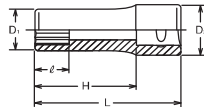

BS W



BS - W	BS	3/16BS	1/4BS	5/16BS	3/8BS	7/16BS	1/2BS	9/16BS	5/8BS	11/16BS	3/4BS	7/8BS
	Across Flat	(ref. mm)	8.64	11.30	13.34	15.24	18.03	20.83	23.37	25.65	27.94	30.48

RS3300W/7 Socket Set on Rail Juego de Vasos en Regleta

RS3305W/7





RS3300W/7	7 Pieces Set/Rail 200mm	 (g)
1/8, 3/16, 1/4, 5/16, 3/8, 7/16, 1/2		719

RS3305W/7	7 Pieces Set/Rail 200mm	 (g)
1/8, 3/16, 1/4, 5/16, 3/8, 7/16, 1/2		719

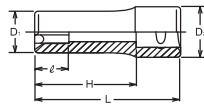
3325 TORX® Deep Sockets Vasos TORX® Largos



3325 (E)	D ₁ (mm)	D ₂ (mm)	ℓ (mm)	H (mm)	L (mm)	 (g)	 (pcs.)
E 4	5.6	17.3	4.6	41.5	55	29	10
E 5	6.9	17.3	5.2	41.5	55	31	10
E 6	7.9	17.3	5.4	41.5	55	33	10
E 7	8.9	17.3	6.6	41.5	55	36	10
E 8	9.9	17.3	7	41.5	55	39	10
E10	11.8	17.3	8.2	41.5	55	43	10
E12	14.5	17.2	9.3	41.5	55	53	10
E14	15.7	17.2	10.6	41.5	55	57	10
E16	18	17	11.8	41.5	55	69	10

TORX® (E)

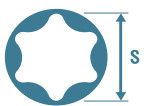

E	E4	E5	E6	E7	E8	E10	E11	E12	E14	E16	E18	E20	E22	E24	E26	E28	
S	(ref. mm)	3.83	4.72	5.69	6.17	7.47	9.37	10.03	11.12	12.85	14.71	16.64	18.41	20.24	22.10	23.85	25.65

RS3325/9 Socket Set on Rail Juego de Vasos en Regleta



RS3325/9	9 Pieces Set/Rail 200mm	 (g)
E4, E5, E6, E7, E8, E10, E12, E14, E16		420

3/8" Hand Sockets

3350M (mm)	D ₁ (mm)	D ₂ (mm)	ℓ (mm)	H (mm)	L (mm)	(g)	(pcs.)
8	12	17.4	5	41.5	55	50	10
10	14.5	17.4	6	41.5	55	54	10
12	16.8	17.2	7	41.5	55	58	10
13	18	17	8	41.5	55	59	10
14	19.5	18.5	8.5	41.5	55	71	10

RS3350M/5	5 Pieces set/Rail 150mm	(g)
8, 10, 12, 13, 14		322

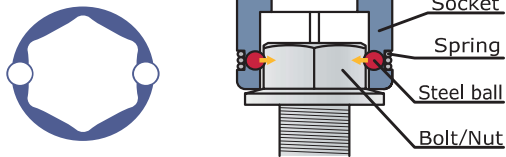

3350M(L120) (mm)	D ₁ (mm)	D ₂ (mm)	ℓ (mm)	H (mm)	L (mm)	(g)	(pcs.)
10	14.5	17.2	6	106.5	120	110	10
12	16.8	17.2	7	106.5	120	116	10

3350M/2-L120	2 Pieces Set/Δ=230g
PLASTIC BAG	
Sockets	
3350M(L120) Nut Grip Extra Deep Sockets	
10, 12	

3300FN (mm)	D ₁ (mm)	D ₂ (mm)	ℓ (mm)	L (mm)	S (mm)	(g)	(pcs.)
8	14.5	17.3	6	53	6.4	38	10
9	16	17.3	7	53	6.8	41	10
10	16.8	17.2	7.5	53	7.2	42	10
11	18	17	8.5	53	8.3	42	10
12	20	18	9	53	8.8	50	10
13	21.1	20	9.5	62	9.4	66	10
14	22	20	10.5	62	10.5	66	10
15	23	22	11	70	11.5	82	10
16	24	23	11.5	70	12	90	10
17	25	24	12.5	80	13	110	10
18	27	25	13	80	13.5	120	10
19	28	26	14	80	14.5	130	10
22	32	29.5	16	80	16	180	10
24	34.5	31.5	17	80	17	200	10

RS3300FN/6	6 Pieces Set/Rail 150mm	(g)
8, 10, 12, 14, 17, 19		450

3350M Nut Grip Deep Sockets Vastos Sujeta-tuercas Largos Nut Grip®



RS3350M/5 Socket Set on Rail Juego de Vasos en Regleta



3350M (L120) Extra Deep Sockets Vastos Extra-Largos Nut Grip®



3350M/2-L120 Socket Set Juego de Vasos



3300FN Flare Nut Sockets Llaves de vaso para entubar

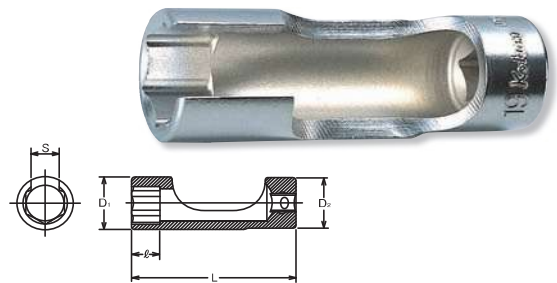

RS3300FN/6 Socket Set on Rail Juego de Vasos en Regleta



HAND MANUALES
Z-SERIES
TITANIUM DE TITANIO
ACCESSORIES ACCESORIOS
SCREWDRIVERS DESTORNILLADORES
IMPACT DE IMPACTO
SLEEVE-DRIVE
INDUSTRIAL INDUSTRIALES
PROTECTOR PROTECTORES
AUTOMOTIVE
CONSTRUCTION CONSTRUCCIÓN
RENEWAL KITS JUEGOS DE PIEZAS REPARACIÓN

Hand Sockets **3/8"**

HAND
MANUALES

Z-SERIES

TITANIUM
DE TITANIO

ACCESSORIES
ACCESORIOS

SCREWDRIVERS
DESTORNILLADORES

IMPACT
DE IMPACTO

SLEEVE-DRIVE

INDUSTRIAL
INDUSTRIALES

PROTECTOR
PROTECTORES



AUTOMOTIVE

CONSTRUCTION
CONSTRUCCIÓN

RENEWAL KITS
JUEGOS DE PIEZAS REFLEJO



3440M • 3440A 6-point Universal Sockets Vasos Hexagonales Universal

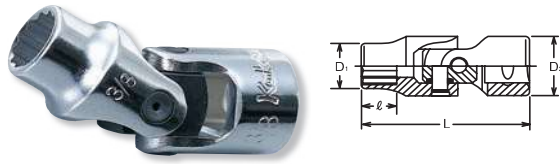

3440M 3445M (mm)	D ₁ (mm)	D ₂ (mm)	ℓ (mm)	L (mm)	 (g)	 (pcs.)
8	12	19	7.3	47	50	10
9	13.3	19	7.8	47.5	50	10
10	14.5	19	8.8	48.5	64	10
11	15.8	19	9.8	49.5	66	10
12	17	19	10.3	50	67	10
13	18.3	19	11.3	51	68	10
14	19.5	19	11.3	51	69	10
15	20.8	19	12.8	53.5	70	10
16	22	19	12.8	53.5	77	10
17	23.3	19	13.8	54.5	80	10
18	24.5	19	13.8	54.5	80	10
19	25.8	19	15.8	56.5	84	10
21	28.3	19	16.8	56.5	96	10

3445M • 3445A 12-point Universal Sockets Vasos Bihexagonales con Articulación Universal



3440A 3445A (inch)	D ₁ (mm)	D ₂ (mm)	ℓ (mm)	L (mm)	 (g)	 (pcs.)
5/16	12	19	7.3	47	50	10
3/8	14	19	8.3	48	64	10
7/16	15.8	19	9.8	49.5	66	10
1/2	18.3	19	11.3	51	68	10
9/16	19.5	19	11.3	51	69	10
5/8	22	19	12.8	53.5	77	10
11/16	24.5	19	13.8	54.5	80	10
3/4	25.8	19	15.8	56.5	84	10

RS3440M/8 Socket Set on Rail Juego de Vasos en Regleta





RS3440M/8	8 Pieces Set/Rail 200mm	 (g)
8, 10, 11, 12, 13, 14, 17, 19		550

RS3440A/8	8 Pieces Set/Rail 200mm	 (g)
5/16, 3/8, 7/16, 1/2, 9/16, 5/8, 11/16, 3/4		570

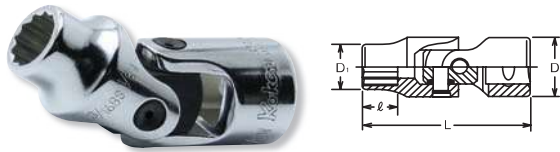
3445W 12-point Whitworth Universal Socket Vasos Whitworth Bihex con Articulación Universal



3445W (W)	D ₁ (mm)	D ₂ (mm)	ℓ (mm)	L (mm)	 (g)	 (pcs.)
1/8	13.3	19	7.8	47.5	50	10
3/16	15.8	19	9.7	49.5	66	10
1/4	18.3	19	11.3	51	68	10
5/16	20.8	19	12.8	53.5	70	10
3/8	24.5	19	13.8	54.5	80	10
7/16	28.3	19	16.8	57.5	96	10
1/2	30.8	19	17.8	58.5	105	10



RS3445W/7 Socket Set on Rail Juego de Vasos en Regleta

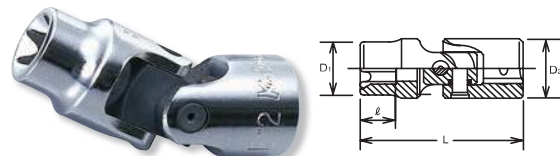

RS3445W/7	7 Pieces Set/Rail 200mm	 (g)
1/8, 3/16, 1/4, 5/16, 3/8, 7/16, 1/2		570

3440T TORX® Universal Sockets Vasos TORX® con Articulación Universal



3440T (E)	D ₁ (mm)	D ₂ (mm)	ℓ (mm)	L (mm)	 (g)	 (pcs.)
E 6	7.9	19	5.4	44.9	60	10
E 8	9.9	19	7	46.5	63	10
E10	11.8	19	8.2	47.7	63	10
E12	14.5	19	9.3	48.8	68	10
E14	15.7	19	10.6	50.1	68	10
E16	18	19	11.8	51.3	70	10
E18	19.5	19	13	53.5	78	10
E20	22	19	14.4	54.9	81	10

RS3440T/8 Socket Set on Rail Juego de Vasos en Regleta



RS3440T/8	8 Pieces Set/Rail 200mm	 (g)
E6, E8, E10, E12, E14, E16, E18, E20		594

3441M (mm)	D ₁ (mm)	D ₂ (mm)	ℓ (mm)	L (mm)	(g)	(pcs.)
8	12	19	5	46	57	10
10	14.5	19	6	46	58	10
12	16.8	19	7	47	58	10
13	18	19	8	48	60	10
14	19.5	19	8.5	49.5	65	10



RS3441M/5	5 Pieces Set/Rail 150mm	(g)
8, 10, 12, 13, 14		320

3340M.75 (mm)	D ₁ (mm)	D ₂ (mm)	ℓ (mm)	H (mm)	L (mm)	(g)	(pcs.)
8	12	19	9	39	75	82	10
10	14.5	19	11	39	75	87	10
11	15.8	19	12	39	75	87	10
12	17	19	13	39	75	92	10
13	18.3	19	14	36	75	93	10
14	19.5	19	15	35	75	103	10
15	20.8	19	16	35	75	104	10
16	22	19	17	34	75	110	10
17	23.3	19	18	34	75	115	10
18	24.5	19	19	34	75	119	10
19	25.8	19	20	33	75	123	10

RS3340M/8-L75	8 Pieces Set/Rail 200mm	(g)
8, 10, 11, 12, 13, 14, 17, 19		810

3430M (mm)	D (mm)	ℓ (mm)	L (mm)	(g)	(pcs.)
5	19	15.5	62	66	10
6	19	15.5	62	70	10
7	19	15.5	62	72	10
8	19	15.5	62	74	10
10	19	15.5	62	78	10
12	19	15.5	62	85	10

RS3430M/6	6 Pieces Set/Rail 150mm	(g)
5, 6, 7, 8, 10, 12		470

3441M Nut Grip Universal Sockets Vasos Sujeta-Tuercas con Articulación Universal

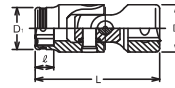

RS3441M/5 Socket Set on Rail Juego de Vasos en Regleta



3340M-75 Universal Deep Sockets Vasos Largos con Articulación Universal

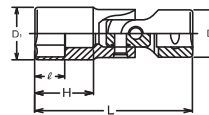

RS3340M/8-L75 Socket Set on Rail Juego de Vasos en Regleta



3430M Universal Inhex Bit Sockets Vasos Inhex con Articulación Universal

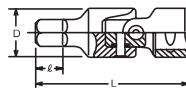



RS3430M/6 Socket Set on Rail Juego de Vasos en Regleta



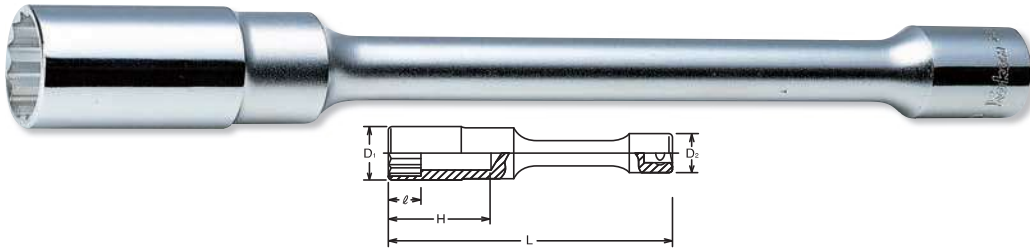

Hand Sockets **3/8"**

3117M-125 · -250 Extension Deep Sockets Vasos con Alargadera





3117M.125 (mm)	D ₁ (mm)	D ₂ (mm)	ℓ (mm)	H (mm)	L (mm)	 (g)	 (pce.)
10	14.5	18	10	44	125	121	1
11	16	18	11	44	125	133	1
12	17	18	12	44	125	133	1
13	18	18	13	44	125	134	1
14	19.5	18	14	44	125	145	1
17	23.5	18	17	44	125	178	1
19	25	18	19	44	125	187	1
21	27	18	21	44	125	195	1
22	29	18	22	44	125	214	1

3117M.250 (mm)	D ₁ (mm)	D ₂ (mm)	ℓ (mm)	H (mm)	L (mm)	 (g)	 (pce.)
10	14.5	18	10	44	250	233	1
11	16	18	11	44	250	241	1
12	17	18	12	44	250	246	1
13	18	18	13	44	250	249	1
14	19.5	18	14	44	250	262	1
17	23.5	18	17	44	250	289	1
19	25	18	19	44	250	298	1
21	27	18	21	44	250	302	1
22	29	18	22	44	250	325	1



3000-60 (PH) Phillips Bit Sockets Vasos con Punta Phillips



3000 (PH)	D (mm)	H (mm)	L (mm)	 (g)	 (pce.)
1	18	33.5	60	49	10
2	18	33.5	60	49	10
3	18	33.5	60	49	10
4	18	33.5	60	50	10



3000-50 (PZ) PZ Bit Sockets Vasos con Punta PZ





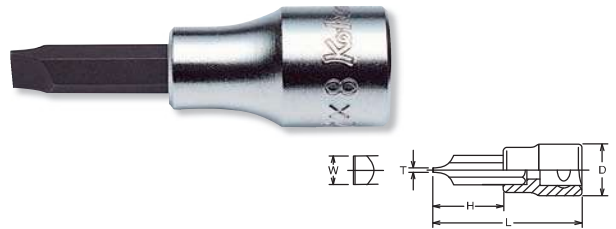







3000.50 (PZ)	D (mm)	H (mm)	L (mm)	 (g)	 (pce.)
PZ1	18	23.5	50	50	10
PZ2	18	23.5	50	50	10
PZ3	18	23.5	50	50	10

3005-60 Slotted Bit Sockets Vasos con Punta Recta para Cabeza Ranurada



3005	T×W (mm)	D (mm)	H (mm)	L (mm)	 (g)	 (pce.)
5	1.0x 5.5	18	33.5	60	47	10
8	1.2x 8	18	33.5	60	49	10
10	1.6x10	20	33.5	60	85	10



	 Phillips (PH)	 PZ	 Slotted	 HEX	 HEX (ball point)	 Triple Square (XZN)	 TORX® (T)	 TORX® (TH)	 TORXplus® (IP)	 Penta-Lobe (PR)	 Ribe-CV
1/4"	No.2000 series	No.2000(PZ) series	No.2005 series	No.2010M/A series	No.2011M series	No.2020 series	No.2025 series	No.2025(TH) series	No.2025(IP) series	No.2025(PR) series	—
3/8"	No.3000 No.3001 series	No.3000(PZ) series	No.3005 No.3006 series	No.3010M/A No.3012M/A No.3015M series	No.3011M series	No.3020 series	No.3025 series	No.3025(TH) series	No.3025(IP) series	No.3025(PR) series	No.3027 series
1/2"	No.4000 No.4001 series	No.4000(PZ) series	No.4005 No.4006 series	No.4010M/A No.4012M/A series	—	No.4020 series	No.4025 series	—	No.4025(IP) series	—	No.4027 series



3/8" Hand Sockets

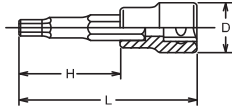

3010M-38 · -62 · -100 · -160
3010A-50



 Inhex Bit Sockets
Vasos con Punta Hexagonal









3010M.38 (mm)	D (mm)	H (mm)	L (mm)	 (g)	 (pcs.)
3	18	11.5	38	27	10
4	18	11.5	38	28	10
5	18	11.5	38	30	10
6	18	11.5	38	31	10
7	18	11.5	38	32	10
8	18	11.5	38	33	10
9	20	11.5	38	47	10
10	20	11.5	38	48	10
11	20	11.5	38	59	10
12	20	11.5	38	60	10
13	22	11.5	38	76	5
14	22	11.5	38	78	5



3010M.62 (mm)	D (mm)	H (mm)	L (mm)	 (g)	 (pcs.)
3	18	35.5	62	43	10
4	18	35.5	62	45	10
5	18	35.5	62	48	10
6	18	35.5	62	49	10
7	18	35.5	62	50	10
8	18	35.5	62	62	10
9	20	35.5	62	75	10
10	20	35.5	62	76	10
11	20	35.5	62	92	10
12	20	35.5	62	94	10
13	22	35.5	62	107	5
14	22	35.5	62	109	5



3010M.100 (mm)	D (mm)	H (mm)	L (mm)	 (g)	 (pcs.)
3	18	73.5	100	58	10
4	18	73.5	100	60	10
5	18	73.5	100	63	10
6	18	73.5	100	64	10
7	18	73.5	100	66	10
8	18	73.5	100	69	10
9	20	73.5	100	100	10
10	20	73.5	100	102	10
11	20	73.5	100	129	10
12	20	73.5	100	131	10
13	22	73.5	100	158	5
14	22	73.5	100	160	5



3010M.160 (mm)	D (mm)	H (mm)	L (mm)	 (g)	 (pcs.)
3	18	133.5	160	84	10
4	18	133.5	160	86	10
5	18	133.5	160	89	10
6	18	133.5	160	90	10
7	18	133.5	160	92	10
8	18	133.5	160	95	10
9	20	133.5	160	125	10
10	20	133.5	160	128	10
11	20	133.5	160	153	10
12	20	133.5	160	157	10
13	22	133.5	160	237	5
14	22	133.5	160	239	5



3010A.50 (inch)	D (mm)	H (mm)	L (mm)	 (g)	 (pcs.)
New 1/8	18	23.5	50	35	10
New 5/32	18	23.5	50	36	10
New 3/16	18	23.5	50	36	10
New 7/32	18	23.5	50	38	10
New 1/4	18	23.5	50	40	10
New 9/32	18	23.5	50	42	10
New 5/16	18	23.5	50	44	10
New 11/32	20	23.5	50	59	10
New 3/8	20	23.5	50	60	10
New 7/16	20	23.5	50	74	10
New 1/2	22	23.5	50	91	5

RS3010M/8-L38	8 Pieces Set/Rail 200mm	 (g)
3, 4, 5, 6, 7, 8, 10, 12		322
RS3010M/8-L62	8 Pieces Set/Rail 200mm	 (g)
3, 4, 5, 6, 7, 8, 10, 12		490
RS3010M/8-L100	8 Pieces Set/Rail 200mm	 (g)
3, 4, 5, 6, 7, 8, 10, 12		645
RS3010A/8-L50	8 Pieces Set/Rail 200mm	 (g)
1/8, 5/32, 3/16, 7/32, 1/4, 5/16, 3/8, 1/2		400

RS3010M/8-L38   Socket Set on Rail
Juego de Vasos en Regleta

RS3010M/8-L62  

RS3010M/8-L100  

RS3010A/8-L50  



New

HAND MANUALES
Z-SERIES
TITANIUM DE TITANIO
ACCESSORIES ACCESORIOS
SCREWDRIVERS DESTORNILLADORES
IMPACT DE IMPACTO
SLEEVE-DRIVE
INDUSTRIAL INDUSTRIALES
PROTECTOR PROTECTORES
AUTOMOTIVE
CONSTRUCTION CONSTRUCCIÓN
RENEWAL KITS JUEGOS DE PIEZAS REPUESTO

Hand Sockets 3/8"

3011M-62 · -100 · -120 · -160

Ballpoint Inhex Sockets
Vasos con Punta de Bola Inhex

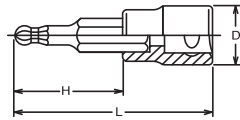

3011M.62 (mm)	D (mm)	H (mm)	L (mm)	(g)	(pcs.)
3	18	35.5	62	45	10
4	18	35.5	62	46	10
5	18	35.5	62	48	10
6	18	35.5	62	49	10
7	18	35.5	62	50	10
8	18	35.5	62	51	10
10	20	35.5	62	66	10
12	20	35.5	62	79	10

3011M.100 (mm)	D (mm)	H (mm)	L (mm)	(g)	(pcs.)
3	18	73.5	100	61	10
4	18	73.5	100	62	10
5	18	73.5	100	64	10
6	18	73.5	100	65	10
7	18	73.5	100	67	10
8	18	73.5	100	68	10

3011M.120 (mm)	D (mm)	H (mm)	L (mm)	(g)	(pcs.)
3	18	93.5	120	77	10
4	18	93.5	120	78	10
5	18	93.5	120	80	10
6	18	93.5	120	81	10
7	18	93.5	120	83	10
8	18	93.5	120	84	10

3011M.160 (mm)	D (mm)	H (mm)	L (mm)	(g)	(pcs.)
3	18	133.5	160	87	10
4	18	133.5	160	88	10
5	18	133.5	160	89	10
6	18	133.5	160	91	10
7	18	133.5	160	93	10
8	18	133.5	160	95	10

Ball point bit sockets have less strength due to the special design. Make sure to use them correctly.

3015M-62 · -100

Inhex Bit Sockets, Grip Ring
Vasos con Punta Hexagonal, Grip Ring

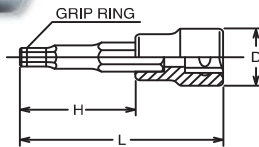

3015M.62 (mm)	D (mm)	H (mm)	L (mm)	(g)	(pcs.)
3	18	35.5	62	43	10
4	18	35.5	62	45	10
5	18	35.5	62	50	10
6	18	35.5	62	50	10
7	18	35.5	62	50	10
8	18	35.5	62	62	10
10	20	35.5	62	75	10
12	20	35.5	62	95	10

3015M.100 (mm)	D (mm)	H (mm)	L (mm)	(g)	(pcs.)
3	18	73.5	100	60	10
4	18	73.5	100	60	10
5	18	73.5	100	65	10
6	18	73.5	100	65	10
7	18	73.5	100	70	10
8	18	73.5	100	70	10
10	20	73.5	100	105	10
12	20	73.5	100	135	10

Grip Ring holds hex screws

RS3015M/8-L62

Socket Set on Rail
Juego de Vasos en Regleta

RS3015M/8-L100



RS3015M/8-L62	8 Pieces Set/Rail 200mm	(g)
3, 4, 5, 6, 7, 8, 10, 12		500

RS3015M/8-L100	8 Pieces Set/Rail 200mm	(g)
3, 4, 5, 6, 7, 8, 10, 12		650

3/8" Hand Sockets

3020-38 · -50 · -100 · -120  XZN Bit Sockets
Vasos con punta XZN

3020.38 (XZN)	D (mm)	H (mm)	L (mm)	(g)	(pcs.)
M 5	18	11.5	38	32	10
M 6	18	11.5	38	33	10
M 8	18	11.5	38	36	10
M10	20	11.5	38	51	10
M12	20	11.5	38	52	10
M14	22	11.5	38	74	10

3020.50 (XZN)	D (mm)	H (mm)	L (mm)	(g)	(pcs.)
M 4	18	23.5	50	35	10
M 5	18	23.5	50	37	10
M 6	18	23.5	50	39	10
M 8	18	23.5	50	40	10
M10	20	23.5	50	65	10
M12	20	23.5	50	69	10
M14	22	23.5	50	75	10

3020.100 (XZN)	D (mm)	H (mm)	L (mm)	(g)	(pcs.)
M 4	18	73.5	100	57	10
M 5	18	73.5	100	59	10
M 6	18	73.5	100	61	10
M 8	18	73.5	100	62	10
M10	20	73.5	100	99	10
M12	20	73.5	100	103	10
M14	22	73.5	100	145	5

3020.120 (XZN)	D (mm)	H (mm)	L (mm)	(g)	(pcs.)
M 4	18	93.5	120	77	10
M 5	18	93.5	120	79	10
M 6	18	93.5	120	81	10
M 8	18	93.5	120	82	10
M10	20	93.5	120	119	10
M12	20	93.5	120	123	10
M14	22	93.5	120	165	5

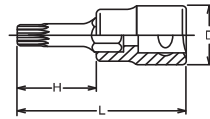
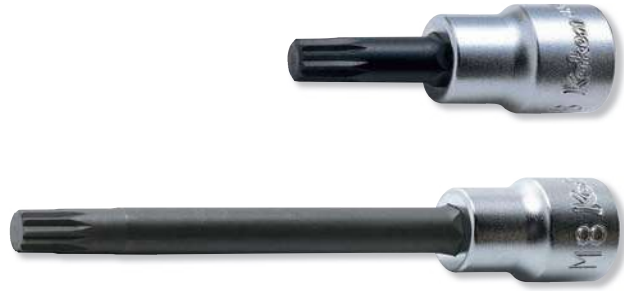

XZN



XZN		M4	M5	M6	M8	M10	M12	M14	M16	M18
S	(ref. mm)	3.60	4.80	6.00	7.20	9.60	11.41	13.22	15.63	16.85

RS3020/6-L38	6 Pieces Set/Rail 150mm	(g)
M5, M6, M8, M10, M12, M14		308

RS3020/6-L38  Socket Set on Rail
Juego de Vasos en Regleta



RS3020/7-L50	7 Pieces Set/Rail 200mm	(g)
M4, M5, M6, M8, M10, M12, M14		400

RS3020/7-L50  Socket Set on Rail
Juego de Vasos en Regleta



HAND
MANUALES
Z-SERIES
TITANIUM
DE TITANIO
ACCESSORIES
ACCESORIOS
SCREWDRIVERS
DESTORNILLADORES
IMPACT
DE IMPACTO
SLEEVE-DRIVE
INDUSTRIAL
INDUSTRIALES
PROTECTOR
PROTECTORES
AUTOMOTIVE
CONSTRUCTION
CONSTRUCCIÓN
RENEWAL KITS
JUEGOS DE PIEZAS REPUESTO

Hand Sockets **3/8"**

3025-38 · -50 · -140 (T)

 TORX® Bit Sockets
Vasos con Punta TORX®

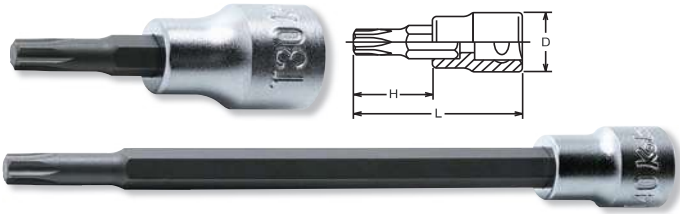

3025.38 (T)	D (mm)	H (mm)	L (mm)	(g)	(pcs.)
T 9	18	11.5	38	32	10
T10	18	11.5	38	32	10
T15	18	11.5	38	33	10
T20	18	11.5	38	33	10
T25	18	11.5	38	33	10
T27	18	11.5	38	33	10
T30	18	11.5	38	33	10
T40	18	11.5	38	34	10
T45	18	11.5	38	37	10
T50	20	11.5	38	49	10
T55	20	11.5	38	57	10

3025.50 (T)	D (mm)	H (mm)	L (mm)	(g)	(pcs.)
T 9	18	23.5	50	36	10
T10	18	23.5	50	36	10
T15	18	23.5	50	36	10
T20	18	23.5	50	36	10
T25	18	23.5	50	37	10
T27	18	23.5	50	37	10
T30	18	23.5	50	38	10
T40	18	23.5	50	39	10
T45	18	23.5	50	41	10
T50	20	23.5	50	55	10
T55	20	23.5	50	67	10

3025.140 (T)	D (mm)	H (mm)	L (mm)	(g)	(pcs.)
T 9	18	113.5	140	75	10
T10	18	113.5	140	75	10
T15	18	113.5	140	75	10
T20	18	113.5	140	75	10
T25	18	113.5	140	76	10
T27	18	113.5	140	76	10
T30	18	113.5	140	77	10
T40	18	113.5	140	78	10
T45	18	113.5	140	80	10
T50	20	113.5	140	94	10
T55	20	113.5	140	106	10

TORX® (T)



T	T8	T9	T10	T15	T20	T25	T27	T30	T40	T45	T50	T55	T60	T70	T80	T90	T100
S (ref. mm)	2.30	2.48	2.72	3.26	3.84	4.40	4.96	5.49	6.60	7.77	8.79	11.17	13.20	15.49	17.51	19.88	22.09

RS3025/8-L38

 Socket Set on Rail
Juego de Vasos en Regleta

RS3025/8-L50





RS3025/8-L38	8 Pieces Set/Rail 200mm	(g)
T10, T15, T20, T25, T27, T30, T40, T45		300

RS3025/8-L50	8 Pieces Set/Rail 200mm	(g)
T10, T15, T20, T25, T27, T30, T40, T45		320

3025-50-T35

 Bit Socket
Vasos con Punta



3025.50 (T)	D (mm)	H (mm)	L (mm)	(g)	(pcs.)
T35	18	23.5	50	39	10

3025-100R (T)

 TORX® Bit Sockets, Round Shaft
Vasos con Punta TORX®

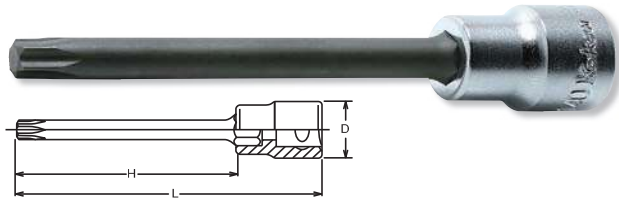

3025.100R (T)	D (mm)	H (mm)	L (mm)	(g)	(pcs.)
T20	18	73.5	100	38	10
T25	18	73.5	100	40	10
T27	18	73.5	100	42	10
T30	18	73.5	100	45	10
T40	18	73.5	100	52	10
T45	18	73.5	100	73	10
T50	20	73.5	100	80	10
T55	20	73.5	100	106	10

RS3025/8-L100R

 Socket Set on Rail
Juego de Vasos en Regleta



RS3025/8-L100R	8 Pieces Set/Rail 200mm	(g)
T20, T25, T27, T30, T40, T45, T50, T55		490

3025.50 (TH)	D (mm)	H (mm)	L (mm)	(g)	(pcs.)
T10H	18	23.5	50	37	10
T15H	18	23.5	50	38	10
T20H	18	23.5	50	38	10
T25H	18	23.5	50	38	10
T27H	18	23.5	50	38	10
T30H	18	23.5	50	39	10
T40H	18	23.5	50	40	10
T45H	18	23.5	50	41	10
T50H	20	23.5	50	61	10
T55H	20	23.5	50	61	10

3025.160 (TH)	D (mm)	H (mm)	L (mm)	(g)	(pcs.)
T25H	18	133.5	160	83	10
T27H	18	133.5	160	83	10
T30H	18	133.5	160	84	10
T40H	18	133.5	160	85	10
T45H	18	133.5	160	86	10
T50H	20	133.5	160	128	10
T55H	20	133.5	160	128	10

RS3025/9-HOLE	9 Pieces Set/Rail 200mm	(g)
T10H, T15H, T20H, T25H, T27H, T30H, T40H, T45H, T50H		405

3247	4 Pieces Set/385g
PLASTIC BAG	
Sockets	
3025.160 Tamper-Resistant TORX® Bit Sockets T27H, T30H, T40H, T50H	

3025.100R (TH)	D (mm)	H (mm)	L (mm)	(g)	(pcs.)
T20H	18	73.5	100	38	10
T25H	18	73.5	100	40	10
T27H	18	73.5	100	42	10
T30H	18	73.5	100	45	10
T40H	18	73.5	100	52	10
T45H	18	73.5	100	73	10
T50H	20	73.5	100	80	10
T55H	20	73.5	100	106	10

RS3025/8-L100RH	8 Pieces Set/Rail 200mm	(g)
T20H, T25H, T27H, T30H, T40H, T45H, T50H, T55H		490

3025-50 · -160 (TH) ⚠

Tamper-Resistant TORX® Bit Sockets
Vasos con Punta TORX® Indeflexible

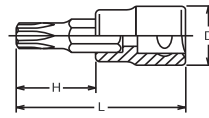

⚠ Tamper Resistant TORX® Bit Sockets have less strength due to special design. Make sure to use it correctly.
Los Vasos con Punta Indeflexible TORX® tienen menos resistencia debido al diseño especial. Asegurarse de su correcta utilización.



RS3025/9-HOLE Socket Set on Rail Juego de Vasos en Regleta



3247 Bit Socket Set Juego de Vasos con Punta



3025-100R (TH) Tamper-Resistant TORX® Bit Sockets, Round Shaft Vasos con Punta TORX® Indeflexible

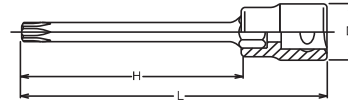

RS3025/8-L100RH Socket Set on Rail Juego de Vasos en Regleta



Hand Sockets 3/8"

3025-50 (IP)

 TORX PLUS® Bit Sockets
Vasos con Punta TORX PLUS®



3025.50 (IP)	D (mm)	H (mm)	L (mm)	(g)	(pcs.)
10IP	18	23.5	50	38	10
15IP	18	23.5	50	38	10
20IP	18	23.5	50	38	10
25IP	18	23.5	50	38	10
27IP	18	23.5	50	40	10
30IP	18	23.5	50	40	10
40IP	18	23.5	50	41	10
45IP	18	23.5	50	41	10
50IP	20	23.5	50	61	10
55IP	20	23.5	50	61	10

TORXplus® (IP)



IP	8IP	9IP	10IP	15IP	20IP	25IP	27IP	30IP	40IP	45IP	50IP	55IP	60IP	70IP
S (ref. mm)	2.29	2.48	2.72	3.25	3.84	4.39	4.95	5.49	6.60	7.77	8.79	11.16	13.20	15.49

RS3025/8-IP

 Socket Set on Rail
Juego de Vasos en Regleta



RS3025/8-IP	8 Pieces Set/Rail 200mm	(g)
20IP, 25IP, 27IP, 30IP, 40IP, 45IP, 50IP, 55IP		370

RSX025/11-IP

 Socket Set on Rail
Juego de Vasos en Regleta



RSX025/11-IP	11 Pieces Set/Rail 200mm	(g)
2025.28(IP)	10IP, 15IP, 20IP, 25IP, 27IP	480
3025.50(IP)	30IP, 40IP, 45IP, 50IP	
4025.60(IP)	55IP, 60IP	
$1/4" + 3/8" + 1/2"$		

3025-50 (PR)

 Penta-Lobe Bit Sockets, with Hole
Vasos con Punta de Cinco Lóbulos, con agujero



3025.50 (PR)	D (mm)	H (mm)	L (mm)	(g)	(pcs.)
10PR	18	23.5	50	38	10
15PR	18	23.5	50	38	10
20PR	18	23.5	50	38	10
25PR	18	23.5	50	38	10
27PR	18	23.5	50	40	10
30PR	18	23.5	50	40	10
40PR	18	23.5	50	41	10
45PR	18	23.5	50	41	10
50PR	20	23.5	50	61	10
55PR	20	23.5	50	61	10

Penta-Lobe (PR)



PR	8PR	9PR	10PR	15PR	20PR	25PR	27PR	30PR	40PR	45PR	50PR	55PR
S (ref. mm)	2.19	2.36	2.58	3.10	3.64	4.12	4.71	5.23	6.30	7.38	8.35	10.63

RS3025/9-PR

 Socket Set on Rail
Juego de Vasos en Regleta



RS3025/9-PR	9 Pieces Set/Rail 200mm	(g)
10PR, 15PR, 20PR, 25PR, 27PR, 30PR, 40PR, 45PR, 50PR		395

RSX025/11-PR

 Socket Set on Rail
Juego de Vasos en Regleta



RSX025/11-PR	11 Pieces Set/Rail 200mm	(g)
2025.28(PR)	8PR, 10PR, 15PR, 20PR, 25PR, 27PR, 30PR	320
3025.50(PR)	40PR, 45PR, 50PR, 55PR	
$1/4" + 3/8"$		

3/8" Hand Sockets

3027.50	D (mm)	H (mm)	L (mm)	(g)	(pcs.)
M 5	18	23.5	50	38	10
M 6	18	23.5	50	38	10
M 7	18	23.5	50	38	10
M 8	18	23.5	50	39	10
M 9	20	23.5	50	40	10
M10	20	23.5	50	40	10
M12	20	23.5	50	41	10

3027.100	D (mm)	H (mm)	L (mm)	(g)	(pcs.)
M 5	18	73.5	100	40	10
M 6	18	73.5	100	42	10
M 8	18	73.5	100	45	10
M10	20	73.5	100	52	10
M12	20	73.5	100	73	10

3027-50 • -100 Bit Sockets for Ribe Screws Vasos con Punta Ribe

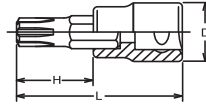

Ribe CV

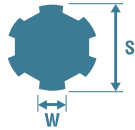

CV		M5	M6	M7	M8	M9	M10	M12	M13	M14	M16
S	(ref. mm)	5	6	7	8	9	10	12	13	14	16
W	(ref. mm)	1.1	1.3	1.4	1.7	1.9	2.2	2.6	3.0	3.1	3.5

RS3027/5-L50	5 Pieces Set/Rail 150mm	(g)
M5, M6, M8, M10, M12		240

RS3027/5-L50 Socket Set on Rail Juego de Vasos en Regleta



3001 (PH)	D (mm)	H (mm)	L (mm)	(g)	(pcs.)
2	18	42	60	38	10
3	18	42	60	38	10
4	18	42	60	38	10

3001 Phillips Bit Sockets Vasos con Punta Phillips

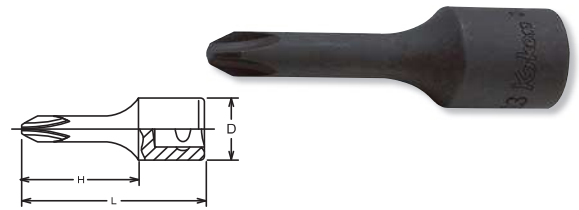

3006	T×W (mm)	D (mm)	H (mm)	L (mm)	(g)	(pcs.)
5	1.0× 5	18	42	60	35	10
8	1.2× 8	18	42	60	42	10
10	1.6×10	20	42	60	50	10

3006 Slotted Bit Sockets Vasos con Punta Recta para Cabeza Ranurada

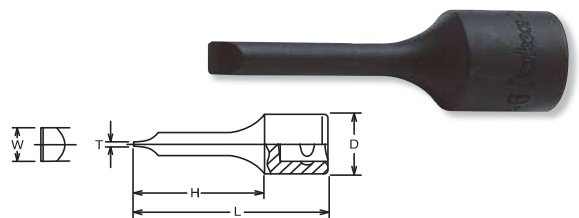

 3001, 3006 are for hand use only.
Do not use with a power or impact wrench.

HAND
MANUALES
Z-SERIES
TITANIUM
DE TITANIO
ACCESORIES
ACCESORIOS
DESTORNILLADORES
Screwdrivers
DE IMPACTO
IMPACT
SLEEVE-DRIVE
INDUSTRIAL
INDUSTRIALES
PROTECTOR
PROTECTORES
AUTOMOTIVE
CONSTRUCTION
CONSTRUCCIÓN
RENEWAL KITS
JUEGOS DE PIEZAS REPUESTO

Hand Sockets **3/8"**

3012M-52 • -62 • -75
3012A-52 • -62 • -75

 Inhex Sockets
 Vasos con Punta de Hexagonal 

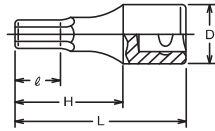

 3012M/A are for hand use only.
 Do not use with a power or impact wrench.

3012M.52 (mm)	D (mm)	ℓ (mm)	H (mm)	L (mm)	(g)	(pcs.)
3	18	10	34	52	35	10
4	18	15.5	34	52	38	10
5	18	15.5	34	52	40	10
6	18	15.5	34	52	42	10
7	18	15.5	34	52	46	10
8	18.5	15.5	34	52	50	10
9	18.5	15.5	34	52	55	10
10	20	15.5	34	52	66	10
11	20	15.5	34	52	72	10
12	20	15.5	34	52	77	10
13	20	15.5	34	52	82	10
14	20	15.5	34	52	89	10

3012A.52 (inch)	D (mm)	ℓ (mm)	H (mm)	L (mm)	(g)	(pcs.)
1/8	18	10	34	52	35	10
5/32	18	15.5	34	52	38	10
3/16	18	15.5	34	52	40	10
7/32	18	15.5	34	52	42	10
1/4	18	15.5	34	52	44	10
9/32	18	15.5	34	52	46	10
5/16	18.5	15.5	34	52	50	10
11/32	18.5	15.5	34	52	55	10
3/8	20	15.5	34	52	65	10
7/16	20	15.5	34	52	72	10
1/2	20	15.5	34	52	82	10
9/16	20	15.5	34	52	89	10

3012M.62 (mm)	D (mm)	ℓ (mm)	H (mm)	L (mm)	(g)	(pcs.)
3	18	10	44	62	38	10
4	18	15.5	44	62	40	10
5	18	15.5	44	62	43	10
6	18	15.5	44	62	46	10
7	18	15.5	44	62	53	10
8	18.5	15.5	44	62	58	10
9	18.5	15.5	44	62	63	10
10	20	15.5	44	62	77	10
11	20	15.5	44	62	83	10
12	20	15.5	44	62	90	10
13	20	15.5	44	62	95	10
14	20	15.5	44	62	109	10

3012A.62 (inch)	D (mm)	ℓ (mm)	H (mm)	L (mm)	(g)	(pcs.)
1/8	18	10	44	62	38	10
5/32	18	15.5	44	62	40	10
3/16	18	15.5	44	62	43	10
7/32	18	15.5	44	62	46	10
1/4	18	15.5	44	62	48	10
9/32	18	15.5	44	62	53	10
5/16	18.5	15.5	44	62	58	10
11/32	18.5	15.5	44	62	63	10
3/8	20	15.5	44	62	73	10
7/16	20	15.5	44	62	83	10
1/2	20	15.5	44	62	95	10
9/16	20	15.5	44	62	109	10

3012M.75 (mm)	D (mm)	ℓ (mm)	H (mm)	L (mm)	(g)	(pcs.)
3	18	10	57	75	41	10
4	18	15.5	57	75	43	10
5	18	15.5	57	75	48	10
6	18	15.5	57	75	53	10
7	18	15.5	57	75	58	10
8	18.5	15.5	57	75	72	10
9	18.5	15.5	57	75	92	10
10	20	15.5	57	75	114	10
11	20	15.5	57	75	120	10
12	20	15.5	57	75	127	10
13	20	15.5	57	75	132	10
14	20	15.5	57	75	146	10

3012A.75 (inch)	D (mm)	ℓ (mm)	H (mm)	L (mm)	(g)	(pcs.)
1/8	18	10	57	75	41	10
5/32	18	15.5	57	75	43	10
3/16	18	15.5	57	75	48	10
7/32	18	15.5	57	75	53	10
1/4	18	15.5	57	75	58	10
9/32	18	15.5	57	75	58	10
5/16	18.5	15.5	57	75	72	10
11/32	18.5	15.5	57	75	92	10
3/8	20	15.5	57	75	110	10
7/16	20	15.5	57	75	120	10
1/2	20	15.5	57	75	132	10
9/16	20	15.5	57	75	146	10

RS3012M/8-L52
RS3012A /8-L52

 Socket Set on Rail
 Juego de Vasos en Regleta



RS3012M/8-L52	8 Pieces Set/Rail 200mm	(g)
3, 4, 5, 6, 7, 8, 10, 12		394

RS3012A/8-L52	8 Pieces Set/Rail 200mm	(g)
1/8, 5/32, 3/16, 7/32, 1/4, 5/16, 3/8, 1/2		425

3/8" Hand Sockets

HAND MANUALES
Z-SERIES
TITANIUM DE TITANIO
ACCESSORIES ACCESORIOS
SCREWDRIVERS DESTORNILLADORES
IMPACT DE IMPACTO
SLEEVE-DRIVE
INDUSTRIAL INDUSTRIALES
PROTECTOR PROTECTORES
AUTOMOTIVE
CONSTRUCTION CONSTRUCCION
RENEWAL KITS JUEGOS DE REZAS REPUESTO



* Renewal Kits → 2749RK-3/8 → P286

	D (mm)	T (mm)	H (mm)	L (mm)	(g)	(pcs.)
2749PS-3/8	25	21.9	11.2	75	70	10

2749PS-3/8 Reversible Ratchet Short Llave de Carraca Reversible Corta ⚠

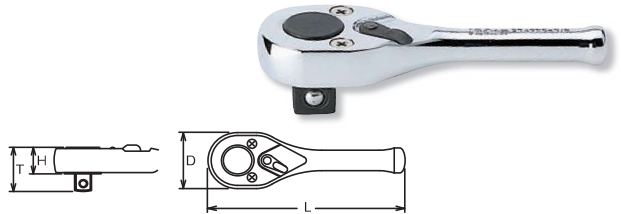

* Renewal Kits → 2749RK-3/8 → P286

	D (mm)	T (mm)	H (mm)	L (mm)	(g)	(pcs.)
2749N-3/8	25	21.9	11.2	125	104	10
2749P-3/8	25	21.9	11.2	125	101	10

⚠ 2749-3/8 series have less strength compared with normal 3/8" ratchet due to the technical design. Make sure to use the ratchet correctly.

2749N-3/8 Reversible Ratchet Llave de Carraca Reversible ⚠



2749P-3/8 Reversible Ratchet Llave de Carraca Reversible ⚠

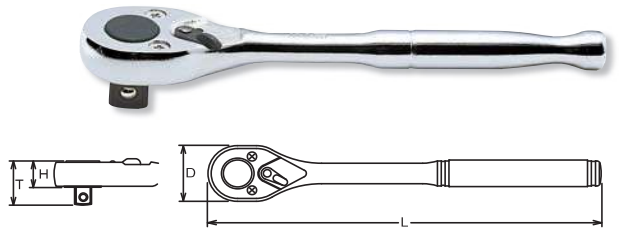

* Renewal Kits → 2749RK-3/8 → P286

3749S Reversible Ratchet Short Llave de Carraca Reversible Corta



* Renewal Kits → 3749RK → P286

3749SB Reversible Ratchet with Quick Release Button Short Llave de Carraca Reversible con botón de extracción rápida Corta ⚠



* Renewal Kits → 3749BRK → P286

	D (mm)	T (mm)	H (mm)	L (mm)	(g)	(pcs.)
3749S	34	24.8	14.1	110	183	5
3749SB	34	24.8	14.1	110	183	5

⚠ Reversible Ratchet with quick release button has less strength compared with normal ratchet due to the technical design. Make sure to use the ratchet correctly.

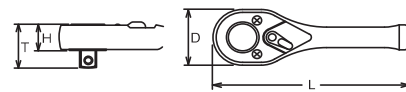

3749N Reversible Ratchet Llave de Carraca Reversible



* Renewal Kits → 3749RK → P286

	D (mm)	T (mm)	H (mm)	L (mm)	(g)	(pcs.)
3749N	34	24.8	14.1	200	340	1

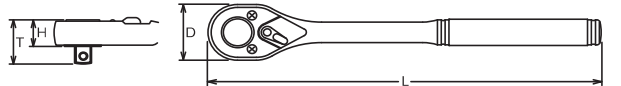

Hand Sockets **3/8"**

HAND
MANUALES

Z-SERIES

TITANIUM
DE TITANIO

ACCESSORIES
ACCESORIOS

SCREWDRIVERS
DESTORNILLADORES

IMPACT
DE IMPACTO

SLEEVE-DRIVE

INDUSTRIAL
INDUSTRIALES

PROTECTOR
PROTECTORES

AUTOMOTIVE

CONSTRUCTION
CONSTRUCCIÓN

RENEWAL KITS
JUEGOS DE PIEZAS REEMPLAZO

3752N Reversible Ratchet Llave de Carraca Reversible



* Renewal Kits → 3752RK → P286



[L/R Marking]



A pointer and L/R markings on the ratchet head indicate the turning direction. The reduced diameter of the head allows easier access in tight spots.

Una flecha y unas marcas L/R en el cabezal de la llave (L = Izquierda / R = Derecha) indican el sentido de giro. El diámetro reducido del cabezal permite un acceso más fácil en lugares estrechos.

3752J Reversible Ratchet Llave de Carraca Reversible



* Renewal Kits → 3752RK → P286

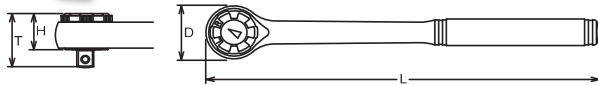

	D (mm)	T (mm)	H (mm)	L (mm)	(g)	(pce.)
3752N	33	34.3	23.9	200	310	1
3752J	33	34.3	23.9	200	310	1

3776N Swivel Head Ratchet Llave de Carraca de Cabeza Giratoria



* Renewal Kits → 3752RK → P286



3776P Swivel Head Ratchet Llave de Carraca de Cabeza Giratoria



* Renewal Kits → 3752RK → P286



3776J Swivel Head Ratchet Llave de Carraca de Cabeza Giratoria



* Renewal Kits → 3752RK → P286

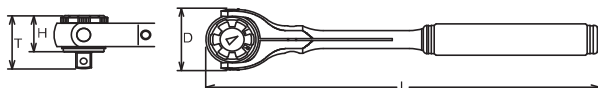

	D (mm)	T (mm)	H (mm)	L (mm)	(g)	(pce.)
3776N	44	34.3	23.9	280	565	1
3776P	44	34.3	23.9	280	560	1
3776J	44	34.3	23.9	280	510	1



* Renewal Kits → 3753RK → P286

	D (mm)	T (mm)	H (mm)	L (mm)	(g)	(pcs.)
3753SM	30.5	26.4	15.7	81	175	5



3753SM Multi Purpose Ratchet, Reversible
Llave de Carraca de Aplicación General, Reversible

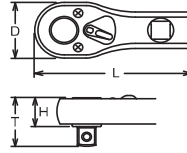

* Renewal Kits → 3753RK → P286



3753N Reversible Ratchet
Llave de Carraca Reversible



* Renewal Kits → 3753RK → P286



3753P Reversible Ratchet
Llave de Carraca Reversible



* Renewal Kits → 3753RK → P286



3753J Reversible Ratchet
Llave de Carraca Reversible



* Renewal Kits → 3753RK → P286



D3753J Reversible Ratchet
Llave de Carraca Reversible

	D (mm)	T (mm)	H (mm)	L (mm)	(g)	(pcs.)
3753N	30.5	26.4	15.7	200	320	1
3753P	30.5	26.4	15.7	200	286	1
3753J	30.5	26.4	15.7	200	260	1
D3753J	30.5	26.4	15.7	200	260	1

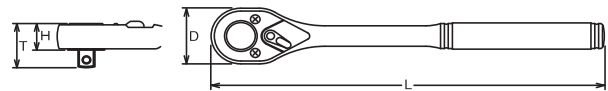

* Renewal Kits → 3753RK → P286



3753P-250 Reversible Ratchet Long
Llave de Carraca Reversible Larga

	D (mm)	T (mm)	H (mm)	L (mm)	(g)	(pcs.)
3753P-250	30.5	26.4	15.7	250	335	1

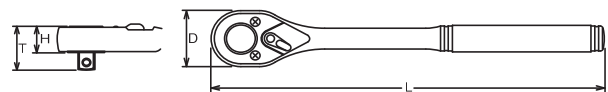

Hand Sockets **3/8"**

HAND
MANUALES

Z-SERIES

TITANIUM
DE TITANIO

ACCESSORIES
ACCESORIOS

SCREWDRIVERS
DESTORNILLADORES

IMPACT
DE IMPACTO

SLEEVE-DRIVE

INDUSTRIAL
INDUSTRIALES

PROTECTOR
PROTECTORES

AUTOMOTIVE

CONSTRUCTION
CONSTRUCCIÓN

RENEWAL KITS
JUEGOS DE PIEZAS REPUESTO

3753SMB Multi Purpose Ratchet with Quick Release Button Llave de Carraca de Aplicación General, reversible

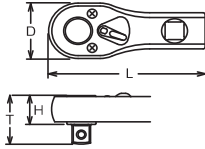

* Renewal Kits → 3753BRK → P286



	D (mm)	T (mm)	H (mm)	L (mm)	(g)	(pcs.)
3753SMB	30.5	26.4	15.7	81	175	5

3753NB Reversible Ratchet with Quick Release Button Llave de Carraca Reversible con botón de extracción rápida



* Renewal Kits → 3753BRK → P286

3753PB Reversible Ratchet with Quick Release Button Llave de Carraca Reversible con botón de extracción rápida



* Renewal Kits → 3753BRK → P286

3753JB Reversible Ratchet with Quick Release Button Llave de Carraca Reversible con botón de extracción rápida



* Renewal Kits → 3753BRK → P286

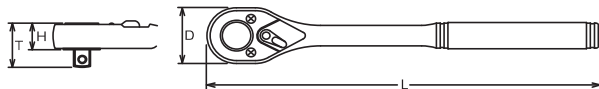

	D (mm)	T (mm)	H (mm)	L (mm)	(g)	(pcs.)
3753NB	30.5	26.4	15.7	200	320	1
3753PB	30.5	26.4	15.7	200	286	1
3753JB	30.5	26.4	15.7	200	260	1

Reversible Ratchet with quick release button has less strength compared with normal ratchet due to the technical design. Make sure to use the ratchet correctly.

3/8" Hand Sockets

HAND
MANUALES
Z-SERIES
TITANIUM
DE TITANIO
ACCESSORIES
ACCESORIOS
SCREWDRIVERS
DESTORNILLADORES
IMPACT
DE IMPACTO
SLEEVE-DRIVE
INDUSTRIAL
INDUSTRIALES
PROTECTOR
PROTECTORES
AUTOMOTIVE
CONSTRUCTION
CONSTRUCCIÓN
RENEWAL KITS
JUEGOS DE PIEZAS REPUESTO



* Renewal Kits → 2749RK-3/8 → P286

2774PS-3/8 Flexible Ratchet, Reversible
Llave de Carraca Flexible, Reversible ⚠



* Renewal Kits → 2749RK-3/8 → P286

2774JS-3/8 Flexible Ratchet, Reversible
Llave de Carraca Flexible, Reversible ⚠

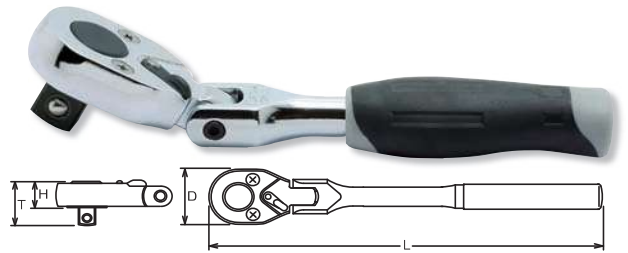

	D (mm)	T (mm)	H (mm)	L (mm)	△ (g)	◇ (pcs.)
2774PS-3/8	25	21.9	11.2	120	133	5
2774JS-3/8	25	21.9	11.2	120	113	5

⚠ 2774-3/8 series have less strength compared with normal (38T) ratchet due to the technical design. Make sure to use the ratchet correctly.



* Renewal Kits → 3753RK → P286

3774PS Flexible Ratchet, Reversible
Llave de Carraca Flexible, Reversible



	D (mm)	T (mm)	H (mm)	L (mm)	△ (g)	◇ (pcs.)
3774PS	30.5	26.4	15.7	175	250	2

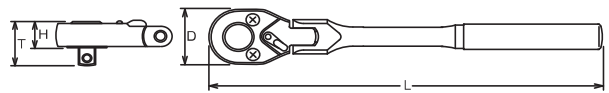

* Renewal Kits → 3753RK → P286

3774N Flexible Ratchet, Reversible
Llave de Carraca Flexible, Reversible

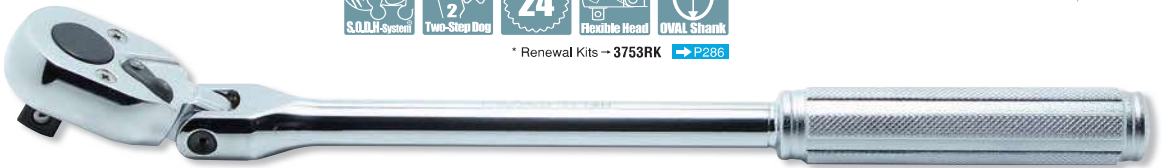

* Renewal Kits → 3753RK → P286

3774P Flexible Ratchet, Reversible
Llave de Carraca Flexible, Reversible



* Renewal Kits → 3753RK → P286

3774J Flexible Ratchet, Reversible
Llave de Carraca Flexible, Reversible



	D (mm)	T (mm)	H (mm)	L (mm)	△ (g)	◇ (pcs.)
3774N	30.5	26.4	15.7	265	378	2
3774P	30.5	26.4	15.7	265	378	2
3774J	30.5	26.4	15.7	285	367	1

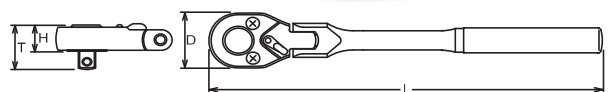

Hand Sockets **3/8"**

HAND
MANUALES

Z-SERIES

TITANIUM
DE TITANIO

ACCESSORIES
ACCESORIOS

SCREWDRIVERS
DESTORNILLADORES

IMPACT
DE IMPACTO

SLEEVE-DRIVE

INDUSTRIAL
INDUSTRIALES

PROTECTOR
PROTECTORES

AUTOMOTIVE

CONSTRUCTION
CONSTRUCCIÓN

RENEWAL KITS
JUEGOS DE PIEZAS REPUESTO

3774P-SR Speeder Ratchet



* Renewal Kits → 3753RK → P286

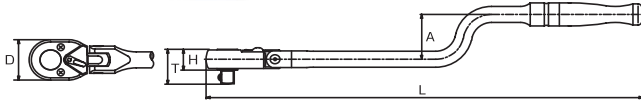

	D (mm)	T (mm)	H (mm)	A (mm)	L (mm)	(g)	(pcs.)
3774P-SR	30.5	26.4	15.7	34	310	435	1

3774NB Flexible Ratchet, Reversible with Quick Release Button

Llave de Carraca Flexible, reversible con botón de extracción rápida



* Renewal Kits → 3753BRK → P286



3774PB Flexible Ratchet, Reversible with Quick Release Button

Llave de Carraca Flexible, reversible con botón de extracción rápida



* Renewal Kits → 3753BRK → P286



3774JB Flexible Ratchet, Reversible with Quick Release Button

Llave de Carraca Flexible, reversible con botón de extracción rápida



* Renewal Kits → 3753BRK → P286

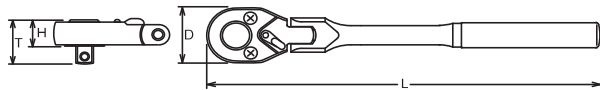

	D (mm)	T (mm)	H (mm)	L (mm)	(g)	(pcs.)
3774NB	30.5	26.4	15.7	265	378	2
3774PB	30.5	26.4	15.7	265	373	2
3774JB	30.5	26.4	15.7	285	367	1

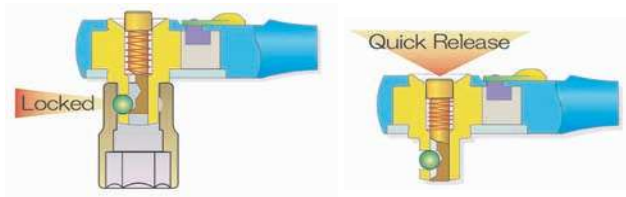

Reversible Ratchet with Quick Release Button :

Sockets and accessories are safely locked. By pushing the button the sockets or extension bars are released from the ratchet.

Llave de Carraca Reversible con Botón de Extracción Rápida :

Los vasos y accesorios se bloquean en posición. Los vasos o las alargaderas se extraen de la llave apretando el botón.

Reversible Ratchet with quick release button has less strength compared with normal ratchet due to the technical design. Make sure to use the ratchet correctly.

3/8" Hand Sockets



* Renewal Kits → 3753RK → P286

3774NL Flex-Head Ratchet with Head Lock Button
Llave de Carraca Flexible con Botón de Bloqueo de la Cabeza ⚠



* Renewal Kits → 3753RK → P286

3774PL Flex-Head Ratchet with Head Lock Button
Llave de Carraca Flexible con Botón de Bloqueo de la Cabeza ⚠



* Renewal Kits → 3753RK → P286

3774JL Flex-Head Ratchet with Head Lock Button
Llave de Carraca Flexible con Botón de Bloqueo de la Cabeza ⚠



* Renewal Kits → 3753RK → P286

3774JBL ⚠ Flex-Head Ratchet with Head Lock Button and Quick Release Button
Llave de Carraca Flexible con Botón de Bloqueo de la Cabeza y Botón de Extracción Rápida



	D (mm)	T (mm)	H (mm)	L (mm)	⚖ (g)	📦 (pcs.)
3774NL	30.5	26.4	15.7	265	378	2
3774PL	30.5	26.4	15.7	265	378	2
3774JL	30.5	26.4	15.7	285	367	1
3774JBL	30.5	26.4	15.7	285	367	1

⚠ Reversible Ratchet with quick release button has less strength compared with normal ratchet due to the technical design. Make sure to use the ratchet correctly.

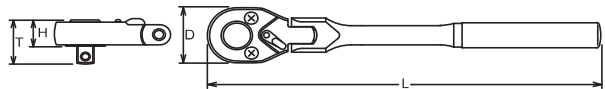

HAND MANUALES
Z-SERIES
TITANIUM DE TITANIO
ACCESSORIES ACCESORIOS
SCREWDRIVERS DESTORNILLADORES
IMPACT DE IMPACTO
SLEEVE-DRIVE
INDUSTRIAL INDUSTRIALES
PROTECTOR PROTECTORES
AUTOMOTIVE
CONSTRUCTION CONSTRUCCIÓN
RENEWAL KITS JUEGOS DE PIEZAS REPUESTO

Hand Sockets 3/8"

HAND
MANUALES

Z-SERIES

TITANIUM
DE TITANIO

ACCESSORIES
ACCESORIOS

SCREWDRIVERS
DESTORNILLADORES

IMPACT
DE IMPACTO

SLEEVE-DRIVE

INDUSTRIAL
INDUSTRIALES

PROTECTOR
PROTECTORES

AUTOMOTIVE

CONSTRUCTION
CONSTRUCCIÓN

RENEWAL KITS
JUEGOS DE PIEZAS REPUESTO

3755 Ratchet Adaptor
Adaptador de carraca



45

* Renewal Kits → 3755RK → P288

	D (mm)	L (mm)	(g)	(pcs.)
3755	30.5	55	146	5

3756 Quick Spinner
Disco de Giro Rápido

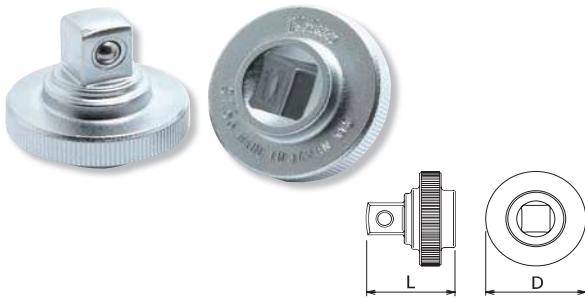

	D (mm)	L (mm)	(g)	(pcs.)
3756	30.5	25.5	47	10

3757 Ratchet Wheel
Rueda de carraca



L/B Marking 45

* Renewal Kits → 3752RK → P286

	D (mm)	L (mm)	(g)	(pcs.)
3757	50	35	155	5

3762 Flexible Extension Bar
Alargadera Flexible

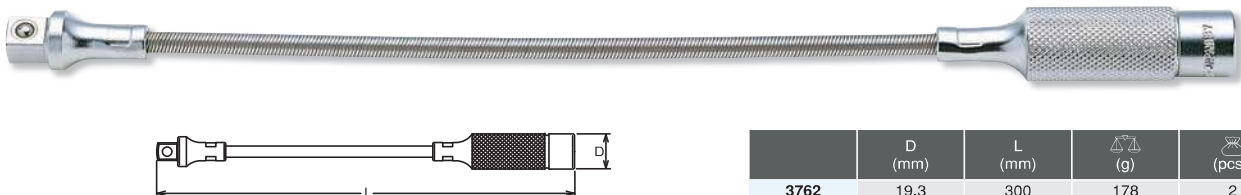

	D (mm)	L (mm)	(g)	(pcs.)
3762	19.3	300	178	2

3/8" Hand Sockets

HAND MANUALES Z-SERIES TITANIUM DE TITANIO ACCESSORIES ACCESORIOS SCREWDRIVERS DESTORNILLADORES IMPACT DE IMPACTO SLEEVE-DRIVE INDUSTRIAL INDUSTRIALES PROTECTOR PROTECTORES AUTOMOTIVE CONSTRUCTION CONSTRUCCIÓN RENEWAL KITS JUEGOS DE PIEZAS REPUESTO

3760	D (mm)	L (mm)	(g)	(pcs.)
32	18	32	27	10
50	18	50	47	10
75	18	75	68	10
125	18	125	106	10
150	18	150	125	10
250	18	250	196	5
300	18	300	291	2
400	18	400	365	1
500	18	500	490	1
600	18	600	538	1
900	18	900	805	1
1000	18	1000	968	1

3760-32 · -50 · -75 · -125 · -150 · -250 · -300 · -400 · -500 · -600 · -900 · -1000

Extension Bars
Alargaderas

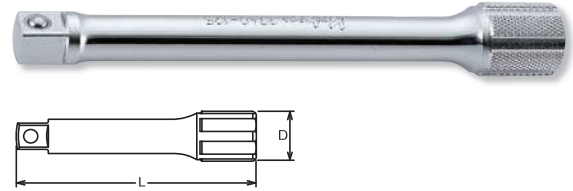

PK3760/6	6 Pieces Set/Δ=670g
PLASTIC TRAY	
Extension Bars	
3760 Extension Bars 32, 50, 75, 125, 150, 250	

PK3760/6 Set Juego



3763	D (mm)	L (mm)	(g)	(pcs.)
32	18	32	26	10
50	18	50	42	10
75	18	75	57	10
125	18	125	80	10
150	18	150	98	10
250	18	250	144	5
300	18	300	170	2



3763-32 · -50 · -75 · -125 · -150 · -250 · -300

Wobble-Fix Extension Bars
Alargaderas Articuladas-Fijas ⚠

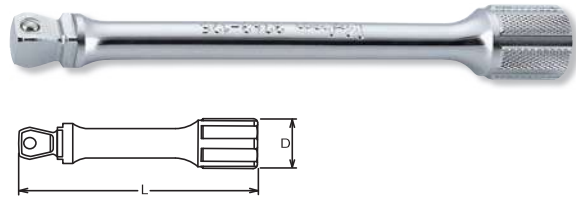

PK3763/6	6 Pieces Set/Δ=560g
PLASTIC TRAY	
Extension Bars	
3763 Wobble-Fix Extension Bars 32, 50, 75, 125, 150, 250	

PK3763/6 Set Juego



Wobble-Fix Extension Bar
Two way usage : one for as a flexible extension bar to provide at 15° angle operation, the other for use as a normal extension bar. This usage is Patent.

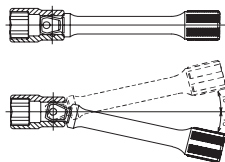

Alargadera Articulada-Fija
Dos formas de utilización : Una como alargadera flexible para poder trabajar con un ángulo de 15° y otra para utilizarse como alargadera normal. Esta aplicación está patentada.

⚠ The Wobble-Fix Extension Bar has less strength than normal extension bar due to it's specific design with a reduced square drive. Make sure to use it correctly.

Hand Sockets 3/8"

HAND
MANUALES

Z-SERIES

TITANIUM
DE TITANIO

ACCESSORIES
ACCESORIOS

SCREWDRIVERS
DESTORNILLADORES

IMPACT
DE IMPACTO

SLEEVE-DRIVE

INDUSTRIAL
INDUSTRIALES

PROTECTOR
PROTECTORES

AUTOMOTIVE

CONSTRUCTION
CONSTRUCCIÓN

RENEWAL KITS
JUEGOS DE PIEZAS REPUESTO

3768N-175 Hinge Handle
Mango Articulado



* Renewal Kits → 3768RK → P288



3768N-250 Hinge Handle
Mango Articulado



* Renewal Kits → 3768RK → P288



3768P-250 Hinge Handle
Mango Articulado



* Renewal Kits → 3768RK → P288



3768J-250 Hinge Handle
Mango Articulado



* Renewal Kits → 3768RK → P288

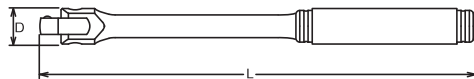

	D (mm)	L (mm)	(g)	(pcs.)
3768N-175	20.5	175	255	5
3768N-250	20.5	250	290	5
3768P-250	20.5	250	275	5
3768J-250	20.5	250	248	2

3768N-300 Hinge Handle
Mango Articulado



* Renewal Kits → 3768RK → P288



3768P-380 Hinge Handle
Mango Articulado

* Renewal Kits → 3768RK → P288

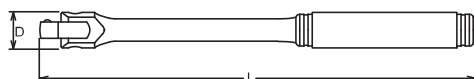

	D (mm)	L (mm)	(g)	(pcs.)
3768N-300	20.5	300	320	2
3768P-380	20.5	380	435	2

3768-300, -380 have longer handle than standard, and can be loaded to excessive torque value. In the interest of your own safety always apply load evenly and progressively to avoid breakage and possible injury.

3/8" Hand Sockets

3769N	ℓ (mm)	L (mm)	(g)	(pcs.)
160	50	160	96	2
230	120	230	126	2

⚠ Plastic or rubber handles are not intended to act as insulation.
Los mangos de plástico o de goma no están previstos para aislamiento.



3769N-160 · -230 Spin Type Handle
Mango Tipo Destornillador **⚠**



3769NWF	ℓ (mm)	L (mm)	(g)	(pcs.)
160	50	160	96	2
230	120	230	126	2

⚠ Plastic or rubber handles are not intended to act as insulation.
Los mangos de plástico o de goma no están previstos para aislamiento.



3769NWF-160 · -230 Spin Type Handle Wobble-Fix
Mango Tipo Destornillador Articulado-Fijos **⚠**

Wobble-Fix Extension Bar
Two way usage : one for as a flexible extension bar to provide at 15° angle operation, the other for use as a normal extension bar. This usage is Patent.

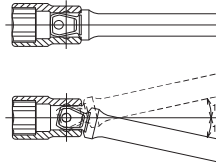

Alargadera Articulada-Fija
Dos formas de utilización : Una como alargadera flexible para poder trabajar con un ángulo de 15° y otra para utilizarse como alargadera normal. Esta aplicación está patentada.

3769H	L (mm)	(g)	(pcs.)
3769H	170	210	2

3769H Folding Socket Driver
Llave de Vaso Plegable

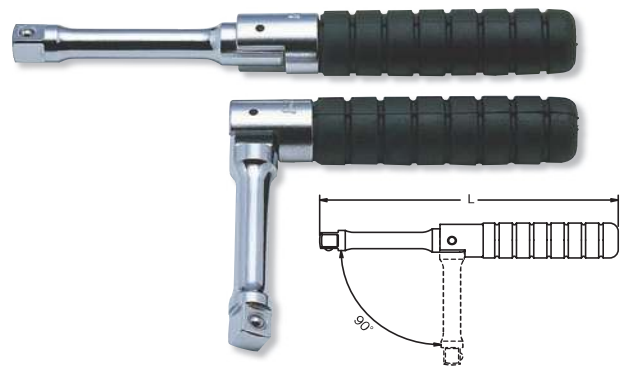

3770 Universal Joint
Articulación Universal



3771 Universal Joint
Articulación Universal



	L (mm)	(g)	(pcs.)
3770	50	66	10
3771	43	46	10

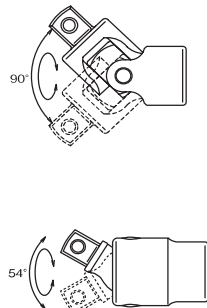

HAND
MANUALES
Z-SERIES
TITANIUM
DE TITANIO
ACCESSORIES
ACCESORIOS
SCREWDRIVERS
DESTORNILLADORES
IMPACT
DE IMPACTO
SLEEVE-DRIVE
INDUSTRIAL
INDUSTRIALES
PROTECTOR
PROTECTORES
AUTOMOTIVE
CONSTRUCTION
CONSTRUCCIÓN
RENEWAL KITS
JUEGOS DE PIEZAS REPUESTO

Hand Sockets 3/8"

3780 Speed Handle
Manivela Rápida

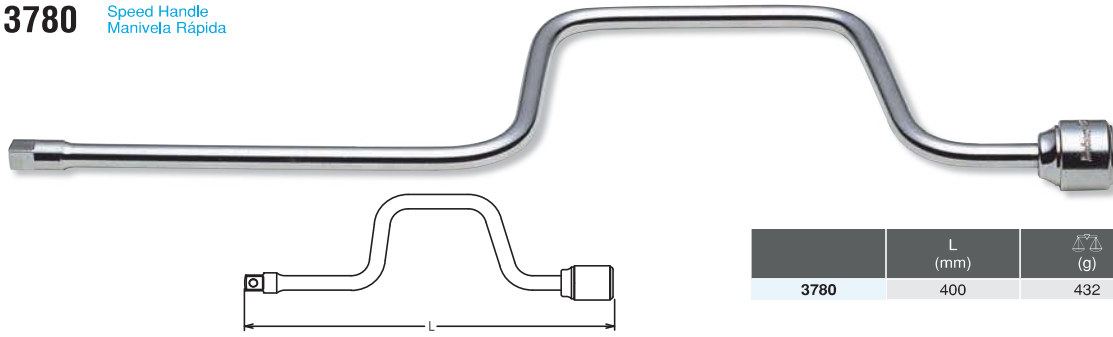

	L (mm)	(g)	(pcs.)
3780	400	432	1

3785 T-Handle
Mango Corredizo



Innovative Oval shaped bar provides higher durability and stops the sliding square part turning around the bar.



	L (mm)	(g)	(pcs.)
3785	200	157	5

3322A Adaptor
Adaptador Warranty 86Nm
Garantía 86Nm ⚠



3344A Adaptor
Adaptador

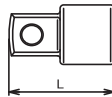

	(sq)	(sq)	L (mm)	(g)	(pcs.)
3322A	3/8"	1/4"	24	18	10
3344A	3/8"	1/2"	30	35	10

⚠ Adapting down from bigger square drive to smaller square drive may lead to excessive torque and possibly cause breakage.

La adaptación de mayor a menor de un cuadrado conductor puede conducir a un par excesivo que puede causar roturas.

PK2346/6 Set
Juego



2233A	(1/4") X 3/8"		
3322A	(3/8") X 1/4"	Warranty/Garantía	86Nm
3344A	(3/8") X 1/2"		
4433A	(1/2") X 3/8"	Warranty/Garantía	290Nm
4466A	(1/2") X 3/4"		
6644A	(3/4") X 1/2"	Warranty/Garantía	668Nm

PK2346/6		6 Pieces Set/△=460g	
PLASTIC TRAY			
Adaptors			
1/4"□→3/8"凸	2233A	3/8"□→1/4"凸	3322A
3/8"□→1/2"凸	3344A	1/2"□→3/8"凸	4433A-35
1/2"□→3/4"凸	4466A	3/4"□→1/2"凸	6644A

3200M		18 Pieces Set/△▽=2,250g	
METAL CASE:W415xH120xT50mm			
Sockets	Accessories		
<ul style="list-style-type: none"> 3400M 6-pt. Sockets 6, 8, 9, 10, 11, 12 3405M 12-pt. Sockets 13, 14, 17, 18, 19, 21 		3753N	
		3760-125	
		3760-250	
		3768N-250	
		3769N-160	
		3785	

3200A		18 Pieces Set/△▽=2,250g	
METAL CASE:W415xH120xT50mm			
Sockets	Accessories		
<ul style="list-style-type: none"> 3400A 6-pt. Sockets 1/4, 5/16, 3/8, 7/16 3405A 12-pt. Sockets 1/2, 9/16, 19/32, 5/8, 11/16, 3/4, 13/16, 7/8 		3753N	
		3760-125	
		3760-250	
		3768N-250	
		3769N-160	
		3785	

3201AMW		42 Pieces Set/△▽=4,700g	
METAL CASE:W445xH190xT50mm			
Sockets	Accessories		
<ul style="list-style-type: none"> 3405M 12-pt. Sockets 9, 10, 11, 12, 13, 14, 15, 16, 17, 18, 19, 20, 21, 22 3405A 12-pt. Sockets 5/16, 3/8, 7/16, 1/2, 9/16, 5/8, 11/16, 3/4, 25/32, 13/16, 7/8 3405W 12-pt. Sockets 1/8, 3/16, 1/4, 5/16, 3/8, 7/16, 1/2 		3753N	
		3760-75	
		3760-125	
		3760-250	
		3768N-250	
		3769N-160	
		3770	
		3780	
		3785	
		3344A	

3206M		21 Pieces Set/△▽=2,100g	
METAL CASE:W395xH90xT50mm			
Sockets	Accessories		
<ul style="list-style-type: none"> 3400M 6-pt. Sockets 6, 7, 8, 9, 10, 11, 12 3405M 12-pt. Sockets 13, 14, 15, 16, 17, 18, 19, 21, 22 		3753N	
		3760-125	
		3760-250	
		3768N-250	
		3785	

3206A		17 Pieces Set/△▽=2,000g	
METAL CASE:W395xH90xT50mm			
Sockets	Accessories		
<ul style="list-style-type: none"> 3400A 6-pt. Sockets 1/4, 5/16, 11/32, 3/8, 7/16 3405A 12-pt. Sockets 1/2, 9/16, 5/8, 11/16, 3/4, 13/16, 7/8 		3753N	
		3760-125	
		3760-250	
		3768N-250	
		3785	

3206AM		27 Pieces Set/△▽=3,500g	
METAL CASE:W445xH190xT50mm			
Sockets	Accessories		
<ul style="list-style-type: none"> 3405M 12-pt. Sockets 7, 8, 10, 11, 12, 13, 14, 15, 16, 17, 19, 22 3405A 12-pt. Sockets 3/8, 7/16, 1/2, 9/16, 5/8, 11/16, 3/4, 13/16, 7/8 3300C Spark Plug Socket 20.8 		3753N	
		3760-125	
		3760-250	
		3768N-250	
		3770	

3200M • 3200A

Socket Sets
Juegos de Vasos



3201AMW

Socket Set
Juego de Vasos



3206M

Socket Set
Juego de Vasos



3206A

Socket Set
Juego de Vasos



3206AM

Socket Set
Juego de Vasos



Hand Sockets **3/8"**

HAND
MANUALES

Z-SERIES

TITANIUM
DE TITANIO

ACCESSORIES
ACCESORIOS

SCREWDRIVERS
DESTORNILLADORES

IMPACT
DE IMPACTO

SLEEVE-DRIVE

INDUSTRIAL
INDUSTRIALES

PROTECTOR
PROTECTORES

AUTOMOTIVE

RENEWAL KITS
JUEGOS DE PIEZAS REFUESTO
CONSTRUCCIÓN
CONSTRUCCIÓN

3210M Socket Set Juego de Vasos



3210M 22 Pieces Set/Δ=2,900g

METAL CASE:W360xH145xT50mm

Sockets	Accessories
3400M 6-pt. Sockets 6, 7, 8, 9, 10, 11, 12	3753N
3405M 12-pt. Sockets 13, 14, 15, 16, 17, 18, 19, 21, 22	3760-125
	3760-250
	3768N-250
	3770
	3785

3215M · 3215A Socket Sets Juegos de Vasos



3215M 7 Pieces Set/Δ=430g

PLASTIC BAG

Sockets
3305M 12-pt. Deep Sockets 8, 10, 11, 12, 13, 14, 17

3215A 7 Pieces Set/Δ=430g

PLASTIC BAG

Sockets
3305A 12-pt. Deep Sockets 5/16, 3/8, 7/16, 1/2, 9/16, 5/8, 11/16

3217M Socket Set Juego de Vasos



3217M 14 Pieces Set/Δ=850g

METAL CASE:W163xH52xT33mm

Sockets
3405M 12-pt. Sockets 9, 10, 11, 12, 13, 14, 15, 16, 17, 18, 19, 20, 21, 22

3220M Socket Set Juego de Vasos



3220M 14 Pieces Set/Δ=2,270g

METAL CASE:W415xH120xT50mm

Sockets	Accessories
3405M 12-pt. Sockets 8, 9, 10, 11, 12, 13, 14, 17, 19, 21, 22	3753N
	3760-125
	3768N-250

3221M Socket Set Juego de Vasos



3221M 18 Pieces Set/Δ=2,300g

METAL CASE:W415xH120xT50mm

Sockets	Accessories
3405M 12-pt. Sockets 6, 8, 9, 10, 11, 12, 13, 14, 17, 19, 21, 22	3753N
	3760-125
	3760-250
	3768N-250
	3769N-160
	3785

3244 Socket Set Juego de Vasos



3244 12 Pieces Set/Δ=1,110g

METAL CASE:W240xH100xT32mm

Sockets	Accessories
3025.50 TORX® Bit Sockets T20, T25, T27, T30, T40, T45, T50	3753N
3425 TORX® Sockets E8, E10, E12	3760-75

3/8" Hand Sockets

S3240M-00	3400M 67 Pieces Set/△=2,800g	
S3240M-05	3405M 67 Pieces Set/△=2,800g	
DISPLAY STAND:W410xH160xT500mm		
Sockets		
6mm:4pcs	12mm:4pcs	18mm:4pcs
7mm:4pcs	13mm:4pcs	19mm:3pcs
8mm:4pcs	14mm:4pcs	20mm:3pcs
9mm:4pcs	15mm:4pcs	21mm:3pcs
10mm:4pcs	16mm:4pcs	22mm:3pcs
11mm:4pcs	17mm:4pcs	23mm:3pcs

3240M-00  Display Stands
3240M-05  Expositores



S3240M-00	3400M 177 Pieces Set/△=10,300g	
S3240M-05	3405M 177 Pieces Set/△=10,300g	
DISPLAY STAND:W510xH150xT230mm		
Sockets		
6mm:12pcs	12mm:12pcs	18mm:8pcs
7mm:12pcs	13mm:11pcs	19mm:8pcs
8mm:12pcs	14mm:11pcs	20mm:7pcs
9mm:12pcs	15mm:10pcs	21mm:7pcs
10mm:12pcs	16mm: 9pcs	22mm:7pcs
11mm:12pcs	17mm: 9pcs	23mm:6pcs





S3240M-00 · S3240A-00  Display Stands
S3240M-05 · S3240A-05  Expositores



S3240A-00	3400A 126 Pieces Set/△=8,500g	
S3240A-05	3405A 126 Pieces Set/△=8,500g	
DISPLAY STAND:W510xH150xT230mm		
Sockets		
1/4" :12pcs	9/16":10pcs	25/32":7pcs
5/16":12pcs	19/32":10pcs	13/16":7pcs
3/8" :12pcs	5/8" : 9pcs	7/8" :7pcs
7/16":12pcs	11/16": 9pcs	
1/2" :11pcs	3/4" : 8pcs	





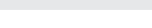

3250M  Socket Set
 Juego de Vasos



3250M	17 Pieces Set/△=2,200g	
METAL CASE:W415xH120xT50mm		
Sockets	Accessories	
 3400M 6-pt. Sockets 7, 8, 10, 11, 12, 13, 14, 15, 16, 17, 18, 19		3753N
		3760-125
		3760-250
		3770
		3785





3252M  Socket Set
 Juego de Vasos

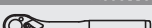

3252M	15 Pieces Set/△=1,530g	
METAL CASE:W310xH90xT48mm		
Sockets	Accessories	
 3400M 6-pt. Sockets 5.5, 7, 8, 10, 11, 12		3753P
 3405M 12-pt. Sockets 13, 14, 17, 19, 22		3760-75
		3760-125
		3770

P3262M-6P  Socket Set
 Juego de Vasos



P3262M-6P	11 Pieces Set/△=1,140g	
PLASTIC CASE:W245xH120xT45mm		
Sockets	Accessories	
 3400M 6-pt. Sockets 8, 10, 12, 13, 14, 17, 19		3753N
		3760-75
		3760-125
		3770

HAND
 MANUALES
 Z-SERIES
 TITANIUM
 DE TITANIO
 ACCESSORIES
 ACCESORIOS
 SCREWDRIVERS
 DESTORNILLADORES
 IMPACT
 DE IMPACTO
 SLEEVE-DRIVE
 INDUSTRIAL
 INDUSTRIALES
 PROTECTOR
 PROTECTORES
 AUTOMOTIVE
 CONSTRUCCION
 CONSTRUCCION
 RENEWAL KITS
 JUEGOS DE REPARACION

Hand Sockets **3/8"**

HAND
MANUALES

Z-SERIES

TITANIUM
DE TITANIO

ACCESSORIES
ACCESORIOS

SCREWDRIVERS
DESTORNILLADORES

IMPACT
DE IMPACTO

SLEEVE-DRIVE

INDUSTRIAL
INDUSTRIALES

PROTECTOR
PROTECTORES

AUTOMOTIVE

CONSTRUCTION
CONSTRUCCIÓN

RENEWAL KITS
JUEGOS DE PIEZAS REEMPLAZO

3275 Socket Set
Juego de Vasos



3275 24 Pieces Set/ΔΔ=3,150g

METAL CASE:W400xH147xT50mm

Sockets	Accessories
3400M 6-pt. Sockets 6, 7, 8, 9, 10, 11, 12	3753N
3405M 12-pt. Sockets 13, 14, 15, 16, 17, 18, 19, 21, 22	3760-125
3300C Spark Plug Sockets 16, 20.8	3760-250
	3768N-250
	3770
	3756

3276 Bit Socket Set
Juego de Vasos con Punta



3276 20 Pieces Set/ΔΔ=3,370g

METAL CASE:W310xH150xT50mm

Sockets	Accessories
3000 Bit Sockets 2, 3	3753N
3005 Bit Sockets 5, 8	3763-125
3010M.62 Hex Bit Sockets 5, 6, 7, 8, 10	
3025.50 TORX® Bit Sockets T10, T15, T20, T25, T27, T30, T40, T45, T50	

3277 Socket Set
Juego de Vasos



3277 29 Pieces Set/ΔΔ=3,240g

METAL CASE:W370xH150xT50mm

Sockets	Accessories
3400M 6-pt. Sockets 8, 9, 10, 11, 12	3753N
3405M 12-pt. Sockets 13, 14, 15, 16, 17, 18, 19, 21	3760-125
3300M 6-pt. Deep Sockets 8, 9, 10, 11, 12	3768N-250
3305M 12-pt. Deep Sockets 13, 14, 15, 16, 17, 18, 19, 21	

3279AM Socket Set
Juego de Vasos



3279AM 35 Pieces Set/ΔΔ=4,200g

METAL CASE:W445xH190xT50mm

Sockets	Accessories
3405M 12-pt. Sockets 9, 10, 11, 12, 13, 14, 15, 16, 17, 18, 19, 20, 21, 22	3753N
3405A 12-pt. Sockets 5/16, 3/8, 7/16, 1/2, 9/16, 5/8, 11/16, 3/4, 25/32, 13/16, 7/8	3760-75
3300S Spark Plug Sockets 16, 20.8	3760-125
	3760-250
	3768N-250
	3769N-160
	3770
	3785