

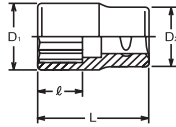



## 4400M • 4400A 6-point Sockets Vasos Hexagonales



## 4405M • 4405A 12-point Sockets Vasos Bihexagonales





4400M 4405M (mm)	D <sub>1</sub> (mm)	D <sub>2</sub> (mm)	ℓ (mm)	L (mm)	 (g)	 (pcs.)
6	10.3	21	6	36	42	10
7	11.5	21	7	36	43	10
8	13.2	21	8	36	44	10
9	13.8	21	8.5	37	44	10
10	15.3	21	9	37	45	10
11	16.5	21	9.5	37	46	10
12	17.8	21	10	37	47	10
13	19	22	10.5	37	53	10
14	20.3	22	11	37	56	10
15	21.5	22	11.5	37	57	10
16	22.8	22	12	37	62	10
17	24	23	12.5	37	69	10
18	25	24	13	37	74	10
19	26.5	25	14	38	89	10
20	27.8	26	15	38	92	10
21	29	27	15.5	38	102	10
22	30	28	16	40	113	10
23	31.5	29	16.5	40	128	10
24	32.8	30	17	42	140	5
25	34	31	18	42	164	5
26	35	32	19	42	165	5
27	36.5	33	19.5	43	182	5
28	37.8	34	20	43	198	5
29	39	35	20.5	43	205	5
30	40	36	22	46	222	5
31	41.5	37	22.5	46	246	5
32	42.8	38	23	46	261	5
33	44.2	39	24	47	275	5
34	45.2	40	24	47	315	5
35	46.2	40	24	47	317	5
36	47.2	41	24	47	336	5
37	48.3	42	24	47	360	5
38	49.2	43	24	47	380	5
41	53.1	45	29	57	471	5
46	59.1	48	32	60	567	2



4400A 4405A (inch)	D <sub>1</sub> (mm)	D <sub>2</sub> (mm)	ℓ (mm)	L (mm)	 (g)	 (pcs.)
5/16	13.2	21	8	36	44	10
3/8	14.6	21	9	37	45	10
7/16	16.5	21	9.5	37	46	10
1/2	19	22	10.5	37	53	10
9/16	20.3	22	11	37	56	10
19/32	21.5	22	11.5	37	57	10
5/8	22.8	22	12	37	62	10
21/32	24	23	12.5	37	69	10
11/16	25	24	13	37	74	10
3/4	26.5	25	14	38	89	10
25/32	27.8	26	15	38	92	10
13/16	29	27	15.5	38	102	10
7/8	30	28	16	40	113	10
15/16	32.8	30	17	42	140	5
1	35	32	19	42	165	5
1, 1/16	36.5	33	19.5	43	180	5
1, 1/8	39	35	20.5	43	210	5
1, 3/16	40	36	22	46	222	5
1, 1/4	42.8	38	23	46	261	5
1, 5/16	44.2	39	24	47	275	5
1, 3/8	46.2	40	24	47	317	5
1, 7/16	47.2	41	24	47	336	5
1, 1/2	49.2	43	24	47	380	5



RS4400M/10	10 Pieces Set/Rail 300mm	 (g)
10, 11, 12, 13, 14, 15, 17, 19, 21, 22		717



RS4405M/10	10 Pieces Set/Rail 300mm	 (g)
10, 11, 12, 13, 14, 15, 17, 19, 21, 22		717



RS4400A/10	10 Pieces Set/Rail 300mm	 (g)
3/8, 7/16, 1/2, 9/16, 5/8, 11/16, 3/4, 13/16, 7/8, 15/16		809

RS4405A/10	10 Pieces Set/Rail 300mm	 (g)
3/8, 7/16, 1/2, 9/16, 5/8, 11/16, 3/4, 13/16, 7/8, 15/16		809

**RS4400M/10**   Socket Set on Rail  
Juego de Vasos en Regleta

**RS4405M/10**  

**RS4400A/10**   Socket Set on Rail  
Juego de Vasos en Regleta

**RS4405A/10**  



# Hand Sockets 1/2"

HAND  
MANUALES

Z-SERIES

TITANIUM  
DE TITANIO

SCREWDRIVERS  
DESTORNILLADORES

IMPACT  
DE IMPACTO

SLEEVE-DRIVE

INDUSTRIAL  
INDUSTRIALES

PROTECTOR  
PROTECTORES

AUTOMOTIVE

CONSTRUCTION  
CONSTRUCCIÓN

RENEWAL KITS  
JUEGOS DE PIEZAS REFUESTO

## 4410M Surface Drive Sockets Vasos Surface Drive (de Contacto Curvo)

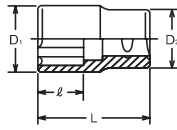

4410M (mm)	D <sub>1</sub> (mm)	D <sub>2</sub> (mm)	ℓ (mm)	L (mm)	(g)	(pcs.)
8	13.2	21	8	36	44	10
9	13.8	21	8.5	37	44	10
10	15.3	21	9	37	45	10
11	16.5	21	9.5	37	46	10
12	17.8	21	10	37	47	10
13	19	22	10.5	37	53	10
14	20.3	22	11	37	56	10
15	21.5	22	11.5	37	52	10
16	22.8	22	12	37	62	10
17	24	23	12.5	37	69	10
18	25	24	13	37	74	10
19	26.5	25	14	38	89	10
20	27.8	26	15	38	92	10
21	29	27	15.5	38	102	10
22	30	28	16	40	113	10
23	31.5	29	16.5	40	128	10
24	32.8	30	17	42	140	5
25	34	31	18	42	164	5
26	35	32	19	42	165	5
27	36.5	33	19.5	43	196	5
28	37.8	34	20	43	198	5
29	39	35	20.5	43	190	5
30	40	36	22	46	222	5
31	41.5	37	22.5	46	257	5
32	42.8	38	23	46	250	5
34	45.2	40	24	47	314	5

## RS4410M/10 Socket Set on Rail Juego de Vasos en Regleta



RS4410M/10	10 Pieces Set/Rail 300mm	(g)
10, 11, 12, 13, 14, 15, 17, 19, 21, 22		717

## 4400W 6-point Whitworth Sockets Vasos Whitworth Hexagonales

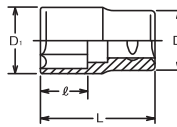

4400W (W)	D <sub>1</sub> (mm)	D <sub>2</sub> (mm)	ℓ (mm)	L (mm)	(g)	(pcs.)
3/16	16.5	21	9.5	37	46	10
1/4	19	22	10.5	37	54	10
5/16	21.5	22	11.5	37	54	10
3/8	25	24	13	37	73	10
7/16	29	27	15.5	38	87	10
1/2	31.5	29	16.5	40	133	10
9/16	35	32	19	42	165	5
5/8	37.8	34	20	43	191	5
11/16	40	36	22	46	222	5
3/4	44.2	39	24	47	280	5

## 4405W 12-point Whitworth Sockets Vasos Whitworth Bihexagonales

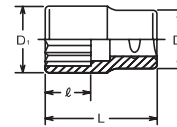

RS4400W/8	8 Pieces Set/Rail 250mm	(g)
3/16, 1/4, 5/16, 3/8, 7/16, 1/2, 9/16, 5/8		860

## RS4400W/8 Socket Set on Rail Juego de Vasos en Regleta

## RS4405W/8 Socket Set on Rail Juego de Vasos en Regleta



RS4405W/8	8 Pieces Set/Rail 250mm	(g)
3/16, 1/4, 5/16, 3/8, 7/16, 1/2, 9/16, 5/8		860

### BS W



BS W	BS W	BS											
		3/16BS	1/4BS	5/16BS	3/8BS	7/16BS	1/2BS	9/16BS	5/8BS	11/16BS	3/4BS	7/8BS	
Across Flat	(ref. mm)	8.64	11.30	13.34	15.24	18.03	20.83	23.37	25.65	27.94	30.48	33.35	

## 4425 TORX® Sockets Vasos TORX®

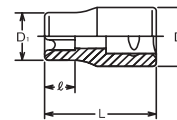

4425 (E)	D <sub>1</sub> (mm)	D <sub>2</sub> (mm)	ℓ (mm)	L (mm)	(g)	(pcs.)
E 8	10.7	21	7	36	41	10
E10	13.2	21	8.2	36	44	10
E11	13.8	21	8.7	37	45	10
E12	14.6	21	9.3	37	47	10
E14	16.5	21	10.6	37	48	10
E16	19	22	11.8	37	57	10
E18	20.3	22	13	37	57	10
E20	22.8	22	14.4	37	63	10
E22	25	24	15.5	37	78	10
E24	26.5	25	17	40	95	5

### TORX® (E)



E	S	E															
		E4	E5	E6	E7	E8	E10	E11	E12	E14	E16	E18	E20	E22	E24	E26	E28
(ref. mm)		3.83	4.72	5.69	6.17	7.47	9.37	10.03	11.12	12.85	14.71	16.64	18.41	20.24	22.10	23.85	25.65

## RS4425/7 Socket Set on Rail Juego de Vasos en Regleta



RS4425/7	7 Pieces Set/Rail 200mm	(g)
E10, E12, E14, E16, E18, E20, E24		428

4425 (E)	D <sub>1</sub> (mm)	D <sub>2</sub> (mm)	ℓ (mm)	L (mm)	(g)	(pcs.)
<b>E10N</b>	13.2	21	8.2	36	47	10
<b>E12N</b>	14.6	21	9.3	37	48	10
<b>E14N</b>	16.5	21	10.6	37	50	10
<b>E16N</b>	19	22	11.8	37	60	10
<b>E18N</b>	20.3	22	13	37	60	10
<b>E20N</b>	22.8	22	14.4	37	65	10

TORX Socket for Nut and low profile bolt  
Shallow Chamfer on Socket Opening



A : Flywheel bolt MR20 NISSAN: 4425-E20N  
B : Cam sprocket FA20 for TOYOTA/SUBARU: 4425-E16N  
C : Connecting rod bolt FA20 for TOYOTA/SUBARU: 4425-E14N

RS4425/6-N	6 Pieces Set/Rail 200mm	(g)
<b>E10N, E12N, E14N, E16N, E18N, E20N</b>		370

4425 (EPL)	D <sub>1</sub> (mm)	D <sub>2</sub> (mm)	ℓ (mm)	L (mm)	(g)	(pcs.)
<b>10EPL</b>	13.2	21	6.2	36	45	10
<b>12EPL</b>	14.6	21	7.2	37	47	10
<b>14EPL</b>	16.5	21	8.1	37	49	10
<b>16EPL</b>	19	22	9.2	37	60	10
<b>18EPL</b>	20.3	22	10.2	37	60	10
<b>20EPL</b>	22.9	22	11.2	37	65	10

RS4425/6-EPL	6 Pieces Set/Rail 200mm	(g)
<b>10EPL, 12EPL, 14EPL, 16EPL, 18EPL, 20EPL</b>		390

4450M (mm)	D <sub>1</sub> (mm)	D <sub>2</sub> (mm)	ℓ (mm)	L (mm)	(g)	(pcs.)
<b>10</b>	15.3	21	6	36	44	10
<b>11</b>	16.5	21	6.5	36	46	10
<b>12</b>	17.8	21	7	36	46	10
<b>13</b>	19	22	8	36	57	10
<b>14</b>	20.3	22	8.5	36	54	10
<b>15</b>	21.5	22	9	36	52	10
<b>16</b>	22.8	22	9	36	60	10
<b>17</b>	24	23	9.5	36	68	10
<b>18</b>	25	24	10.5	36	77	10
<b>19</b>	26.5	25	11.5	36	85	10
<b>21</b>	29	27	12	37	110	10
<b>22</b>	30	28	12.5	37	105	10
<b>24</b>	32.8	30	14.5	39	130	5
<b>27</b>	36.5	33	16.5	40	139	5

RS4450M/10	10 Pieces Set/Rail 300mm	(g)
<b>10, 11, 12, 13, 14, 15, 17, 19, 21, 22</b>		717

4400LH (LH-S)	D <sub>1</sub> (mm)	D <sub>2</sub> (mm)	ℓ (mm)	L (mm)	(g)	(pcs.)
<b>6S</b>	13.2	21	5.6	36	44	10
<b>8S</b>	16.5	21	6.8	37	46	10
<b>10S</b>	19	22	8	37	53	10
<b>12S</b>	22.8	22	9.2	37	62	10
<b>14S</b>	25	24	10.4	37	74	10
<b>16S</b>	29	27	11.6	38	102	10

RS4400LH/6	6 Pieces Set/Rail 200mm	(g)
<b>6S, 8S, 10S, 12S, 14S, 16S</b>		430

## 4425-N TORX® Sockets Vasos TORX®

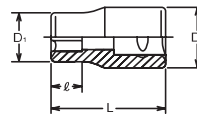

## RS4425/6-N Socket Set on Rail Juego de Vasos en Regleta



## 4425-EPL TORX PLUS® Sockets Vasos TORX PLUS®

**TORXplus**

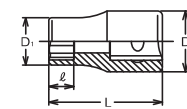

## RS4425/6-EPL Socket Set on Rail Juego de Vasos en Regleta



## 4450M Nut Grip Sockets Nut Grip® Vasos Sujeta-Tuercas Nut Grip®

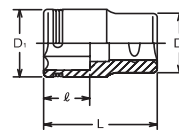

## RS4450M/10 Socket Set on Rail Juego de Vasos en Regleta



## 4400LH LHS Sockets Vasos LHS

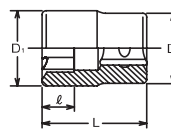

## RS4400LH/6 Socket Set on Rail Juego de Vasos en Regleta



**TORX** is a registered trademark of Acument Intellectual Properties, LLC.  
**TORX** es una marca registrada de Acument Intellectual Properties, LLC.  
**TORXplus** is a registered trademark of Acument Intellectual Properties, LLC.  
**TORXplus** es una marca registrada de Acument Intellectual Properties, LLC.  
**Nut Grip** is a registered trademark of OSG CORPORATION System Engineering Department.  
**Nut Grip** es una marca registrada de OSG CORPORATION System Engineering Department.

# Hand Sockets 1/2"

## 4300M • 4300A

6-point Deep Sockets  
Vasos Hexagonales Largos

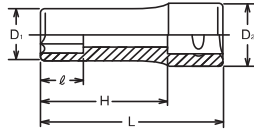

4300M 4305M (mm)	D <sub>1</sub> (mm)	D <sub>2</sub> (mm)	ℓ (mm)	H (mm)	L (mm)	⚖️ (g)	📦 (pcs.)
8	13.2	21	9	59	77	76	10
9	13.8	21	10	59	77	82	10
10	15.3	21	11	59	77	82	10
11	16.5	21	12	59	77	86	10
12	17.8	21	13	59	77	92	10
13	19	21.8	14	59	77	106	10
14	20.3	21.8	15	59	77	115	10
15	21.5	21.8	16	59	77	123	10
16	22.8	22	17	59	77	141	10
17	24	23	18	59	77	139	10
18	25	24	19	59	77	149	10
19	26.5	25	20	58	77	165	10
20	27.8	26	21	58	77	183	10
21	29	27	23	58	77	190	10
22	30	28	27	57	77	200	10
23	31.5	29	27	57	77	233	10
24	32.8	30	27	57	77	249	10
25	34	31	27	57	77	270	10
26	35	32	27	56	77	279	10
27	36.5	33	28	56	77	303	10
28	37.8	34	28	56	77	331	10
29	39	35	28	55	77	357	10
30	40	36	34	55	77	342	10
31	41.5	37	34	55	77	384	10
32	42.8	38	34	55	77	405	10
<b>New</b> 33	44.2	39	35	54	77	420	5
34	45.2	40	35	54	77	442	5
36	47.2	41	35	53	77	484	5
37	48.2	42	38	53	77	475	5
38	49	44	38	53	77	490	5

## 4305M • 4305A

12-point Deep Sockets  
Vasos Bihexagonales Largos

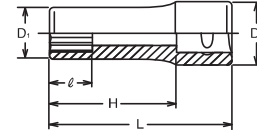

4300A 4305A (inch)	D <sub>1</sub> (mm)	D <sub>2</sub> (mm)	ℓ (mm)	H (mm)	L (mm)	⚖️ (g)	📦 (pcs.)
5/16	13.2	21	9	59	77	76	10
3/8	14.6	21	10	59	77	82	10
7/16	16.5	21	12	59	77	86	10
1/2	19	21.8	14	59	77	106	10
9/16	20.3	21.8	15	59	77	115	10
19/32	21.5	21.8	16	59	77	123	10
5/8	22.8	22	17	59	77	141	10
21/32	24	23	18	59	77	139	10
11/16	25	24	19	59	77	149	10
3/4	26.5	25	20	58	77	165	10
25/32	27.8	26	21	58	77	183	10
13/16	29	27	23	58	77	190	10
7/8	30	28	27	57	77	200	10
15/16	32.8	30	27	57	77	249	10
31/32	34	31	27	57	77	270	10
1	35	32	27	56	77	279	10
1. 1/16	36.5	33	28	56	77	303	10
1. 1/8	37.8	34	28	56	77	331	10
1. 3/16	40	36	34	55	77	342	10
1. 1/4	42.8	38	34	55	77	405	10
<b>New</b> 1. 5/16	44.2	39	35	54	77	420	5
1. 3/8	46.2	40	35	54	77	422	5
1. 7/16	47.2	41	35	53	77	484	5
1. 1/2	49	44	38	53	77	523	5
1.13/16	59	48	38	51	77	791	5

## RS4300M/10 RS4305M/10

Socket Set on Rail  
Juego de Vasos en Regleta

## RS4300A/10 RS4305A/10

Socket Set on Rail  
Juego de Vasos en Regleta



RS4300M/10	10 Pieces Set/Rail 300mm	⚖️ (g)
10, 11, 12, 13, 14, 15, 17, 19, 21, 22		1,415

RS4305M/10	10 Pieces Set/Rail 300mm	⚖️ (g)
10, 11, 12, 13, 14, 15, 17, 19, 21, 22		1,415

RS4300A/10	10 Pieces Set/Rail 300mm	⚖️ (g)
3/8, 7/16, 1/2, 9/16, 5/8, 11/16, 3/4, 13/16, 7/8, 15/16		1,600

RS4305A/10	10 Pieces Set/Rail 300mm	⚖️ (g)
3/8, 7/16, 1/2, 9/16, 5/8, 11/16, 3/4, 13/16, 7/8, 15/16		1,600

# 1/2" Hand Sockets

4300M(L120) (mm)	D <sub>1</sub> (mm)	D <sub>2</sub> (mm)	ℓ (mm)	H (mm)	L (mm)	(g)	(pcs.)
8	13.2	21	9	102	120	120	5
10	15.3	21	11	102	120	138	5
12	17.8	21	13	102	120	157	5
14	20.3	21.8	15	102	120	193	5
16	22.8	22	17	102	120	210	5

4310M (mm)	D <sub>1</sub> (mm)	D <sub>2</sub> (mm)	ℓ (mm)	H (mm)	L (mm)	(g)	(pcs.)
8	13.2	21	9	59	77	79	10
9	13.8	21	10	59	77	82	10
10	15.3	21	11	59	77	82	10
11	16.5	21	12	59	77	86	10
12	17.8	21	13	59	77	92	10
13	19	21.8	14	59	77	106	10
14	20.3	21.8	15	59	77	115	10
15	21.5	21.8	16	59	77	123	10
16	22.8	22	17	59	77	141	10
17	24	23	18	59	77	139	10
18	25	24	19	59	77	149	10
19	26.5	25	20	58	77	165	10
20	27.8	26	21	58	77	183	10
21	29	27	23	58	77	190	10
22	30	28	27	57	77	200	10
23	31.5	29	27	57	77	233	10
24	32.8	30	27	57	77	249	10
25	34	31	27	57	77	270	10
26	35	32	27	56	77	279	10
27	36.5	33	28	56	77	303	10
28	37.8	34	28	56	77	334	10
29	39	35	28	55	77	357	10
30	40	36	34	55	77	342	10
31	41.5	37	34	55	77	384	10
32	42.8	38	34	55	77	405	10
34	45.2	40	35	54	77	442	5

RS4310M/10	10 Pieces Set/Rail 300mm	(g)
10, 11, 12, 13, 14, 15, 17, 19, 21, 22		1,415

4325 (E)	D <sub>1</sub> (mm)	D <sub>2</sub> (mm)	ℓ (mm)	H (mm)	L (mm)	(g)	(pcs.)
E 8	10.7	21	7	59	77	68	10
E10	13.2	21	8.2	59	77	99	10
E11	13.8	21	8.7	59	77	84	10
E12	14.6	21	9.3	59	77	99	10
E14	16.5	21	10.6	59	77	103	10
E16	19	21.8	11.8	59	77	107	10
E18	20.3	21.8	13	59	77	118	10
E20	22.8	22	14.4	59	77	141	10
E24	26.6	25	17	59	77	215	10

TORX®  
(E)



E	E4	E5	E6	E7	E8	E10	E11	E12	E14	E16	E18	E20	E22	E24	E26	E28
S (ref. mm)	3.83	4.72	5.69	6.17	7.47	9.37	10.03	11.12	12.85	14.71	16.64	18.41	20.24	22.10	23.85	25.65

RS4325/7	7 Pieces Set/Rail 200mm	(g)
E10, E12, E14, E16, E18, E20, E24		900

## 4300M (L120) 6-point Extra Deep Sockets Vasos Hexagonales Extra Largos

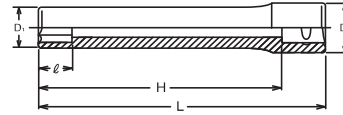

## 4310M Surface Drive Deep Sockets Vasos Surface Drive (de Contacto Curvo) Largos

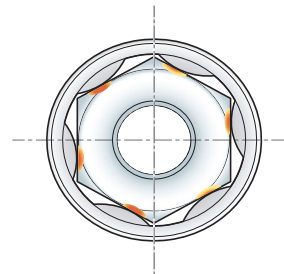
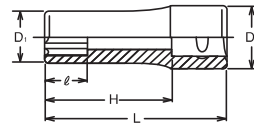

## RS4310M/10 Socket Set on Rail Juego de Vasos en Regleta



## 4325 TORX® Deep Sockets Vasos TORX® Largos

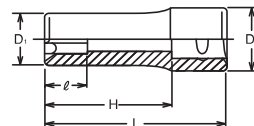



## RS4325/7 Socket Set on Rail Juego de Vasos en Regleta

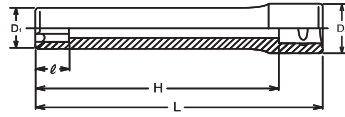

# Hand Sockets 1/2"

## 4325 (L140) TORX® Extra Deep Sockets Vasos TORX® Extra Largos



4325(L140) (E)	D <sub>1</sub> (mm)	D <sub>2</sub> (mm)	ℓ (mm)	H (mm)	L (mm)	 (g)	 (pcs.)
E 8	10.7	21	7	122	140	110	5
E10	13.2	21	8.2	122	140	140	5
E12	14.6	21	9.3	122	140	160	5
E14	16.5	21	10.6	122	140	180	5

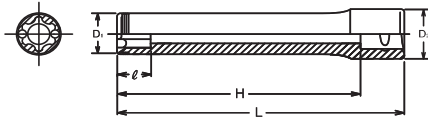

## 4325 (L140)-2B TORX® Extra Deep Sockets, Nut Grip® Vasos TORX® Extra Largos, Nut Grip®



### NUT GRIP®



Twin balls at the 6-point opening hold bolt-nut tightly for safe and reliable work.

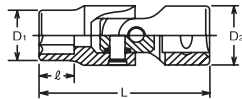

Las dos bolas de la boca Hexagonal sujetan el perno-tuerca permitiendo un trabajo seguro y fiable.

4325(L140) (E)	D <sub>1</sub> (mm)	D <sub>2</sub> (mm)	ℓ (mm)	H (mm)	L (mm)	 (g)	 (pcs.)
E 8(2B)	10.7	21	7	122	140	110	5
E10(2B)	13.2	21	8.2	122	140	140	5
E12(2B)	14.6	21	9.3	122	140	160	5
E14(2B)	16.5	21	10.6	122	140	180	5

## 4440M • 4440A 6-point Universal Sockets Vasos Hexagonales con Articulación Universal





4440M (mm)	D <sub>1</sub> (mm)	D <sub>2</sub> (mm)	ℓ (mm)	L (mm)	 (g)	 (pcs.)
9	14	25	8.3	63	150	10
10	15.3	25	8.8	63	155	10
11	16.5	25	10	65	158	10
12	17.8	25	10.5	65	151	10
13	19	25	11.4	66	152	10
14	20.3	25	11.4	66	151	10
15	21.5	25	13	68	149	10
16	22.8	25	13	68	150	10
17	24	25	14	69	150	10
18	25.3	25	14	69	150	10
19	26.5	25	15	71	170	10
20	27.8	25	15	71	173	5
21	29	25	16	72	176	5
22	30.3	25	16	72	185	5

4440A (inch)	D <sub>1</sub> (mm)	D <sub>2</sub> (mm)	ℓ (mm)	L (mm)	 (g)	 (pcs.)
3/8	14.8	25	8.8	63	155	10
7/16	16.5	25	10	65	158	10
1/2	19	25	11.4	66	152	10
9/16	20.3	25	11.4	66	151	10
5/8	22.8	25	13	68	150	10
11/16	24.6	25	14	69	153	10
3/4	26.5	25	15	71	170	10
7/8	30.3	25	16	72	185	5

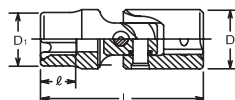
## 4440T TORX® Universal Sockets Vasos TORX® con Articulación Universal



4440T (E)	D <sub>1</sub> (mm)	D <sub>2</sub> (mm)	ℓ (mm)	L (mm)	 (g)	 (pcs.)
E10	13.2	25	8.2	62	145	10
E12	15	25	9.3	63	147	10
E14	16.3	25	10.6	65	148	10
E16	18.8	25	11.8	65	150	10
E18	20.4	25	13	67	153	10

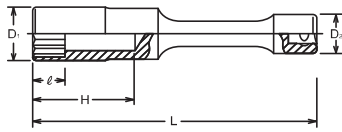

## 4117M-125 • -250

Extension Deep Sockets  
Vasos con Alargaderas



4117M.125 (mm)	D <sub>1</sub> (mm)	D <sub>2</sub> (mm)	ℓ (mm)	H (mm)	L (mm)	(g)	(pcs.)
13	18.7	24	13	59	125	213	1
14	20.2	24	14	59	125	227	1
17	24	24	17	59	125	274	1
19	26.9	24	19	59	125	279	1
21	28.5	24	21	59	125	291	1
22	30	24	22	59	125	323	1
24	32	24	24	59	125	361	1
27	36.5	24	27	59	125	439	1
30	40	24	30	59	125	461	1
32	42	24	32	59	125	498	1

4117M.250 (mm)	D <sub>1</sub> (mm)	D <sub>2</sub> (mm)	ℓ (mm)	H (mm)	L (mm)	(g)	(pcs.)
13	18.7	24	13	59	250	412	1
14	20.2	24	14	59	250	423	1
17	24	24	17	59	250	469	1
19	26.9	24	19	59	250	484	1
21	28.5	24	21	59	250	496	1
22	30	24	22	59	250	516	1
24	32	24	24	59	250	560	1
27	36.5	24	27	59	250	641	1
30	40	24	30	59	250	663	1
32	42	24	32	59	250	698	1

4000 (PH)	D (mm)	H (mm)	L (mm)	(g)	(pcs.)
2	22	23.5	60	65	10
3	22	23.5	60	65	10
4	22	23.5	60	67	10

## 4000-60 (PH)

Phillips Bit Sockets  
Vasos con Punta Phillips

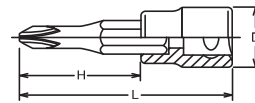

4000.60 (PZ)	D (mm)	H (mm)	L (mm)	(g)	(pcs.)
PZ2	22	23.5	60	65	10
PZ3	22	23.5	60	65	10

## 4000-60 (PZ)

PZ Bit Sockets  
Vasos con Punta PZ

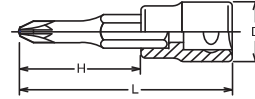

4005	T×W (mm)	D (mm)	H (mm)	L (mm)	(g)	(pcs.)
8	1.2×8	22	23.5	60	65	10
10	1.6×10	22	23.5	60	75	10
12	2.0×12	23	23.5	60	111	10
14	2.5×14	24	23.5	60	133	10
16	2.5×16	24	23.5	60	133	10

## 4005-60

Slotted Bit Sockets  
Vasos con Punta Recta para Cabezas Ranuradas

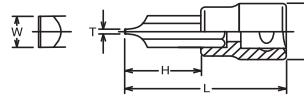

4001 (PH)	D (mm)	H (mm)	L (mm)	(g)	(pcs.)
1	21	38	60	49	10
2	21	38	60	53	10
3	21	38	60	55	10
4	21	38	60	57	10

## 4001

Phillips Bit Sockets  
Vasos con Punta Phillips

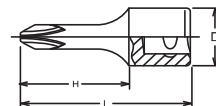

4006	T×W (mm)	D (mm)	H (mm)	L (mm)	(g)	(pcs.)
5	1.0×5.5	21	38	60	53	10
8	1.2×8	21	38	60	62	10
10	1.6×10	21	38	60	67	10
12	2.0×12	21	38	60	72	10
14	2.5×14	21	38	60	81	10
16	2.5×16	21	38	60	88	10

## 4006

Slotted Bit Sockets  
Vasos con Punta Recta para Cabezas Ranuradas

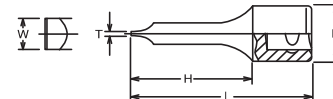

⚠ 4001, 4006 are for hand use only.  
Do not use with an impact wrench.

# Hand Sockets 1/2"

HAND  
MANUALES

Z-SERIES

TITANIUM  
DE TITANIO

ACCESSORIES  
ACCESORIOS

SCREWDRIVERS  
DESTORNILLADORES

IMPACT  
DE IMPACTO

SLEEVE-DRIVE

INDUSTRIAL  
INDUSTRIALES

PROTECTOR  
PROTECTORES

AUTOMOTIVE

CONSTRUCTION  
CONSTRUCCIÓN

RENEWAL KITS  
JUEGOS DE PIEZAS REFUESTO

## 4010M-50 • -75 • -100 • -160 4010A-60

 Inhex Bit Sockets  
Vasos con Punta Hexagonal



4010M.50 (mm)	D (mm)	H (mm)	L (mm)	⚖️ (g)	📦 (pcs.)
4	22	13.5	50	61	10
5	22	13.5	50	62	10
6	22	13.5	50	64	10
7	22	13.5	50	65	10
8	22	13.5	50	66	10
10	22	13.5	50	75	10
12	23	13.5	50	105	10
13	24	13.5	50	120	10
14	24	13.5	50	120	10
16	25	15	50	150	10
17	25	15	50	150	10
18	27	15	50	200	5
19	27	15	50	200	5

4010M.75 (mm)	D (mm)	H (mm)	L (mm)	⚖️ (g)	📦 (pcs.)
4	22	38.5	75	69	10
5	22	38.5	75	70	10
6	22	38.5	75	72	10
7	22	38.5	75	73	10
8	22	38.5	75	74	10
10	22	38.5	75	92	10
12	23	38.5	75	130	10
13	24	38.5	75	150	10
14	24	38.5	75	150	10
16	25	35	75	180	10
17	25	35	75	180	10
18	27	33	75	230	5
19	27	33	75	230	5

4010M.100 (mm)	D (mm)	H (mm)	L (mm)	⚖️ (g)	📦 (pcs.)
4	22	63.5	100	77	10
5	22	63.5	100	78	10
6	22	63.5	100	80	10
7	22	63.5	100	82	10
8	22	63.5	100	84	10
10	22	63.5	100	109	10
12	23	63.5	100	155	10
13	24	63.5	100	180	5
14	24	63.5	100	180	5
16	25	60	100	250	5
17	25	60	100	250	5
18	27	58	100	300	5
19	27	58	100	300	5

4010M.160 (mm)	D (mm)	H (mm)	L (mm)	⚖️ (g)	📦 (pcs.)
4	22	123.5	160	103	10
5	22	123.5	160	104	10
6	22	123.5	160	106	10
7	22	123.5	160	108	10
8	22	123.5	160	110	10
10	22	123.5	160	126	10
12	23	123.5	160	180	5
14	24	123.5	160	260	5
17	25	120	160	360	5
19	27	118	160	415	5

4010A.60 (inch)	D (mm)	H (mm)	L (mm)	⚖️ (g)	📦 (pcs.)
New 5/32	22	23.5	60	57	10
New 3/16	22	23.5	60	57	10
New 7/32	22	23.5	60	59	10
New 1/4	22	23.5	60	63	10
New 9/32	22	23.5	60	65	10
New 5/16	22	23.5	60	67	10
New 11/32	22	23.5	60	75	10
New 3/8	22	23.5	60	76	10
New 7/16	23	23.5	60	101	10
New 1/2	24	23.5	60	124	10
New 9/16	25	20	60	127	10
New 5/8	25	20	60	174	10
New 3/4	27	18	60	220	5



**RS4010M/10-L50**   Socket Set on Rail  
Juego de Vasos en Regleta

**RS4010M/10-L75**  

**RS4010A/10-L60**  



RS4010M/10-L50	10 Pieces Set/Rail 300mm	⚖️ (g)
4, 5, 6, 7, 8, 10, 12, 14, 17, 19		968

RS4010M/10-L75	10 Pieces Set/Rail 300mm	⚖️ (g)
4, 5, 6, 7, 8, 10, 12, 14, 17, 19		1,207

RS4010A/10-L60	10 Pieces Set/Rail 300mm	⚖️ (g)
New 3/16, 7/32, 1/4, 5/16, 3/8, 7/16, 1/2, 9/16, 5/8, 3/4		1,080



# 1/2" Hand Sockets

4020-60 · -100 · -120 · -140

 XZN Bit Sockets  
Vasos con Punta XZN

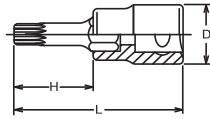

4020.60 (XZN)	D (mm)	H (mm)	L (mm)	(g)	(pcs.)
M 5	22	23.5	60	60	10
M 6	22	23.5	60	61	10
M 8	22	23.5	60	63	10
M10	23	23.5	60	93	10
M12	23	23.5	60	97	10
M14	24	23.5	60	105	10
M16	25	20	60	165	10
M18	27	20	60	215	5

4020.100 (XZN)	D (mm)	H (mm)	L (mm)	(g)	(pcs.)
M 5	22	63.5	100	77	10
M 6	22	63.5	100	78	10
M 8	22	63.5	100	80	10
M10	23	63.5	100	132	10
M12	23	63.5	100	136	10
M14	24	63.5	100	144	5
M16	25	60	100	250	5
M18	27	60	100	300	5

4020.120 (XZN)	D (mm)	H (mm)	L (mm)	(g)	(pcs.)
M 5	22	83.5	120	86	10
M 6	22	83.5	120	87	10
M 8	22	83.5	120	89	10
M10	23	83.5	120	152	10
M12	23	83.5	120	156	10
M14	24	83.5	120	164	5

4020.140 (XZN)	D (mm)	H (mm)	L (mm)	(g)	(pcs.)
M 5	22	103.5	140	95	10
M 6	22	103.5	140	96	10
M 8	22	103.5	140	98	10
M10	23	103.5	140	172	5
M12	23	103.5	140	176	5
M14	24	103.5	140	184	5

XZN













XZN		M4	M5	M6	M8	M10	M12	M14	M16	M18
S	(ref. mm)	3.60	4.80	6.00	7.20	9.60	11.41	13.22	15.63	16.85

RS4020/6-L60	6 Pieces Set/Rail 150mm	(g)
M5, M6, M8, M10, M12, M14		500

RS4020/6-L60

  Socket Set on Rail  
Juego de Vasos en Regleta



	 Phillips (PH)	 PZ	 Slotted	 HEX	 HEX (ball point)	 Triple Square (XZN)	 TORX® (T)	 TORX® (TH)	 TORXplus® (IP)	 Penta-Lobe (PR)	 Ribe-CV
1/4"	No.2000 series	No.2000(PZ) series	No.2005 series	No.2010M/A series	No.2011M series	No.2020 series	No.2025 series	No.2025(TH) series	No.2025(IP) series	No.2025(PR) series	—
3/8"	No.3000 No.3001 series	No.3000(PZ) series	No.3005 No.3006 series	No.3010M/A No.3012M/A No.3015M series	No.3011M series	No.3020 series	No.3025 series	No.3025(TH) series	No.3025(IP) series	No.3025(PR) series	No.3027 series
1/2"	No.4000 No.4001 series	No.4000(PZ) series	No.4005 No.4006 series	No.4010M/A No.4012M/A series	—	No.4020 series	No.4025 series	—	No.4025(IP) series	—	No.4027 series

# Hand Sockets 1/2"

## 4025-60 · -100 · -140 (T)

 TORX® Bit Sockets  
Vasos con Punta TORX®

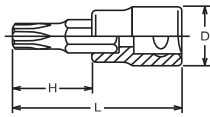

4025.60 (T)	D (mm)	H (mm)	L (mm)	(g)	(pcs.)
T20	22	23.5	60	59	10
T25	22	23.5	60	60	10
T27	22	23.5	60	60	10
T30	22	23.5	60	60	10
T40	22	23.5	60	62	10
T45	22	23.5	60	64	10
T50	22	23.5	60	74	10
T55	23	23.5	60	96	10
T60	24	23.5	60	122	10
T70	24	23.5	60	135	10
<b>New</b> T80	24	20	60	168	10

4025.100 (T)	D (mm)	H (mm)	L (mm)	(g)	(pcs.)
T20	22	73.5	100	76	10
T25	22	73.5	100	76	10
T27	22	73.5	100	77	10
T30	22	73.5	100	77	10
T40	22	73.5	100	78	10
T45	22	73.5	100	80	10
T50	22	73.5	100	98	10
T55	23	73.5	100	132	10
T60	24	73.5	100	170	5
T70	24	73.5	100	175	5

4025.140 (T)	D (mm)	H (mm)	L (mm)	(g)	(pcs.)
T20	22	103.5	140	94	10
T25	22	103.5	140	95	10
T27	22	103.5	140	95	10
T30	22	103.5	140	95	10
T40	22	103.5	140	97	10
T45	22	103.5	140	99	10
T50	22	103.5	140	129	10
T55	23	103.5	140	175	5
T60	24	103.5	140	229	5
T70	24	103.5	140	245	5
<b>New</b> T80	24	100	140	320	5

TORX®  
(T)

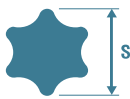

T	T8	T9	T10	T15	T20	T25	T27	T30	T40	T45	T50	T55	T60	T70	T80	T90	T100
S (ref. mm)	2.30	2.48	2.72	3.26	3.84	4.40	4.96	5.49	6.60	7.77	8.79	11.17	13.20	15.49	17.51	19.88	22.09

## RS4025/9-L60

 Socket Set on Rail  
Juego de Vasos en Regleta



RS4025/9-L60	9 Pieces Set/Rail 250mm	(g)
T20, T25, T27, T30, T40, T45, T50, T55, T60		700

## 4025-60-T35

 Bit Socket  
Vasos con Punta



4025.60 (T)	D (mm)	H (mm)	L (mm)	(g)	(pcs.)
T35	22	23.5	60	96	10

4025,60 (IP)	D (mm)	H (mm)	L (mm)	(g)	(pcs.)
20IP	22	23.5	60	60	10
25IP	22	23.5	60	60	10
27IP	22	23.5	60	60	10
30IP	22	23.5	60	60	10
40IP	22	23.5	60	60	10
45IP	22	23.5	60	64	10
50IP	22	23.5	60	74	10
55IP	23	23.5	60	96	10
60IP	24	23.5	60	122	10
70IP	24	23.5	60	170	10

4025,100 (IP)	D (mm)	H (mm)	L (mm)	(g)	(pcs.)
40IP	22	63.5	100	79	10
45IP	22	63.5	100	81	10
50IP	22	63.5	100	100	10
55IP	23	63.5	100	133	10
60IP	24	63.5	100	172	5
70IP	25	63.5	100	241	5

RS4025/9-IP	9 Pieces set/Rail 250mm	(g)
20IP, 25IP, 27IP, 30IP, 40IP, 45IP, 50IP, 55IP, 60IP		700

### TORXplus® (IP)



IP	8IP	9IP	10IP	15IP	20IP	25IP	27IP	30IP	40IP	45IP	50IP	55IP	60IP	70IP	
S	(ref. mm)	2.29	2.48	2.72	3.25	3.84	4.39	4.95	5.49	6.60	7.77	8.79	11.16	13.20	15.49

## 4025-60 · -100 (IP)

TORX PLUS® Bit Sockets  
Vasos con Punta TORX PLUS®

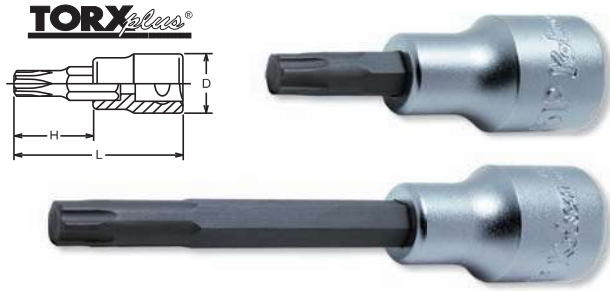

## RS4025/9-IP

Socket Set on Rail  
Juego de Vasos en Regleta



4027,60	D (mm)	H (mm)	L (mm)	(g)	(pcs.)
M 5	22	23.5	60	60	10
M 6	22	23.5	60	62	10
M 7	22	23.5	60	63	10
M 8	22	23.5	60	64	10
M 9	22	23.5	60	70	10
M10	22	23.5	60	74	10
M12	23	23.5	60	96	10
M13	24	23.5	60	116	10
M14	24	23.5	60	122	10
M16	24	25	60	135	10

4027,100	D (mm)	H (mm)	L (mm)	(g)	(pcs.)
M 5	22	63.5	100	67	10
M 6	22	63.5	100	68	10
M 7	22	63.5	100	75	10
M 8	22	63.5	100	81	10
M 9	22	63.5	100	90	10
M10	22	63.5	100	101	10
M12	23	63.5	100	134	10
M13	24	63.5	100	155	5
M14	24	63.5	100	173	5
M16	24	60	100	241	5

4027,140	D (mm)	H (mm)	L (mm)	(g)	(pcs.)
M 8	22	103.5	140	98	10
M10	22	103.5	140	127	10
M12	23	103.5	140	171	5
M14	24	103.5	140	226	5
M16	24	100	140	320	5

RS4027/6-L60	6 Pieces set/Rail 200mm	(g)
M5, M6, M8, M10, M12, M14		600

### Ribe CV

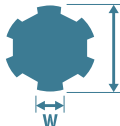

CV	M5	M6	M7	M8	M9	M10	M12	M13	M14	M16	
S	(ref. mm)	5	6	7	8	9	10	12	13	14	16
W	(ref. mm)	1.1	1.3	1.4	1.7	1.9	2.2	2.6	3.0	3.1	3.5

## 4027-60 · -100 · -140

Bit Sockets for Ribe Screws  
Vasos con Punta para Tornillos Ribe

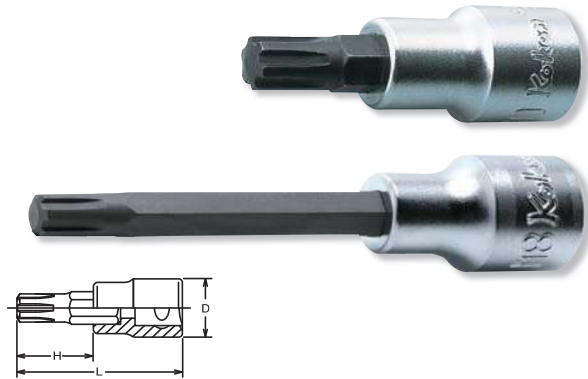

## RS4027/6-L60

Socket Set on Rail  
Juego de Vasos en Regleta



# Hand Sockets 1/2"

## 4012M-43 • -60 • -75 • -100

Inhex Sockets  
Vasos con Punta de Hexagonal ⚠

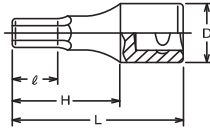

4012M.43 (mm)	D (mm)	l (mm)	H (mm)	L (mm)	(g)	(pcs.)
4	21.1	11.5	23	43	40	10
5	21.1	11.5	23	43	46	10
6	21.1	11.5	23	43	42	10
7	21.1	11.5	23	43	46	10
8	21.1	11.5	23	43	49	10
9	21.1	11.5	23	43	63	10
10	23	11.5	23	43	63	10
11	25	11.5	23	43	74	10
12	25	11.5	23	43	81	10
13	25	11.5	23	43	85	10
14	25	11.5	23	43	88	10
15	26	11.5	23	43	91	10
16	26	11.5	23	43	100	10
17	26	11.5	23	43	101	10
18	26	11.5	23	43	106	10
19	26	11.5	23	43	110	10
20	26	11.5	23	43	130	10
21	26	11.5	23	43	140	10
22	26	11.5	23	43	145	10
23	28	11.5	23	43	167	10
24	28	11.5	23	43	170	10
27	32	11.5	23	43	226	10

4012M.60 (mm)	D (mm)	l (mm)	H (mm)	L (mm)	(g)	(pcs.)
4	21.1	15.5	38	60	49	10
5	21.1	15.5	38	60	55	10
6	21.1	15.5	38	60	56	10
7	21.1	15.5	38	60	60	10
8	21.1	15.5	38	60	64	10
9	21.1	15.5	38	60	78	10
10	23	15.5	38	60	78	10
11	25	15.5	38	60	100	10
12	25	15.5	38	60	107	10
13	25	15.5	38	60	111	10
14	25	15.5	38	60	122	10
15	26	15.5	38	60	125	10
16	26	15.5	38	60	134	10
17	26	15.5	38	60	141	10
18	26	15.5	38	60	153	10
19	26	15.5	38	60	159	10
21	26	15.5	38	60	197	10
22	26	22.5	38	60	205	10
23	28	22.5	38	60	242	10
24	28	22.5	38	60	245	10

4012M.75 (mm)	D (mm)	l (mm)	H (mm)	L (mm)	(g)	(pcs.)
4	21.1	15.5	53	75	52	10
5	21.1	15.5	53	75	58	10
6	21.1	15.5	53	75	62	10
7	21.1	15.5	53	75	70	10
8	21.1	15.5	53	75	74	10
9	21.1	15.5	53	75	88	10
10	23	15.5	53	75	94	10
11	25	15.5	53	75	119	10
12	25	15.5	53	75	122	10
13	25	15.5	53	75	137	10
14	25	15.5	53	75	148	10
15	26	15.5	53	75	151	10
16	26	15.5	53	75	171	10
17	26	15.5	53	75	184	10
18	26	15.5	53	75	196	10
19	26	15.5	53	75	212	10

4012M.100 (mm)	D (mm)	l (mm)	H (mm)	L (mm)	(g)	(pcs.)
4	24	15.5	78	100	75	10
5	24	15.5	78	100	81	10
6	24	15.5	78	100	85	10
7	24	15.5	78	100	93	10
8	24	15.5	78	100	97	10
9	24	15.5	78	100	111	10
10	24	15.5	78	100	117	10
11	24	15.5	78	100	142	10
12	24	15.5	78	100	143	10
13	24	15.5	78	100	158	10
14	24	15.5	78	100	169	10
15	24	15.5	78	100	172	10
16	24	15.5	78	100	192	5
17	24	15.5	78	100	215	5
18	24	15.5	78	100	227	5
19	24	15.5	78	100	243	5

## RS4012M/10-L60

Socket Set on Rail  
Juego de Vasos en Regleta



RS4012M/10-L60	10 Pieces set/Rail 300mm	(g)
4, 5, 6, 7, 8, 10, 12, 14, 17, 19		910

⚠ 4012M/A are for hand use only.  
Do not use with an impact wrench.

## 4012A-43 · -60 · -75 · -100

Inhex Sockets  
Vasos Inhex

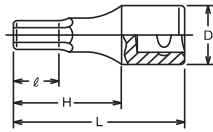

4012A.43 (inch)	D (mm)	ℓ (mm)	H (mm)	L (mm)	(g)	(pcs.)
5/32	21.1	11.5	23	43	40	10
3/16	21.1	11.5	23	43	46	10
7/32	21.1	11.5	23	43	42	10
1/4	21.1	11.5	23	43	43	10
9/32	21.1	11.5	23	43	46	10
5/16	21.1	11.5	23	43	49	10
11/32	21.1	11.5	23	43	63	10
3/8	23	11.5	23	43	59	10
7/16	25	11.5	23	43	74	10
1/2	25	11.5	23	43	85	10
9/16	25	11.5	23	43	88	10
5/8	26	11.5	23	43	100	10
3/4	26	11.5	23	43	110	10

4012A.60 (inch)	D (mm)	ℓ (mm)	H (mm)	L (mm)	(g)	(pcs.)
5/32	21.1	15.5	38	60	49	10
3/16	21.1	15.5	38	60	55	10
7/32	21.1	15.5	38	60	56	10
1/4	21.1	15.5	38	60	57	10
9/32	21.1	15.5	38	60	60	10
5/16	21.1	15.5	38	60	64	10
11/32	21.1	15.5	38	60	78	10
3/8	23	15.5	38	60	74	10
7/16	25	15.5	38	60	100	10
1/2	25	15.5	38	60	111	10
9/16	25	15.5	38	60	122	10
5/8	26	15.5	38	60	134	10
3/4	26	15.5	38	60	159	10

4012A.75 (inch)	D (mm)	ℓ (mm)	H (mm)	L (mm)	(g)	(pcs.)
5/32	21.1	15.5	53	75	52	10
3/16	21.1	15.5	53	75	58	10
7/32	21.1	15.5	53	75	62	10
1/4	21.1	15.5	53	75	65	10
9/32	21.1	15.5	53	75	70	10
5/16	21.1	15.5	53	75	74	10
11/32	21.1	15.5	53	75	88	10
3/8	23	15.5	53	75	86	10
7/16	25	15.5	53	75	119	10
1/2	25	15.5	53	75	137	10
9/16	25	15.5	53	75	148	10
5/8	26	15.5	53	75	171	10
3/4	26	15.5	53	75	212	10

4012A.100 (inch)	D (mm)	ℓ (mm)	H (mm)	L (mm)	(g)	(pcs.)
5/32	24	15.5	78	100	75	10
3/16	24	15.5	78	100	81	10
7/32	24	15.5	78	100	85	10
1/4	24	15.5	78	100	88	10
9/32	24	15.5	78	100	93	10
5/16	24	15.5	78	100	97	10
11/32	24	15.5	78	100	111	10
3/8	24	15.5	78	100	109	10
7/16	24	15.5	78	100	142	10
1/2	24	15.5	78	100	158	10
9/16	24	15.5	78	100	169	10
5/8	24	15.5	78	100	192	5
3/4	24	15.5	78	100	243	5

RS4012A/10-L60	10 Pieces set/Rail 300mm	(g)
3/16, 7/32, 1/4, 5/16, 3/8, 7/16, 1/2, 9/16, 5/8, 3/4		950

## RS4012A/10-L60



Socket Set on Rail  
Juego de Vasos en Regleta



4012M/A are for hand use only.  
Do not use with an impact wrench.

# Hand Sockets **1/2"**

HAND  
MANUALES

Z-SERIES

TITANIUM  
DE TITANIO

ACCESSORIES  
ACCESORIOS

SCREWDRIVERS  
DESTORNILLADORES

IMPACT  
DE IMPACTO

SLEEVE-DRIVE

INDUSTRIAL  
INDUSTRIALES

PROTECTOR  
PROTECTORES

AUTOMOTIVE

CONSTRUCTION  
CONSTRUCCIÓN

RENEWAL KITS  
JUEGOS DE PIEZAS REFUESTO

## 3749S-1/2 Reversible Ratchet Short Llave de Carraca Reversible Corta



\* Renewal Kits → 3749SRK-1/2 → P287

## 3749SB-1/2 Reversible Ratchet Short with Quick Release Button Llave de Carraca Reversible corta con botón de extracción rápida



\* Renewal Kits → 3749SBRK-1/2 → P287

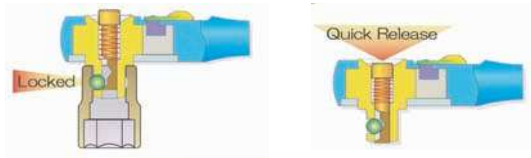
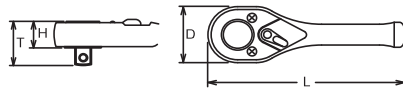

	D (mm)	T (mm)	H (mm)	L (mm)	(g)	(pcs.)
3749S-1/2	34	29	14.4	110	200	5
3749SB-1/2	34	29	14.4	110	200	5

⚠ Reversible Ratchet with quick release button has less strength compared with normal ratchet due to the technical design. Make sure to use the ratchet correctly.

## 4749N-250 Reversible Ratchet Llave de Carraca Reversible



\* Renewal Kits → 4749RK → P287

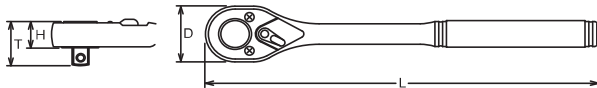

	D (mm)	T (mm)	H (mm)	L (mm)	(g)	(pcs.)
4749N-250	44.6	33	18.4	250	616	1

## 4749N-380 Reversible Ratchet Long Llave de Carraca Reversible Larga



\* Renewal Kits → 4749RK → P287

## 4749J-380 Reversible Ratchet Long Llave de Carraca Reversible Larga



\* Renewal Kits → 4749RK → P287

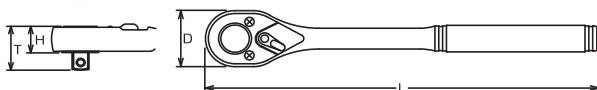

	D (mm)	T (mm)	H (mm)	L (mm)	(g)	(pcs.)
4749N-380	44.6	33	18.4	380	753	1
4749J-380	44.6	33	18.4	380	743	1



## [4750 series]

Two dogs are set in the same axis and the three teeth hold the ratchet gear.  
The enlarged contact area produces an about 10% higher torque value and the S.O.D.H system provides smooth and light movements.

Se disponen dos trinquetes en el mismo eje y la rueda de la llave de carraca se bloquea por medio de tres dientes.  
El aumento de la superficie de contacto produce un aumento del par de aproximadamente 10% y el sistema S.O.D.H permite movimientos suaves y sin esfuerzo.



\* Renewal Kits → 4750RK → P287



**4750N** Reversible Ratchet  
Llave de Carraca Reversible



\* Renewal Kits → 4750RK → P287



**4750P** Reversible Ratchet  
Llave de Carraca Reversible



\* Renewal Kits → 4750RK → P287



**4750J** Reversible Ratchet  
Llave de Carraca Reversible

	D (mm)	T (mm)	H (mm)	L (mm)	△ (g)	◇ (pce.)
4750N	38	35.9	21.3	250	548	1
4750P	38	35.9	21.3	250	553	1
4750J	38	35.9	21.3	250	508	1

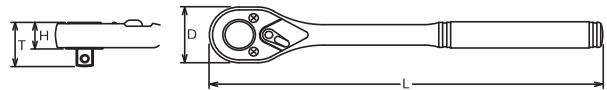

\* Renewal Kits → 4750BRK → P287



**4750NB** Reversible Ratchet with Quick Release Button  
Llave de Carraca con botón de extracción rápida ⚠



\* Renewal Kits → 4750BRK → P287



**4750PB** Reversible Ratchet with Quick Release Button  
Llave de Carraca con botón de extracción rápida ⚠



\* Renewal Kits → 4750BRK → P287



**4750JB** Reversible Ratchet with Quick Release Button  
Llave de Carraca con botón de extracción rápida ⚠

	D (mm)	T (mm)	H (mm)	L (mm)	△ (g)	◇ (pce.)
4750NB	38	35.9	21.3	250	548	1
4750PB	38	35.9	21.3	250	553	1
4750JB	38	35.9	21.3	250	508	1

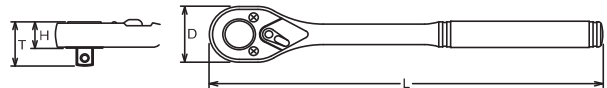

⚠ Reversible Ratchet with quick release button has less strength compared with normal ratchet due to the technical design. Make sure to use the ratchet correctly.

# Hand Sockets 1/2"

HAND  
MANUALES

Z-SERIES

TITANIUM  
DE TITANIO

ACCESSORIES  
ACCESORIOS

SCREWDRIVERS  
DESTORNILLADORES

IMPACT  
DE IMPACTO

SLEEVE-DRIVE

INDUSTRIAL  
INDUSTRIALES

PROTECTOR  
PROTECTORES

AUTOMOTIVE

CONSTRUCTION  
CONSTRUCCIÓN

RENEWAL KITS  
JUEGOS DE PIEZAS REPUESTO

**4752N** Reversible Ratchet  
Llave de Carraca Reversible



\* Renewal Kits → 4752RK → P287



**4752J** Reversible Ratchet  
Llave de Carraca Reversible



\* Renewal Kits → 4752RK → P287

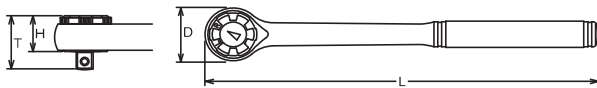

	D (mm)	T (mm)	H (mm)	L (mm)	(g)	(pce.)
4752N	35	38.8	24.5	250	480	1
4752J	35	38.8	24.5	250	470	1

## [L/R Marking]



A pointer and L/R markings on the ratchet head indicate the turning direction. The reduced diameter of the head allows easier access in tight spots.

Una flecha y unas marcas L/R en el cabezal de la llave (L = Izquierda / R = Derecha) indican el sentido de giro. El diámetro reducido del cabezal permite un acceso más fácil en lugares estrechos.

**4753N** Reversible Ratchet  
Llave de Carraca Reversible



\* Renewal Kits → 4753RK → P287

**4753P** Reversible Ratchet  
Llave de Carraca Reversible



\* Renewal Kits → 4753RK → P287

**4753J** Reversible Ratchet  
Llave de Carraca Reversible



\* Renewal Kits → 4753RK → P287

**D4753J** Reversible Ratchet  
Llave de Carraca Reversible



\* Renewal Kits → 4753RK → P287

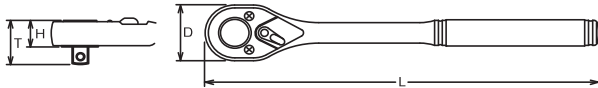

	D (mm)	T (mm)	H (mm)	L (mm)	(g)	(pce.)
4753N	38	36.2	21.6	250	595	1
4753P	38	36.2	21.6	250	570	1
4753J	38	36.2	21.6	250	545	1
D4753J	38	36.2	21.6	250	510	1

**4753P-410** Reversible Ratchet Long  
Llave de Carraca Reversible Larga



\* Renewal Kits → 4753RK → P287

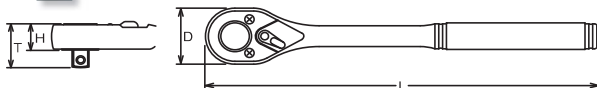

	D (mm)	T (mm)	H (mm)	L (mm)	(g)	(pce.)
4753P-410	38	36.2	21.6	410	790	1



# 1/2" Hand Sockets

HAND  
MANUALES  
Z-SERIES  
TITANIUM  
DE TITANIO  
ACCESSORIES  
ACCESORIOS  
SCREWDRIVERS  
DESTORNILLADORES  
IMPACT  
DE IMPACTO  
SLEEVE-DRIVE  
INDUSTRIAL  
INDUSTRIALES  
PROTECTOR  
PROTECTORES  
AUTOMOTIVE  
CONSTRUCTION  
CONSTRUCCIÓN  
RENEWAL KITS  
JUEGOS DE PIEZAS REPUESTO

**4753NB** Reversible Ratchet with Quick Release Button  
Llave de Carraca Reversible con botón de extracción rápida ⚠



**4753PB** Reversible Ratchet with Quick Release Button  
Llave de Carraca Reversible con botón de extracción rápida ⚠



**4753JB** Reversible Ratchet with Quick Release Button  
Llave de Carraca Reversible con botón de extracción rápida ⚠



	D (mm)	T (mm)	H (mm)	L (mm)	⚖ (g)	◇ (pce.)
4753NB	38	36.2	21.6	250	595	1
4753PB	38	36.2	21.6	250	570	1
4753JB	38	36.2	21.6	250	545	1

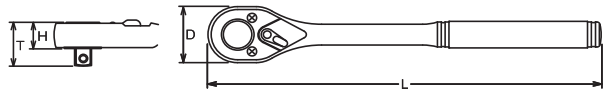

⚠ Reversible Ratchet with quick release button has less strength compared with normal ratchet due to the technical design. Make sure to use the ratchet correctly.

**Reversible Ratchet with Quick Release Button :**  
Sockets and accessories are safely locked.  
By pushing the button the sockets or extension bars are released from the ratchet.

**Llave de Carraca Reversible con Botón de Extracción Rápida :** Los vasos y accesorios se bloquean en posición. Los vasos o las alargaderas se extraen de la llave apretando el botón.



## GEAR TEETH



4749series



4753series



4750series



4752series



4774series



# Hand Sockets 1/2"

HAND  
MANUALES

Z-SERIES

TITANIUM  
DE TITANIO

ACCESSORIES  
ACCESORIOS

SCREWDRIVERS  
DESTORNILLADORES

IMPACT  
DE IMPACTO

SLEEVE-DRIVE

INDUSTRIAL  
INDUSTRIALES

PROTECTOR  
PROTECTORES

AUTOMOTIVE

CONSTRUCTION  
CONSTRUCCIÓN

RENEWAL KITS  
JUEGOS DE PIEZAS REFLEJO

**4774N** Flexible Ratchet, Reversible  
Llave de Carraca Flexible, Reversible



\* Renewal Kits → 4753RK → P287



**4774P** Flexible Ratchet, Reversible  
Llave de Carraca Flexible, Reversible



\* Renewal Kits → 4753RK → P287



**4774J** Flexible Ratchet, Reversible  
Llave de Carraca Flexible, Reversible



\* Renewal Kits → 4753RK → P287

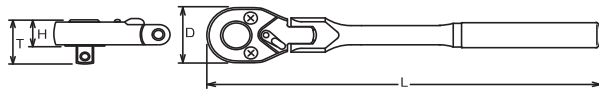

	D (mm)	T (mm)	H (mm)	L (mm)	(g)	(pce.)
4774N	38	36.2	21.6	330	700	1
4774P	38	36.2	21.6	330	700	1
4774J	38	36.2	21.6	330	685	1

**4774P-450** Flexible Ratchet, Reversible ⚠  
Llave de Carraca Flexible, Reversible



\* Renewal Kits → 4753RK → P287

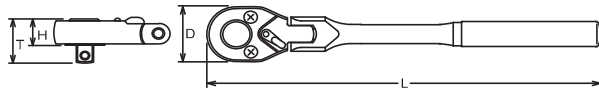

	D (mm)	T (mm)	H (mm)	L (mm)	(g)	(pce.)
4774P-450	38	36.2	21.6	450	790	1

⚠ 4774P-450 has longer handle than standard, and can be loaded to excessive torque value. In the interest of your own safety always apply load evenly and progressively to avoid breakage and possible injury.

# 1/2" Hand Sockets



\* Renewal Kits → 4753BRK → P287

## 4774NB

Flexible Ratchet, Reversible with Quick Release Button  
Llave de Carraca Flexible, Reversible con botón de extracción rápida



\* Renewal Kits → 4753BRK → P287

## 4774PB

Flexible Ratchet, Reversible with Quick Release Button  
Llave de Carraca Flexible, reversible con botón de extracción rápida



\* Renewal Kits → 4753BRK → P287

## 4774JB

Flexible Ratchet, Reversible with Quick Release Button  
Llave de Carraca Flexible, reversible con botón de extracción rápida



	D (mm)	T (mm)	H (mm)	L (mm)	⚖️ (g)	📦 (pce.)
4774NB	38	36.2	21.6	330	700	1
4774PB	38	36.2	21.6	330	700	1
4774JB	38	36.2	21.6	330	685	1

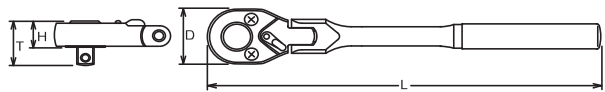

Reversible Ratchet with quick release button has less strength compared with normal ratchet due to the technical design. Make sure to use the ratchet correctly.



**Reversible Ratchet with Quick Release Button :**  
Sockets and accessories are safely locked.

By pushing the button the sockets or extension bars are released from the ratchet.

**Llave de Carraca Reversible con Botón de**

**Extracción Rápida :** Los vasos y accesorios se bloquean en posición. Los vasos o las alargaderas se extraen de la llave apretando el botón.

HAND  
MANUALES  
Z-SERIES  
TITANIUM  
DE TITANIO  
ACCESSORIES  
ACCESORIOS  
SCREWDRIVERS  
DESTORNILLADORES  
IMPACT  
DE IMPACTO  
SLEEVE-DRIVE  
INDUSTRIAL  
INDUSTRIALES  
PROTECTOR  
PROTECTORES  
AUTOMOTIVE  
CONSTRUCTION  
CONSTRUCCIÓN  
RENEWAL KITS  
JUEGOS DE PIEZAS REPUESTO

# Hand Sockets 1/2"

HAND  
MANUALES

Z-SERIES

TITANIUM  
DE TITANIO

ACCESSORIES  
ACCESORIOS

SCREWDRIVERS  
DESTORNILLADORES

IMPACT  
DE IMPACTO

SLEEVE-DRIVE

INDUSTRIAL  
INDUSTRIALES

PROTECTOR  
PROTECTORES

AUTOMOTIVE

CONSTRUCTION  
CONSTRUCCIÓN

RENEWAL KITS  
JUEGOS DE PIEZAS REPUESTO

## 4768N-300 Hinge Handle Mango Articulado

\* Renewal Kits → 4768RK → P288



## 4768N-380 • -450 Hinge Handle Mango Articulado

\* Renewal Kits → 4768RK → P288



## 4768P-380 • -450 Hinge Handle Mango Articulado

\* Renewal Kits → 4768RK → P288



## 4768J-380 • -450 Hinge Handle Mango Articulado

\* Renewal Kits → 4768RK → P288

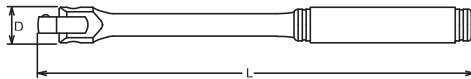

⚠ 4768-450 has longer handle than standard, and can be loaded to excessive torque value. Please use carefully.

	D (mm)	L (mm)	(g)	(pcs.)
4768N-300	28	300	600	2
4768N-380	28	380	696	2
4768N-450	28	450	784	2
4768P-380	28	380	665	2
4768P-450	28	450	748	2
4768J-380	28	380	600	1
4768J-450	28	450	690	1

## 4768N-600 Hinge Handle Mango Articulado

\* Renewal Kits → 4768RK → P288



## 4768P-600 Hinge Handle Mango Articulado

\* Renewal Kits → 4768RK → P288



## 4768J-600 Hinge Handle Mango Articulado

\* Renewal Kits → 4768RK → P288



⚠ 4768-600 has longer handle than standard, and can be loaded to excessive torque value. In the interest of your own safety always apply load evenly and progressively to avoid breakage and possible injury.

	D (mm)	L (mm)	(g)	(pcs.)
4768N-600	28	600	1100	1
4768P-600	28	600	1170	1
4768J-600	28	600	1120	1

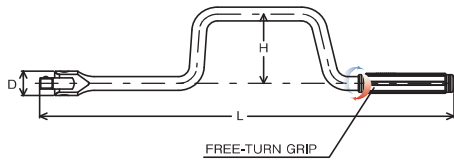

**4781N-450** Flexible Speed Handle  
Manivela Rápida Flexible



\* Renewal Kits → 4768RK → P288

	D (mm)	H (mm)	L (mm)	(g)	(pcs.)
4781N-450	28	80	450	1000	1

**4755** Ratchet Adaptor  
Adaptador de carraca

45

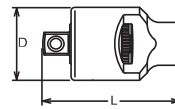

\* Renewal Kits → 4755RK → P288

	D (mm)	L (mm)	(g)	(pcs.)
4755	33.5	65	270	5

**4756** Quick Spinner  
Disco de Giro Rápido

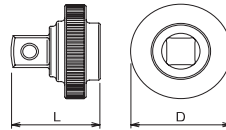

	D (mm)	L (mm)	(g)	(pcs.)
4756	38	34.5	95	10

**4770** Universal Joint  
Articulación Universal

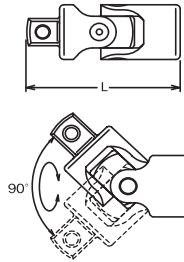

	L (mm)	(g)	(pcs.)
4770	62.4	150	10

**4771** Universal Joint  
Articulación Universal

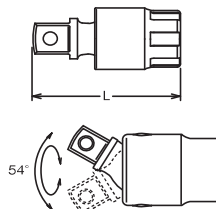

	L (mm)	(g)	(pcs.)
4771	57.7	113	10



# Hand Sockets 1/2"

4760-50 • -75 • -100 • -125 • -150 •  
-200 • -250 • -300 • -400 • -500 •  
-600 • -900 • -1000

Extension Bars  
Alargaderas

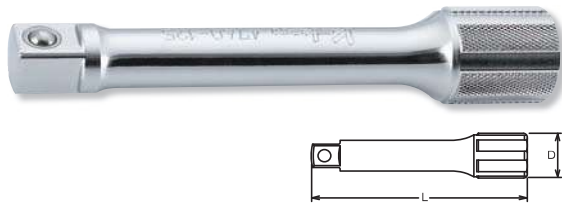

4760	D (mm)	L (mm)	(g)	(pcs.)
50	24	50	92	10
75	24	75	138	10
100	24	100	158	5
125	24	125	194	5
150	24	150	266	5
200	24	200	295	5
250	24	250	358	5
300	24	300	492	2
400	24	400	650	1
500	24	500	808	1
600	24	600	968	1
900	24	900	1430	1
1000	24	1000	1593	1

PK4760/5 Set Juego



PK4760/5	5 Pieces Set/Δ=1,050g
PLASTIC TRAY	
Extension Bars	
4760 Extension Bars 50, 75, 125, 150, 250	

4763-50 • -75 • -125 • -150 • -250 • -400

Wobble-Fix Extension Bars  
Alargaderas Articuladas-Fijas ⚠

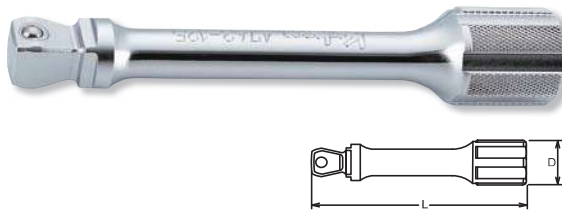

4763	D (mm)	L (mm)	(g)	(pcs.)
50	24	50	95	10
75	24	75	111	10
125	24	125	157	5
150	24	150	181	5
250	24	250	357	5
400	24	400	650	1

⚠ The Wobble-Fix Extension Bar has less strength than normal extension bar due to it's specific design with a reduced square drive. Make sure to use it correctly.

PK4763/5 Set Juego



PK4763/5	5 Pieces Set/Δ=950g
PLASTIC TRAY	
Extension Bars	
4763 Wobble-Fix Extension Bars 50, 75, 125, 150, 250	

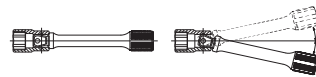

**Wobble-Fix Extension Bar**  
Two way usage : one for as a flexible extension bar to provide at 15° angle operation, the other for use as a normal extension bar. This usage is Patent.

**Alargadera Articulada-Fija**  
Dos formas de utilización : Una como alargadera flexible para poder trabajar con un ángulo de 15° y otra para utilizarse como alargadera normal. Esta aplicación está patentada.

4780-400 Speed Handle  
Manivela Rápida

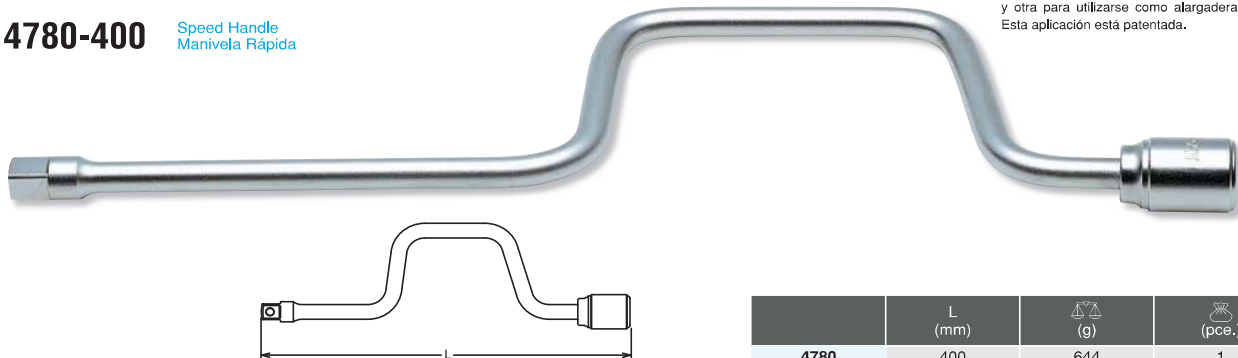

4780	L (mm)	(g)	(pcs.)
4780	400	644	1



**4785** T-Handle Mango Corredizo



Innovative Oval shaped bar provides higher durability and stops the sliding square part turning around the bar.

	L (mm)	(g)	(pcs.)
4785	300	410	2

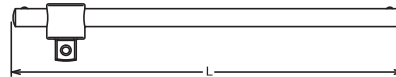

**4747** L-Handle Mango Acodado



	L1 (mm)	L2 (mm)	(g)	(pcs.)
4747	260	50	470	1

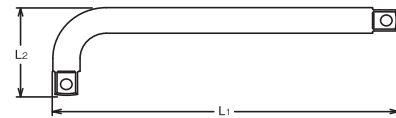

**4788-250 · -300 · -450** L-Handles Mango Acodado



	L1 (mm)	L2 (mm)	(g)	(pcs.)
4788				
250	250	53	417	2
300	300	53	503	1
450	450	53	745	1



**4433A-35 · -75 · -125 · -250 · -600**

Adaptors Adaptadores Warranty 290Nm Garantía 290Nm ⚠

	(sq.)	(sq.)	L (mm)	(g)	(pcs.)
4433A					
35	1/2"	3/8"	35	50	10
75	1/2"	3/8"	75	120	10
125	1/2"	3/8"	125	164	5
250	1/2"	3/8"	250	275	5
600	1/2"	3/8"	600	530	1

New

⚠ Adapting down from bigger square drive to smaller square drive may lead to excessive torque and possibly cause breakage.

La adaptación de mayor a menor de un cuadrado conductor puede conducir a un par excesivo que puede causar roturas.

	(sq.)	(sq.)	L (mm)	(g)	(pcs.)
4466A	1/2"	3/4"	42	108	10



**4466A** Adaptor Adaptador

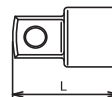

# Hand Sockets 1/2"

HAND  
MANUALES

Z-SERIES

TITANIUM  
DE TITANIO

ACCESSORIES  
ACCESORIOS

SCREWDRIVERS  
DESTORNILLADORES

IMPACT  
DE IMPACTO

SLEEVE-DRIVE

INDUSTRIAL  
INDUSTRIALES

PROTECTOR  
PROTECTORES

AUTOMOTIVE

CONSTRUCTION  
CONSTRUCCIÓN



RENEWAL KITS  
JUEGOS DE PIEZAS REFUESTO

**4222M** Socket Set  
Juego de Vasos

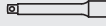

4222M 13 Pieces Set/Δ=2,780g

METAL CASE:W415xH120xT50mm



Sockets	Accessories
<b>4405M</b> 12-pt. Sockets 10, 11, 12, 13, 14, 17, 19, 21, 22, 24	 <b>4753N</b>  <b>4760-125</b>  <b>4770</b>

**4223M** Socket Set  
Juego de Vasos

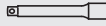

4223M 15 Pieces Set/Δ=2,600g

METAL CASE:W415xH120xT50mm



Sockets	Accessories
<b>4405M</b> 12-pt. Sockets 10, 11, 12, 13, 14, 15, 16, 17, 18, 19, 21, 22	 <b>4753N</b>  <b>4760-125</b>  <b>4770</b>

**4227M** Bit Socket Set  
Juego de Vasos con Punta



4227M 10 Pieces Set/Δ=2,550g

METAL CASE:W310xH150xT50mm



Sockets	Accessories
<b>4012M.75</b> Hex Bit Sockets 5, 6, 8, 10, 12, 14, 17	 <b>4749N-250</b>  <b>4760-75</b>  <b>4760-125</b>

**4230M · 4230A** Socket Sets  
Juegos de Vasos



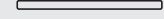

4230M 17 Pieces Set/Δ=3,150g

METAL CASE:W395xH90xT50mm

Sockets	Accessories
<b>4405M</b> 12-pt. Sockets 9, 10, 12, 13, 14, 15, 16, 17, 18, 19, 21, 23, 26	 <b>4753N</b>  <b>4760-125</b>  <b>4768N-380</b>  <b>4710</b>

4230A 17 Pieces Set/Δ=3,150g

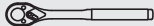
METAL CASE:W395xH90xT50mm

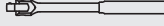
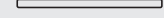

Sockets	Accessories
<b>4405A</b> 12-pt. Sockets 3/8, 7/16, 1/2, 9/16, 19/32, 5/8, 11/16, 3/4, 25/32, 13/16, 7/8, 15/16, 1	 <b>4753N</b>  <b>4760-125</b>  <b>4768N-380</b>  <b>4710</b>

**4232M** Socket Set  
Juego de Vasos

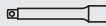

4232M 16 Pieces Set/Δ=3,300g

METAL CASE:W415xH120xT50mm

Sockets	Accessories
<b>4405M</b> 12-pt. Sockets 8, 9, 10, 12, 13, 14, 17, 19, 21, 22, 23, 24, 26	 <b>4753N</b>  <b>4760-125</b>  <b>4768N-380</b>



# 1/2" Hand Sockets

**4240M-00 · 4240A-00**  
**4240M-05 · 4240A-05**

○ Display Stands  
 Expositores

4240M-00	4400M	32 Pieces Set/△=4,400g
4240M-05	4405M	32 Pieces Set/△=4,400g
DISPLAY STAND:W410xH160xT500mm		
Sockets		
<b>Sockets (2pcs.each)</b>		
10, 11, 12, 13, 14, 15, 16, 17, 19, 21, 22, 23, 24, 27, 30, 32		
4240A-00	4400A	32 Pieces Set/△=4,700g
4240A-05	4405A	32 Pieces Set/△=4,700g
DISPLAY STAND:W410xH160xT500mm		
Sockets		
<b>Sockets (2pcs.each)</b>		
3/8, 7/16, 1/2, 9/16, 19/32, 5/8, 11/16, 3/4, 13/16, 7/8, 15/16, 1, 1.1/16, 1.1/8, 1.3/16, 1.1/4		



**S4240M-00 · S4240A-00**  
**S4240M-05 · S4240A-05**

○ Display Stands  
 Expositores

S4240M-00	4400M	117 Pieces Set/△=13,000g
S4240M-05	4405M	117 Pieces Set/△=13,000g
DISPLAY STAND:W510xH150xT230mm		
Sockets		
10mm:9pcs	16mm:9pcs	24mm:6pcs
11mm:9pcs	17mm:8pcs	27mm:5pcs
12mm:9pcs	19mm:7pcs	30mm:5pcs
13mm:9pcs	21mm:7pcs	32mm:4pcs
14mm:9pcs	22mm:6pcs	
15mm:9pcs	23mm:6pcs	
S4240A-00	4400A	103 Pieces Set/△=13,000g
S4240A-05	4405A	103 Pieces Set/△=13,000g
DISPLAY STAND:W510xH150xT230mm		
Sockets		
3/8" :9pcs	11/16":8pcs	1" :5pcs
7/16":9pcs	3/4" :7pcs	1.1/16":5pcs
1/2" :9pcs	13/16":7pcs	1.1/8" :5pcs
9/16":9pcs	7/8" :6pcs	1.3/16":5pcs
5/8" :9pcs	15/16":6pcs	1.1/4" :4pcs



HAND  
 MANUALES  
 Z-SERIES  
 TITANIUM  
 DE TITANIO  
 ACCESORIES  
 ACCESORIOS  
 SCREWDRIVERS  
 DESTORNILLADORES  
 IMPACT  
 DE IMPACTO  
 SLEEVE-DRIVE  
 INDUSTRIAL  
 INDUSTRIALES  
 PROTECTOR  
 PROTECTORES  
 AUTOMOTIVE  
 CONSTRUCTION  
 CONSTRUCCIÓN  
 RENEVAL KITS  
 JUEGOS DE PIEZAS REPUESTO

# Hand Sockets 1/2"

HAND  
MANUALES

Z-SERIES

TITANIUM  
DE TITANIO

ACCESSORIES  
ACCESORIOS

SCREWDRIVERS  
DESTORNILLADORES

IMPACT  
DE IMPACTO

SLEEVE-DRIVE  
SLEEVES

INDUSTRIAL  
INDUSTRIALES

PROTECTOR  
PROTECTORES

AUTOMOTIVE

CONSTRUCTION  
CONSTRUCCIÓN

RENEWAL KITS  
JUEGOS DE PIEZAS REPUESTO

## 4238AM Socket Set Juego de Vasos



4238AM 38 Pieces Set/Δ7=8,050g

METAL CASE:W446xH266xT50mm

Sockets	Accessories
<b>4405M</b> 12-pt. Sockets 10, 11, 12, 13, 14, 15, 16, 17, 18, 19, 21, 22, 23, 24, 26, 27, 30, 32	<b>4753N</b>
	<b>4760-125</b>
	<b>4760-250</b>
<b>4405A</b> 12-pt. Sockets 3/8, 7/16, 1/2, 9/16, 5/8, 11/16, 3/4, 13/16, 7/8, 15/16, 1.1/16, 1.1/8, 1.1/4	<b>4770</b>
	<b>4780</b>
<b>4300C</b> Spark Plug Socket 20.8	<b>4785</b>

## 4241M Socket Set Juego de Vasos



4241M 28 Pieces Set/Δ7=6,500g

METAL CASE:W445xH190xT50mm

Sockets	Accessories
<b>4405M</b> 12-pt. Sockets 10, 11, 12, 13, 14, 15, 16, 17, 18, 19, 20, 21, 22, 23, 24, 25, 26, 27, 28, 29, 30, 32	<b>4753N</b>
	<b>4760-125</b>
	<b>4760-250</b>
	<b>4768N-380</b>
	<b>4770</b>
	<b>4785</b>

## 4241A Socket Set Juego de Vasos



4241A 19 Pieces Set/Δ7=5,350g

METAL CASE:W445xH190xT50mm

Sockets	Accessories
<b>4405A</b> 12-pt. Sockets 3/8, 7/16, 1/2, 9/16, 5/8, 11/16, 3/4, 13/16, 7/8, 15/16, 1.1/16, 1.1/8, 1.1/4	<b>4753N</b>
	<b>4760-125</b>
	<b>4760-250</b>
	<b>4768N-380</b>
	<b>4770</b>
	<b>4785</b>

## 4244M · 4244A Socket Sets Juegos de Vasos



4244M 22 Pieces Set/Δ7=5,500g

METAL CASE:W445xH190xT50mm





Sockets	Accessories
<b>4405M</b> 12-pt. Sockets 9, 10, 12, 13, 14, 15, 16, 17, 18, 19, 21, 23, 26, 29, 32	<b>4753N</b>
	<b>4760-125</b>
	<b>4760-250</b>
	<b>4768N-380</b>
	<b>4770</b>
	<b>4785</b>
	<b>4710</b>



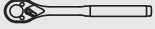

4244A 22 Pieces Set/Δ7=5,650g

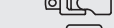
METAL CASE:W445xH190xT50mm

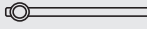
Sockets	Accessories
<b>4405A</b> 12-pt. Sockets 3/8, 7/16, 1/2, 9/16, 19/32, 5/8, 11/16, 3/4, 25/32, 13/16, 7/8, 15/16, 1, 1.1/8, 1.1/4	<b>4753N</b>
	<b>4760-125</b>
	<b>4760-250</b>
	<b>4768N-380</b>
	<b>4770</b>
	<b>4785</b>
	<b>4710</b>

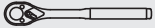
# 1/2" Hand Sockets

<b>4248M</b> 24 Pieces Set/Δ=5,700g	
METAL CASE:W445xH190xT50mm	
Sockets	Accessories
<b>4405M</b> 12-pt. Sockets 10, 11, 12, 13, 14, 15, 16, 17, 18, 19, 21, 22, 23, 24, 26, 27, 30, 32	 <b>4753N</b>  <b>4760-125</b>  <b>4760-250</b>  <b>4770</b>  <b>4780</b>  <b>4785</b>







<b>4250M</b> 18 Pieces Set/Δ=3,700g	
METAL CASE:W445xH190xT50mm	
Sockets	Accessories
<b>4405M</b> 12-pt. Sockets 10, 11, 12, 13, 14, 15, 17, 19, 22, 24, 27, 30, 32	 <b>4753N</b>  <b>4760-125</b>  <b>4760-250</b>  <b>4770</b>  <b>4785</b>

<b>4251M</b> 22 Pieces Set/Δ=3,200g	
METAL CASE:W330xH68xT48mm	
Sockets	
<b>4405M</b> 12-pt. Sockets 10, 11, 12, 13, 14, 15, 16, 17, 18, 19, 20, 21, 22, 23, 24, 25, 26, 27, 28, 29, 30, 32	

<b>4251A</b> 18 Pieces Set/Δ=2,660g	
METAL CASE:W330xH68xT48mm	
Sockets	
<b>4405A</b> 12-pt. Sockets 3/8, 7/16, 1/2, 9/16, 5/8, 19/32, 21/32, 11/16, 3/4, 25/32, 13/16, 7/8, 15/16, 1, 1.1/16, 1.1/8, 1.3/16, 1.1/4	

<b>4252M</b> 13 Pieces Set/Δ=1,200g	
METAL CASE:W168xH60xT42mm	
Sockets	
<b>4405M</b> 12-pt. Sockets 10, 11, 12, 13, 14, 15, 16, 17, 18, 19, 20, 21, 22	

<b>4252A</b> 13 Pieces Set/Δ=1,300g	
METAL CASE:W168xH60xT42mm	
Sockets	
<b>4405A</b> 12-pt. Sockets 3/8, 7/16, 1/2, 9/16, 19/32, 5/8, 21/32, 11/16, 3/4, 25/32, 13/16, 7/8, 15/16	

<b>4254</b> 12 Pieces Set/Δ=1,070g	
METAL CASE:W215xH80xT47mm	
Sockets	Accessories
 <b>3425-</b> E6, E8  <b>4425-</b> E10, E12, E14  <b>3325-</b> E6, E8  <b>4325-</b> E10, E12, E14	 <b>4763-50</b>  <b>4433A-35</b>

**4248M** Socket Set  
Juego de Vasos



**4250M** Socket Set  
Juego de Vasos



**4251M · 4251A** Socket Sets  
Juegos de Vasos



**4252M · 4252A** Socket Sets  
Juegos de Vasos



**4254** Socket Set  
Juego de Vasos



HAND  
MANUALES  
Z-SERIES  
TITANIUM  
DE TITANIO  
ACCESSORIES  
ACCESORIOS  
SCREWDRIVERS  
DESTORNILLADORES  
IMPACT  
DE IMPACTO  
SLEEVE-DRIVE  
INDUSTRIAL  
INDUSTRIALES  
PROTECTOR  
PROTECTORES  
AUTOMOTIVE  
CONSTRUCTION  
CONSTRUCCIÓN  
RENEWAL KITS  
JUEGOS DE PIEZAS REPUESTO

# Hand Sockets 1/2"

HAND  
MANUALES

Z-SERIES

TITANIUM  
DE TITANIO

ACCESSORIES  
ACCESORIOS

SCREWDRIVERS  
DESTORNILLADORES

IMPACT  
DE IMPACTO

SLEEVE-DRIVE

INDUSTRIAL  
INDUSTRIALES

PROTECTOR  
PROTECTORES



AUTOMOTIVE

CONSTRUCTION  
CONSTRUCCIÓN

RENEWAL KITS  
JUEGOS DE PIEZAS REPUESTO



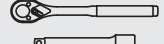
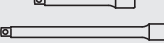
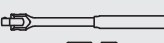

## 4261M Socket Set Juego de Vasos



4261M		18 Pieces Set/Δ=4,870g	
METAL CASE:W445xH190xT50mm			
Sockets		Accessories	
 <b>4405M</b> 12-pt. Sockets 8, 10, 11, 12, 13, 14, 17, 19, 21, 22, 24, 26, 27			<b>4753N</b>
			<b>4760-125</b>
			<b>4760-250</b>
			<b>4768N-380</b>
			<b>4770</b>

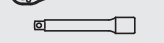
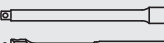

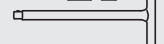
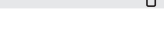

## 4263M Socket Set Juego de Vasos



4263M		21 Pieces Set/Δ=6,100g	
METAL CASE:W445xH190xT50mm			
Sockets		Accessories	
 <b>4405M</b> 12-pt. Sockets 8, 10, 11, 12, 13, 14, 15, 17, 19, 21, 22, 23, 24, 26, 27			<b>4753N</b>
			<b>4760-125</b>
			<b>4760-250</b>
			<b>4768N-380</b>
			<b>4770</b>
			<b>4715S</b>

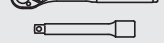

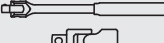
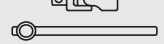
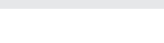

## 4273AM Socket Set Juego de Vasos





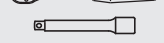
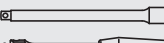



4273AM		30 Pieces Set/Δ=6,940g	
METAL CASE:W446xH266xT50mm			
Sockets		Accessories	
 <b>4405M</b> 12-pt. Sockets 10, 11, 12, 13, 14, 17, 19, 21, 22, 23, 24, 26, 27			<b>4753N</b>
			<b>4760-125</b>
 <b>4405A</b> 12-pt. Sockets 3/8, 7/16, 1/2, 9/16, 5/8, 11/16, 3/4, 13/16, 7/8, 15/16, 1			<b>4760-250</b>
			<b>4768N-380</b>
			<b>4770</b>
			<b>4785</b>

## P4241M-01 Socket Sets P4241M-06 Juegos de Vasos



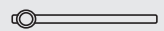

P4241M-01		28 Pieces Set/Δ=6,400g	
PLASTIC CASE:W425xH332xT65mm			
Sockets		Accessories	
 <b>4401M</b> 6-pt. Sockets 10, 11, 12, 13, 14, 15, 16, 17, 18, 19, 20, 21, 22, 23, 24, 25, 26, 27, 28, 29, 30, 32			<b>4753J</b>
			<b>4760-125</b>
			<b>4760-250</b>
			<b>4768J-380</b>
			<b>4770</b>
			<b>4785</b>

P4241M-06		28 Pieces Set/Δ=6,400g	
PLASTIC CASE:W425xH332xT65mm			
Sockets		Accessories	
 <b>4406M</b> 12-pt. Sockets 10, 11, 12, 13, 14, 15, 16, 17, 18, 19, 20, 21, 22, 23, 24, 25, 26, 27, 28, 29, 30, 32			<b>4753J</b>
			<b>4760-125</b>
			<b>4760-250</b>
			<b>4768J-380</b>
			<b>4770</b>
			<b>4785</b>

# 1/2" Hand Sockets

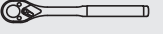
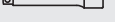
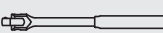
HAND  
MANUALES  
Z-SERIES  
TITANIUM  
DE TITANIO  
ACCESSORIES  
ACCESORIOS  
SCREWDRIVERS  
DESTORNILLADORES  
IMPACT  
DE IMPACTO  
SLEEVE-DRIVE  
INDUSTRIAL  
INDUSTRIALES  
PROTECTOR  
PROTECTORES  
AUTOMOTIVE  
CONSTRUCTION  
CONSTRUCCIÓN  
RENEWAL KITS  
JUEGOS DE REPARACIÓN

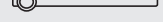
4275		24 Pieces Set/Δ▽=5,340g	
METAL CASE:W445xH190xT50mm			
Sockets	Accessories		
<p><b>4400M</b> 6-pt. Sockets 10, 11, 12, 13, 14, 15, 16, 17, 18, 19, 21, 22, 24</p> <p><b>4300C</b> Spark Plug Sockets 16, 20.8</p> <p><b>4300M</b> Wheel Nut Sockets 17(L60), 19(L60), 21(L60)</p>	    	<p><b>4750N</b></p> <p><b>4760-125</b></p> <p><b>4760-250</b></p> <p><b>4768N-380</b></p> <p><b>4770</b></p> <p><b>4785</b></p>	

**4275** Socket Set  
Juego de Vasos

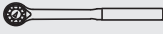
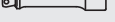

4276		17 Pieces Set/Δ▽=2,890g	
METAL CASE:W370xH150xT50mm			
Sockets	Accessories		
<p><b>4010M.50</b> Bit Sockets 6, 7, 8, 10, 12, 14</p> <p><b>4025.60</b> TORX® Bit Sockets T20, T25, T27, T30, T40, T45, T50, T55, T60</p>	 	<p><b>4752N</b></p> <p><b>4763-125</b></p>	



**4276** Socket Set  
Juego de Vasos

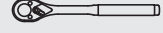
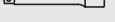
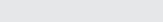

4277		27 Pieces Set/Δ▽=5,660g	
METAL CASE:W445xH190xT50mm			
Sockets	Accessories		
<p><b>4405M</b> 12-pt. Sockets 10, 12, 13, 14, 15, 16, 17, 18, 19, 21, 22, 24</p> <p><b>4305M</b> 12-pt. Deep Sockets 10, 12, 13, 14, 15, 16, 17, 18, 19, 21, 22, 24</p>	  	<p><b>4750N</b></p> <p><b>4760-125</b></p> <p><b>4768N-380</b></p>	

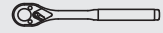
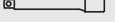

**4277** Socket Set  
Juego de Vasos

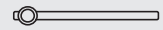

4279AM		36 Pieces Set/Δ▽=6,000g	
METAL CASE:W445xH190xT50mm			
Sockets	Accessories		
<p><b>4405M</b> 12-pt. Sockets 10, 11, 12, 13, 14, 15, 16, 17, 18, 19, 21, 22, 23, 24, 26, 27, 30, 32</p> <p><b>4405A</b> 12-pt. Sockets 3/8, 7/16, 1/2, 9/16, 5/8, 11/16, 3/4, 13/16, 7/8, 15/16, 1.1/16, 1.1/8, 1.1/4</p>	   	<p><b>4753N</b></p> <p><b>4760-125</b></p> <p><b>4760-250</b></p> <p><b>4770</b></p> <p><b>4785</b></p>	

**4279AM** Socket Set  
Juego de Vasos

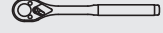
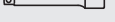

4289M		18 Pieces Set/Δ▽=4,200g	
METAL CASE:W445xH190xT50mm			
Sockets	Accessories		
<p><b>4405M</b> 12-pt. Sockets 8, 10, 12, 13, 14, 17, 19, 21, 22, 24, 27, 30, 32</p>	   	<p><b>4753N</b></p> <p><b>4760-125</b></p> <p><b>4760-250</b></p> <p><b>4768N-450</b></p> <p><b>4771</b></p>	

**4289M** Socket Set  
Juego de Vasos

