

HAND  
MANUALES

Z-SERIES

TITANIUM  
DE TITANIO

ACCESSORIES  
ACCESORIOS

SCREWDRIVERS  
DESTORNILLADORES

IMPACT  
DE IMPACTO

SLEEVE-DRIVE

INDUSTRIAL  
INDUSTRIALES

PROTECTOR  
PROTECTORES

AUTOMOTIVE

RENEWAL KITS  
JUEGOS DE PIEZAS REPUESTO  
CONSTRUCCIÓN

## 4100M • 4100A

 Screw and Stud Pullers  
Extractores de Espárragos y Tornillos

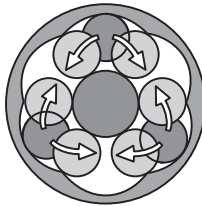
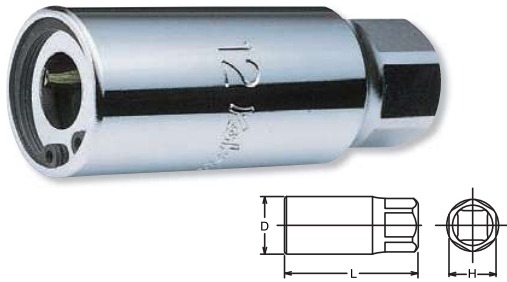

**Screw and Stud Pullers**  
Hexagon body design can lessen the excessive load on cages and rollers inside the pullers.

**Extractores de Tornillos y Espárragos**  
El diseño hexagonal del cuerpo evita cargas excesivas en las celdas y rodillos internos del extractor.

4100M (mm)		D (mm)	L (mm)	H (mm)	(g)	(pcs.)
5	1/2"	24	65	21	145	10
6		24	65	21	150	10
7		24	65	21	150	10
8		24	65	21	147	10
9		28	75	21	217	10
10		28	75	21	213	10
10.5		28	75	21	202	10
11		28	75	21	218	10
12		28	75	21	220	10
14		34	75	27	340	5
16	-⚠	34	75	27	315	5

4100A (inch)		D (mm)	L (mm)	H (mm)	(g)	(pcs.)
1/4	1/2"	24	65	21	150	10
5/16		24	65	21	147	10
3/8		28	75	21	213	10
7/16		28	75	21	218	10
1/2		28	75	21	191	10
9/16		34	75	27	340	5
5/8	-⚠	34	75	27	315	5

\* Renewal Kits → 4100MRK/4100ARK → P289

⚠ 4100M-16 and 4100A-5/8 do not have 1/2" square drive.  
Drive the outer hexagon part with 27mm sockets or ring wrenches.

4100M-16 y 4100A-5/8 no tienen conductores cuadrados de 1/2"  
Apretar la parte hexagonal exterior con vasos de 27mm o llaves de tuerca.

Tolerance/Tolerancia

	4100M (mm)		4100A (inch)
5	4.7- 5	1/4	6 - 6.4
6	5.6- 6	5/16	7.6- 8
7	6.6- 7	3/8	9 - 9.6
8	7.6- 8	7/16	10.5-11.1
9	8.4- 9	1/2	12.1-12.7
10	9.4-10	9/16	13.5-14.3
10.5	9.9-10.5	5/8	15.2-16
11	10.4-11		
12	11.4-12		
14	13.2-14		
16	15.2-16		

## 4211M • 4211A

 Screw and Stud Pullers Sets  
Juegos de Extractores de Tornillos y Espárragos



4211M 4 Pieces Set/Δ=1,040g  
METAL CASE:W215xH80xT47mm

PULLER

 4100M Stud Pullers  
6, 8, 10, 12

4211A 4 Pieces Set/Δ=1,040g  
METAL CASE:W215xH80xT47mm

PULLER

 4100A Stud Pullers  
1/4, 5/16, 3/8, 1/2

## 4214M

 Screw and Stud Pullers Set  
Juegos de Extractores de Tornillos y Espárragos



4214M 5 Pieces Set/Δ=1,450g  
METAL CASE:W215xH80xT47mm

PULLER

 4100M Stud Pullers  
6, 8, 10, 12, 14

6100M (mm)		D (mm)	L (mm)	H (mm)	(g)	(pcs.)
18	3/4"	48	100	36	840	1
20		48	100	36	816	1
22		48	100	36	745	1
24	⚠	48	100	36	739	1
27		63	125	46	1707	1
28		63	125	46	1701	1
29		63	125	46	1696	1
30		63	125	46	1691	1

\* Renewal Kits → 6100MRK → P289

⚠ 6100M-22 to -30 do not have 3/4" square drive.  
Drive the outer hexagon part with sockets or ring wrenches (size 22-24mm = 36H, 27-30mm = 46H).

6100M-22-30 no tienen conductores cuadrados de 3/4"  
Apretar la parte hexagonal exterior con vasos o llaves de tuerca (medidas 22-24mm = 36H, 27-30mm = 46H)

Tolerance/Tolerancia

6100M (mm)	
18	16.9-18
20	18.8-20
22	20.8-22
24	22.7-24
27	25.7-27
28	26.7-28
29	27.6-29
30	28.6-30

14100M (mm)		D <sub>1</sub> (mm)	D <sub>2</sub> (mm)	L (mm)	(g)	(pcs.)	
6	1/2"	24	25	48	126	10	*1
7		24	25	48	126	10	*1
8		24	25	48	122	10	*1
9		28	30	48	181	10	*2
10		28	30	48	181	10	*2
12		28	30	48	175	10	*2

14100A (inch)		D <sub>1</sub> (mm)	D <sub>2</sub> (mm)	L (mm)	(g)	(pcs.)	
1/4	1/2"	24	25	48	126	10	*1
5/16		24	25	48	122	10	*1
3/8		28	30	48	181	10	*2
7/16		28	30	48	181	10	*2
1/2		28	30	48	180	10	*2

\*1 C-Ring=1401C, Pin/O-Ring=1401A/B  
\*2 C-Ring=1402C, Pin/O-Ring=1402A/B

→ P238-239

Tolerance/Tolerancia

14100M (mm)		14100A (inch)
6	5.6- 6	1/4
7	6.6- 7	5/16
8	7.6- 8	3/8
9	8.4- 9	7/16
10	9.4-10	1/2
12	11.4-12	

6100M Screw and Stud Pullers  
Extractores de Tornillos y Espárragos

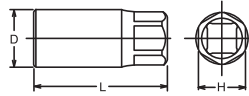

14100M • 14100A

Impact Screw and Stud Pullers  
Extractores de Tornillos y Espárragos de Impacto

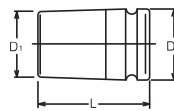

HAND MANUALES  
Z-SERIES  
TITANIUM DE TITANIO  
ACCESSORIES ACCESORIOS  
SCREWDRIVERS DESTORNILLADORES  
IMPACT DE IMPACTO  
SLEEVE-DRIVE INDUSTRIAL INDUSTRIALES  
PROTECTOR PROTECTORES  
AUTOMOTIVE  
CONSTRUCTION CONSTRUCCION  
RENEWAL KITS JUEGOS DE PIEZAS REPUESTO

# Stud Puller & Setter

HAND  
MANUALES

Z-SERIES

TITANIUM  
DE TITANIO

ACCESSORIES  
ACCESORIOS

SCREWDRIVERS  
DESTORNILLADORES

IMPACT  
DE IMPACTO

SLEEVE-DRIVE

INDUSTRIAL  
INDUSTRIALES

PROTECTOR  
PROTECTORES

AUTOMOTIVE

RENEWAL KITS  
JUEGOS DE PIEZAS REPUESTO  
CONSTRUCCIÓN

## 141S Stud Puller Ratchets Extractores de Espárragos de Carraca



141S (mm)	D (mm)	L (mm)	(g)	(pcs.)
6	28	120	150	1
8	28	120	150	1
10	32	120	153	1
12	32	120	152	1

141S (inch)	D (mm)	L (mm)	(g)	(pcs.)
5/16	28	120	150	1
3/8	32	120	153	1
1/2	32	120	152	1

## 141 Stud Puller Ratchets Extractores de Espárragos de Carraca



141 (mm)	D (mm)	L (mm)	(g)	(pcs.)
6	28	205	215	1
8	28	205	215	1
10	32	205	234	1
12	32	205	233	1

141 (inch)	D (mm)	L (mm)	(g)	(pcs.)
5/16	28	205	215	1
3/8	32	205	234	1
1/2	32	205	233	1

## 141P Stud Puller Ratchets Extractores de Espárragos de Carraca

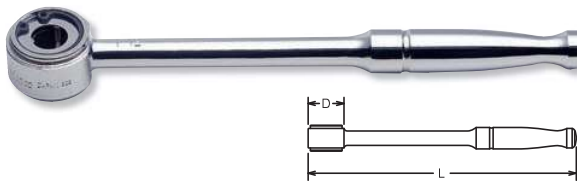

141P (mm)	D (mm)	L (mm)	(g)	(pcs.)
6	28	205	210	1
8	28	205	210	1
10	32	205	229	1
12	32	205	227	1

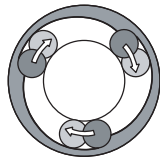

The three roller system can protect the studs from damage.

El sistema de tres rodillos puede proteger los espárragos de cualquier daño.



## 1201 Stud Puller Ratchets Set Juego de Extractores de Espárragos de Carraca



1201	4 Pieces Set/1.17=973g
METAL CASE:W240xH100xT32mm	
PULLER	
141S Stud Puller Ratchet 6, 8, 10, 12	

## 4104 Screw and Stud Puller Extractor de Tornillos y Espárragos



4104	1/2"	Tolerance		D (mm)	L (mm)	(g)	(pcs.)
		min	max				
		φ6	φ19	54	56	489	2

4103M (mm)	□	D <sub>1</sub> (mm)	D <sub>2</sub> (mm)	ℓ (mm)	L (mm)	⚖️ (g)	📦 (pcs.)
6(1.0)	1/2"	10.3	22	9	37	54	10
7(1.0)		11.5	22	10	37	58	10
8(1.25)		13.2	22	11	37	60	10
10(1.25)		15.3	23	13	44	86	10
10(1.5)		15.3	23	13	44	86	10
12(1.25)		17.8	23	14	44	86	10
12(1.75)		17.8	23	14	44	86	10

**4103M** Stud Bolt Setters  
Vasos para apretar pernos

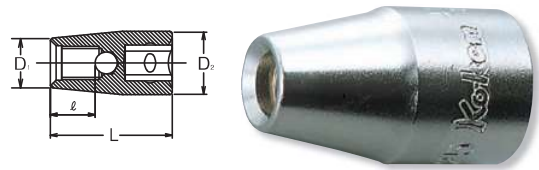

<b>4203M</b>	4 Pieces Set/Δ△=530g
METAL CASE:W130xH65xT26mm	
Stud Bolt Setter	
<b>4103M</b> Stud Bolt Setters	
6(1.0), 8(1.25), 10(1.5), 12(1.75)	

<b>4203MF</b>	4 Pieces Set/Δ△=530g
METAL CASE:W130xH65xT26mm	
Stud Bolt Setter	
<b>4103M</b> Stud Bolt Setters	
6(1.0), 8(1.25), 10(1.25), 12(1.25)	

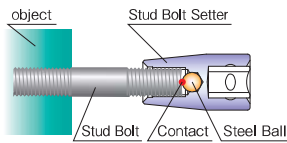

A special socket for installing a stud bolt. Inside steel ball prevent the stud bolt stuck onto the socket. After installing a stud bolt, turn to anti-clockwise to removing the socket.

**4203M** Stud Bolt Setters Set  
**4203MF** Juego de Vasos para apretar Pernos



13103M (mm)	□	D <sub>1</sub> (mm)	D <sub>2</sub> (mm)	ℓ (mm)	L (mm)	⚖️ (g)	📦 (pcs.)	⊘
5(0.8)	3/8"	9.5	19	8	32	39	10	*1
6(1.0)		10.8	19	9	32	41	10	*1
7(1.0)		12.5	19	10	32	44	10	*1
8(1.25)		13.5	19	11	35	49	10	*1
10(1.25)		15.8	19	13	35	49	10	*1
10(1.5)		15.8	19	13	35	49	10	*1

\*1 C-Ring=1301C, Pin/O-Ring=1301A/B → P238-239

**13103M** Impact Stud Bolt Setters  
Vasos para apretar Pernos de Impacto

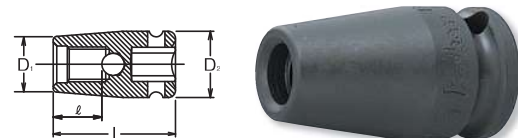

14103M (mm)	□	D <sub>1</sub> (mm)	D <sub>2</sub> (mm)	ℓ (mm)	L (mm)	⚖️ (g)	📦 (pcs.)	⊘
6(1.0)	1/2"	12	25	11	42	75	10	*1
7(1.0)		13.2	25	12	42	78	10	*1
8(1.25)		14.5	25	15	42	81	10	*1
10(1.25)		17	25	18	49	106	10	*1
10(1.5)		17	25	18	49	106	10	*1
12(1.25)		19.5	25	19	49	107	10	*1
12(1.75)		19.5	25	19	49	107	10	*1
14(1.5)		22	25	21	55	128	10	*1
14(2.0)	22	25	21	55	128	10	*1	

\*1 C-Ring=1401C, Pin/O-Ring=1401A/B → P238-239

**14103M** Impact Stud Bolt Setters  
Vasos para apretar Pernos de Impacto

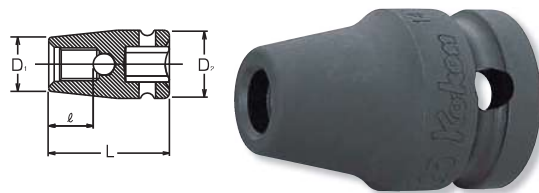

HAND MANUALES  
Z-SERIES  
TITANIUM DE TITANIO  
ACCESSORIES ACCESORIOS  
SCREWDRIVERS DESTORNILLADORES  
IMPACT DE IMPACTO  
SLEEVE-DRIVE  
INDUSTRIAL INDUSTRIALES  
PROTECTOR PROTECTORES  
AUTOMOTIVE  
CONSTRUCTION CONSTRUCCION  
RENEWAL KITS JUEGOS DE PIEZAS REEMPLAZO

HAND  
MANUALES

Z-SERIES

TITANIUM  
DE TITANIO

ACCESSORIES  
ACCESORIOS

SCREWDRIVERS  
DESTORNILLADORES

IMPACT  
DE IMPACTO

SLEEVE-DRIVE

INDUSTRIAL  
INDUSTRIALES

PROTECTOR  
PROTECTORES





AUTOMOTIVE

CONSTRUCTION  
CONSTRUCCIÓN

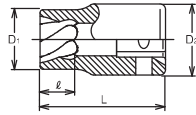
RENEWAL KITS  
JUEGOS DE PIEZAS REPUESTO

**2127**  NUTTWISTER®  
AFLOJA TUERCAS



2127 (mm)		D <sub>1</sub> (mm)	D <sub>2</sub> (mm)	l (mm)	L (mm)	 (g)	 (pcs.)
4		7	13	4	23	14	10
4.5		7.4	13	4	23	14	10
5		8	13	5	23	14	10
5.5		8.8	13	5	23	14	10
6		9.5	13	6	23	14	10
7		10.9	13	6	23	14	10
8		11.5	13	8	23	14	10
9		13	13	8	23	15	10
9.5		13.8	13	10	23	16	10
10		14.8	13	10	23	17	10

**RS2127/6**   Socket Set on Rail  
Juego de Vasos en Regleta



RS2127/6	6 Pieces Set/Rail 150mm	 (g)
4, 4.5, 5, 5.5, 6, 7		105





**RS2127/10**   Socket Set on Rail  
Juego de Vasos en Regleta

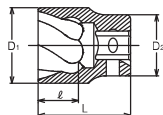

RS2127/10	10 Pieces Set/Rail 150mm	 (g)
4, 4.5, 5, 5.5, 6, 7, 8, 9, 9.5, 10		180

**3127**  NUTTWISTER®  
AFLOJA TUERCAS



3127 (mm)		D <sub>1</sub> (mm)	D <sub>2</sub> (mm)	l (mm)	L (mm)	 (g)	 (pcs.)
8		11.5	19	8	32	40	10
9		13	19	8	32	40	10
9.5		13.8	19	8	32	41	10
10		14.8	19	10	32	41	10
11		16	19	10	32	43	10
12		17	19	12	32	44	10
13		18.5	19	12	32	46	10
14		19.7	19	14	32	48	10
15		20.7	19	14	32	52	10
16		22.2	22	14	32	66	10
17	23.5	22	16	35	80	10	
19	26	22	16	35	92	10	

**RS3127/8**   Socket Set on Rail  
Juego de Vasos en Regleta



RS3127/8	8 Pieces Set/Rail 200mm	 (g)
8, 9, 10, 11, 12, 13, 14, 16		420

3128.80 (mm)		D <sub>1</sub> (mm)	D <sub>2</sub> (mm)	ℓ (mm)	L (mm)	 (g)	 (pcs.)
8	3/8"	11.5	19	6	80	58	10
9		13	19	6	80	61	10
10		14.8	19	8	80	66	10
11		16	19	8	80	70	10
12		17	19	10	80	77	10
13		18.5	19	10	80	80	10
14		19.7	19	12	80	82	10

**3128-80** NUTTWISTER® (Long type)  
AFLOJA TUERCAS (Serie Larga)

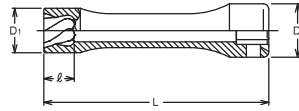

4127 (mm)		D <sub>1</sub> (mm)	D <sub>2</sub> (mm)	ℓ (mm)	L (mm)	 (g)	 (pcs.)
14	1/2"	19.7	30	14	42	125	5
17		23.5	30	16	42	137	5
19		26	30	16	42	146	5
21		28	30	17	42	153	5
22		29.5	30	17	42	158	5
24		32	30	18	42	174	5
25.4		33.5	30	18	42	183	5

**4127** NUTTWISTER®  
AFLOJA TUERCAS

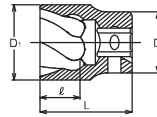

RS4127/6	6 Pieces Set/Rail 200mm	 (g)
17, 19, 21, 22, 24, 25.4		960

**RS4127/6** Socket Set on Rail  
Juego de Vasos en Regleta



**4128-120** NUTTWISTER® (Long type)  
AFLOJA TUERCAS (Serie Larga)

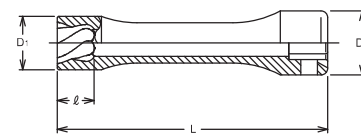

4128.120 (mm)		D <sub>1</sub> (mm)	D <sub>2</sub> (mm)	ℓ (mm)	L (mm)	 (g)	 (pcs.)
17	1/2"	23.5	30	16	120	227	10
19		26	30	16	120	247	10
21		28	30	17	120	262	10
22		29.5	30	17	120	259	10

A very effective method and easy solution for removing rounded off nuts, bolts and studs. The sharp edges of the NUTTWISTER® Socket opening will tighten around the nut, bolt or stud and turn it easily off.

Un método muy efectivo y una fácil solución para aflojar tuercas, pernos y espárragos redondeados por desgaste. Las afiladas aristas de la boca del vaso AFLOJA TUERCAS NUTTWISTER®, aprietan contra la tuerca, perno o espárrago, haciéndolo girar fácilmente.



HAND  
MANUALES  
Z-SERIES  
TITANIUM  
DE TITANIO  
ACCESSORIES  
ACCESORIOS  
SCREWDRIVERS  
DESTORNILLADORES  
IMPACT  
DE IMPACTO  
SLEEVE-DRIVE  
INDUSTRIAL  
INDUSTRIALES  
PROTECTOR  
PROTECTORES  
AUTOMOTIVE  
CONSTRUCTION  
RENEVAL KITS  
JUEGOS DE PIEZAS REPUESTO

HAND  
MANUALES

**3129-32** BOLTTWISTER®  
AFLOJA PERNOS

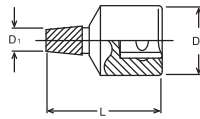

3129.32 (mm)	□	D <sub>1</sub> (mm)	D <sub>2</sub> (mm)	L (mm)	⚖️ (g)	📦 (pcs.)
2	3/8"	2	19	32	32	10
3		3	19	32	33	10
4		4	19	32	33	10
6		6	19	32	35	10
8		8	19	32	37	10
10		10	19	32	40	10

Z-SERIES

TITANIUM  
DE TITANIO

**RS3129/6-L32** Socket Set on Rail  
Juego de Vasos en Regleta



RS3129/6-L32	6 Pieces Set/Rail 150mm	⚖️ (g)
<b>2, 3, 4, 6, 8, 10</b>		250

ACCESSORIES  
ACCESORIOS

SCREWDRIVERS  
DESTORNILLADORES

**3129-60** BOLTTWISTER®  
AFLOJA PERNOS

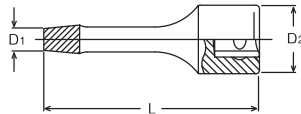

3129.60 (mm)	□	D <sub>1</sub> (mm)	D <sub>2</sub> (mm)	L (mm)	⚖️ (g)	📦 (pcs.)
2	3/8"	2	19	60	38	10
3		3	19	60	42	10
4		4	19	60	44	10
6		6	19	60	47	10
8		8	19	60	53	10
10		10	19	60	64	10

IMPACT  
DE IMPACTO

SLEEVE-DRIVE

**RS3129/6-L60** Socket Set on Rail  
Juego de Vasos en Regleta



RS3129/6-L60	6 Pieces Set/Rail 150mm	⚖️ (g)
<b>2, 3, 4, 6, 8, 10</b>		320

INDUSTRIAL  
INDUSTRIALES

PROTECTOR  
PROTECTORES

AUTOMOTIVE



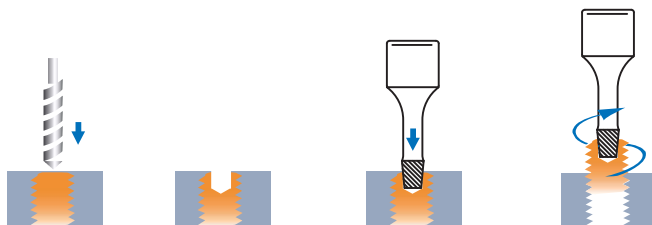

CONSTRUCTION  
CONSTRUCCIÓN



Effective method and easy solution for removing twisted off bolt. Drill a hole in the center of bolt and drive BOLTTWISTER® firmly into the hole. The sharp spiral edges will hold the broken bolt and easily remove it.

Un método efectivo y una fácil solución para aflojar pernos rotos. Taladrar un agujero en el centro del perno e introducir el AFLOJA PERNOS BOLTTWISTER® presionando y girando. Las afiladas aristas espirales agarran el perno roto sacándolo.

BOLTTWISTER	Bolt size	Drill size
2	M5	φ 2.4- 2.6
3	M6	φ 3.2- 3.5
4	M8	φ 4.2- 4.5
6	M10-M12	φ 6.2- 6.5
8	M14-M16	φ 8.2- 8.5
10	M18-M20	φ 10.2-10.5
12	M22-M24	φ 12.2-12.5
14	M27-M30	φ 14.2-14.5
16	M33	φ 16.2-16.5

4129.37 (mm)		D <sub>1</sub> (mm)	D <sub>2</sub> (mm)	L (mm)	 (g)	 (pcs.)
8		8	24	37	59	10
10		10	24	37	63	10
12		12	24	37	67	10
14		14	24	37	72	10
16		16	24	37	78	10



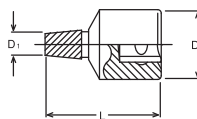

**4129-37** BOLTTWISTER®  
AFLOJA PERNOS



RS4129/5-L37	5 Pieces Set/Rail 150mm	 (g)
8, 10, 12, 14, 16		370

**RS4129/5-L37**  Socket Set on Rail  
Juego de Vasos en Regleta



4129.75 (mm)		D <sub>1</sub> (mm)	D <sub>2</sub> (mm)	L (mm)	 (g)	 (pcs.)
8		8	24	75	80	10
10		10	24	75	94	10
12		12	24	75	110	10
14		14	24	75	130	10
16		16	24	75	150	10

**4129-75** BOLTTWISTER®  
AFLOJA PERNOS

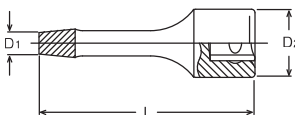

RS4129/5-L75	5 Pieces Set/Rail 150mm	 (g)
8, 10, 12, 14, 16		600

**RS4129/5-L75**  Socket Set on Rail  
Juego de Vasos en Regleta



HAND  
MANUALES

Z-SERIES

TITANIUM  
DE TITANIO

ACCESSORIES  
ACCESORIOS

SCREWDRIVERS  
DESTORNILLADORES

IMPACT  
DE IMPACTO

SLEEVE-DRIVE

INDUSTRIAL  
INDUSTRIALES

PROTECTOR  
PROTECTORES

AUTOMOTIVE

CONSTRUCTION  
CONSTRUCCION

RENEWAL KITS  
JUEGOS DE PIEZAS REPUESTO





# T-Type Wrench

RENEWAL KITS CONSTRUCCIÓN JUEGOS DE PIEZAS REPUESTO CONSTRUCCIÓN  
 AUTOMOTIVE  
 PROTECTOR PROTECTORES  
 INDUSTRIAL INDUSTRIALES  
 SLEEVE-DRIVE  
 IMPACT DE IMPACTO  
 SCREWDRIVERS DESTORNILLADORES  
 ACCESSORIES ACCESORIOS  
 TITANIUM DE TITANIO  
 Z-SERIES  
 HAND MANUALES

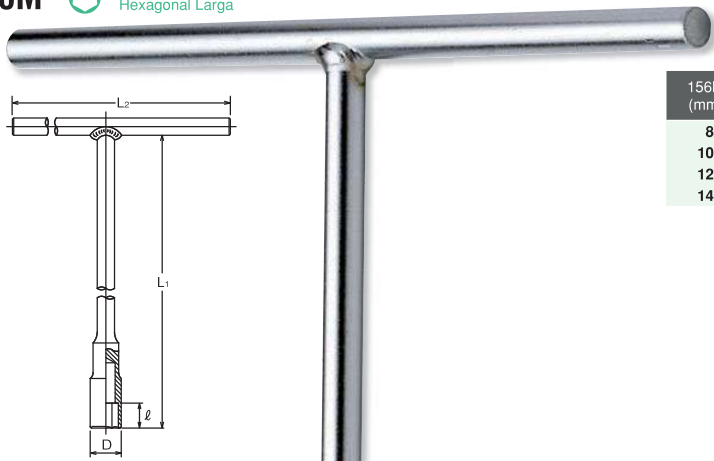

## 156M 6-point Deep Hexagonal Larga





156M (mm)	D (mm)	ℓ (mm)	L <sub>1</sub> (mm)	L <sub>2</sub> (mm)	 (g)	 (pce.)
8	12	9	355	200	231	1
10	14.5	11	355	200	289	1
12	16.8	13	355	200	429	1
14	20	16	355	200	454	1

## 104M · 104A 6-point Hexagonal



104M (mm)	D (mm)	ℓ (mm)	L <sub>1</sub> (mm)	L <sub>2</sub> (mm)	 (g)	 (pce.)
6	9.5	8	200	180	150	1
7	11	9	200	180	152	1
8	12	10	250	200	183	1
9	14	12	250	200	188	1
10	14	13	250	200	230	1
11	16	14	250	200	234	1
12	18	15	250	250	384	1
13	18.5	17	300	250	412	1
14	20	18	300	250	428	1
15	21	19	300	250	443	1
16	22.5	21	350	300	528	1
17	24	22	350	300	707	1
18	25	23	350	300	707	1
19	26.5	25	350	300	717	1
21	29	27	350	300	1070	1
22	30	28	350	300	1062	1
24	33	30	350	300	1140	1

104A (inch)	D (mm)	ℓ (mm)	L <sub>1</sub> (mm)	L <sub>2</sub> (mm)	 (g)	 (pce.)
1/4	9.5	8	200	180	150	1
5/16	12	10	250	200	183	1
3/8	14	12	250	200	188	1
7/16	16	14	250	200	234	1
1/2	18.5	17	300	250	412	1
9/16	20	18	300	250	428	1
5/8	22.5	21	350	300	528	1
3/4	26.5	25	350	300	717	1

**3116M**  Universal with 6-point Socket  
Con articulación universal con Vaso Hexagonal

**124M-600 (2B)**  Ball Joint plus Nut Grip Socket  
Con articulación de rótula y Vaso Sujeta Tuerca

3116M (mm)	D (mm)	ℓ (mm)	L <sub>1</sub> (mm)	L <sub>2</sub> (mm)	(g)	(pce.)
10	14.5	8	800	190	796	1
12	17	10.3	800	190	797	1
13	18	11.3	800	190	797	1
14	19.5	11.3	800	190	797	1
15	21	12.8	800	190	799	1
16	22	12.8	800	190	806	1
17	23.6	13.8	800	190	801	1
18	24	13.8	800	190	809	1

124M.600 (mm)	D (mm)	ℓ (mm)	L <sub>1</sub> (mm)	L <sub>2</sub> (mm)	(g)	(pce.)
8(2B)	12	5	600	200	332	1
10(2B)	14.5	6	600	200	334	1
12(2B)	16.8	7	600	200	424	1
13(2B)	18	8	600	200	425	1
14(2B)	19.5	8.5	600	200	527	1
17(2B)	23.3	9.5	600	200	538	1

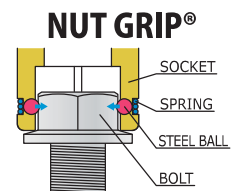
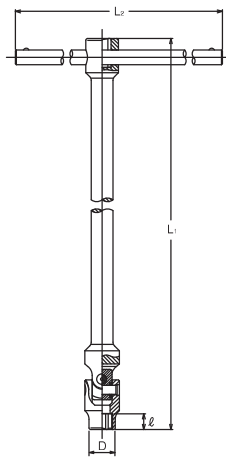

Twin balls at the 6-point opening hold bolt-nut tightly for safe and reliable work.

Las dos bolas de la boca Hexagonal sujetan el perno-tuerca permitiendo un trabajo seguro y fiable.

HAND MANUALES  
Z-SERIES  
TITANIUM DE TITANIO  
ACCESSORIES ACCESORIOS  
SCREWDRIVERS DESTORNILLADORES  
IMPACT DE IMPACTO  
SLEEVE-DRIVE  
INDUSTRIAL INDUSTRIALES  
PROTECTOR PROTECTORES  
AUTOMOTIVE  
CONSTRUCTION CONSTRUCCION  
RENEWAL KITS JUEGOS DE PIEZAS REEMPLAZO

# T-Type Wrench

HAND MANUALES  
Z-SERIES  
TITANIUM DE TITANIO  
ACCESSORIES ACCESORIOS  
SCREWDRIVERS DESTORNILLADORES  
IMPACT DE IMPACTO  
SLEEVE-DRIVE  
INDUSTRIAL INDUSTRIALES  
PROTECTOR PROTECTORES  
AUTOMOTIVE  
CONSTRUCTION CONSTRUCCIÓN  
RENEWAL KITS JUEGOS DE PIEZAS REPUESTO

## 157H For Inhex Screws Para Tornillos de Seis Lados en el Interior (Inhex)

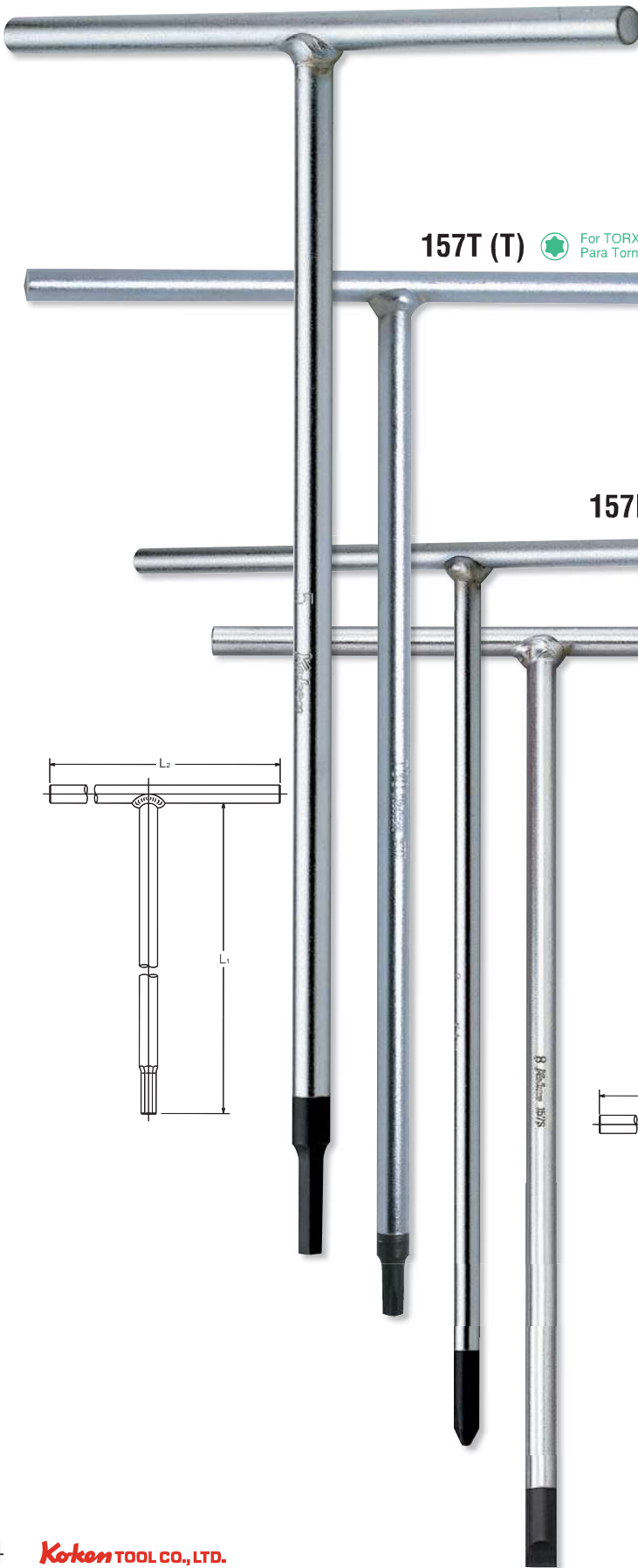

157H (mm)	L <sub>1</sub> (mm)	L <sub>2</sub> (mm)	(g)	(pce.)
3	160	100	57	1
4	200	120	70	1
5	250	160	90	1
6	300	190	147	1
7	300	190	193	1
8	300	190	245	1
10	300	190	433	1
12	320	210	662	1
14	340	220	879	1
17	340	220	1369	1

## 157T (T) For TORX® Screws Para Tornillos TORX®

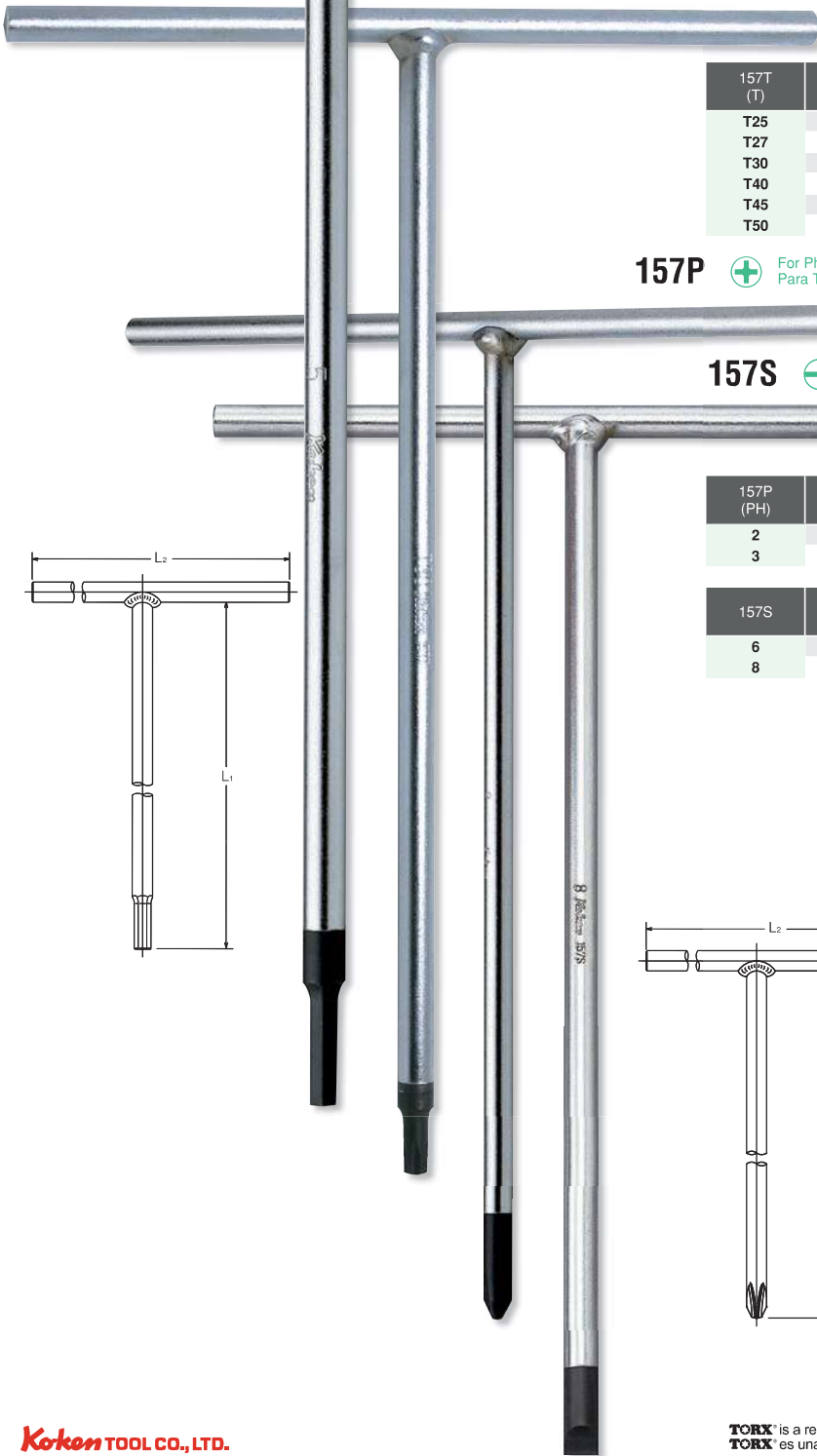

157T (T)	L <sub>1</sub> (mm)	L <sub>2</sub> (mm)	(g)	(pce.)
T25	250	180	95	1
T27	250	180	96	1
T30	250	180	167	1
T40	250	180	168	1
T45	250	180	213	1
T50	250	180	215	1

## 157P For Phillips Screws Para Tornillos Phillips



157P (PH)	L <sub>1</sub> (mm)	L <sub>2</sub> (mm)	(g)	(pce.)
2	200	180	84	1
3	300	180	189	1

157S	TxW	L <sub>1</sub> (mm)	L <sub>2</sub> (mm)	(g)	(pce.)
6	1.0x6	200	180	84	1
8	1.2x8	250	180	170	1

## 157S For Slotted Heads Para Cabezas Ranuradas

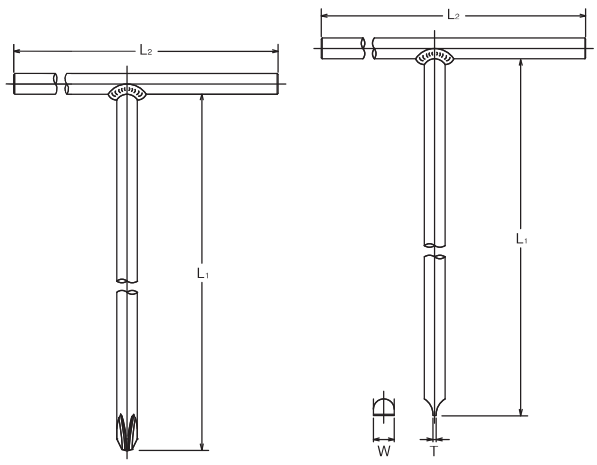
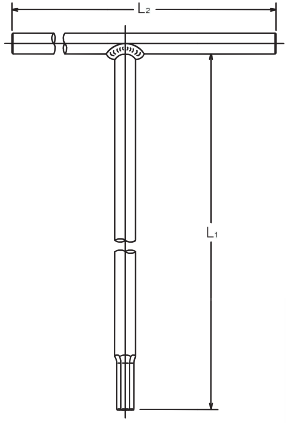

**2715**  T-Handle  
Llaves en T



**3715**  T-Handle  
Llaves en T

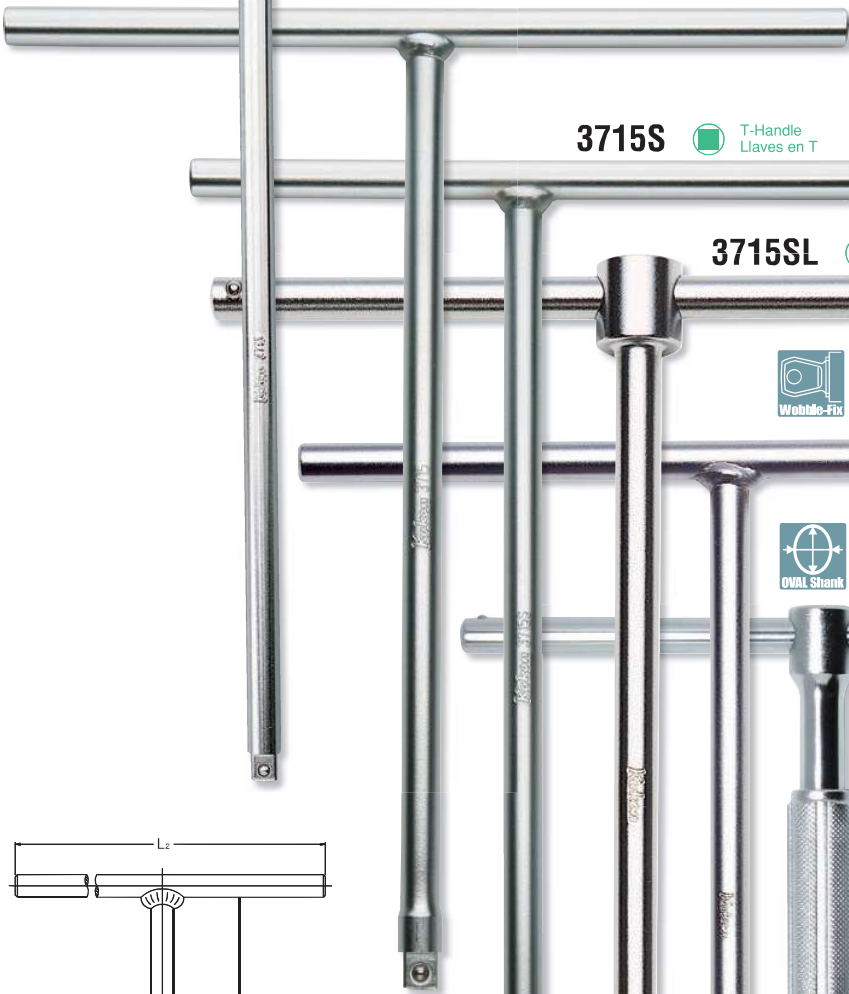

**3715S**  T-Handle  
Llaves en T



**3715SL**  T-Handle  
Llaves en T



**3716**  T-Handle  
Llaves en T 

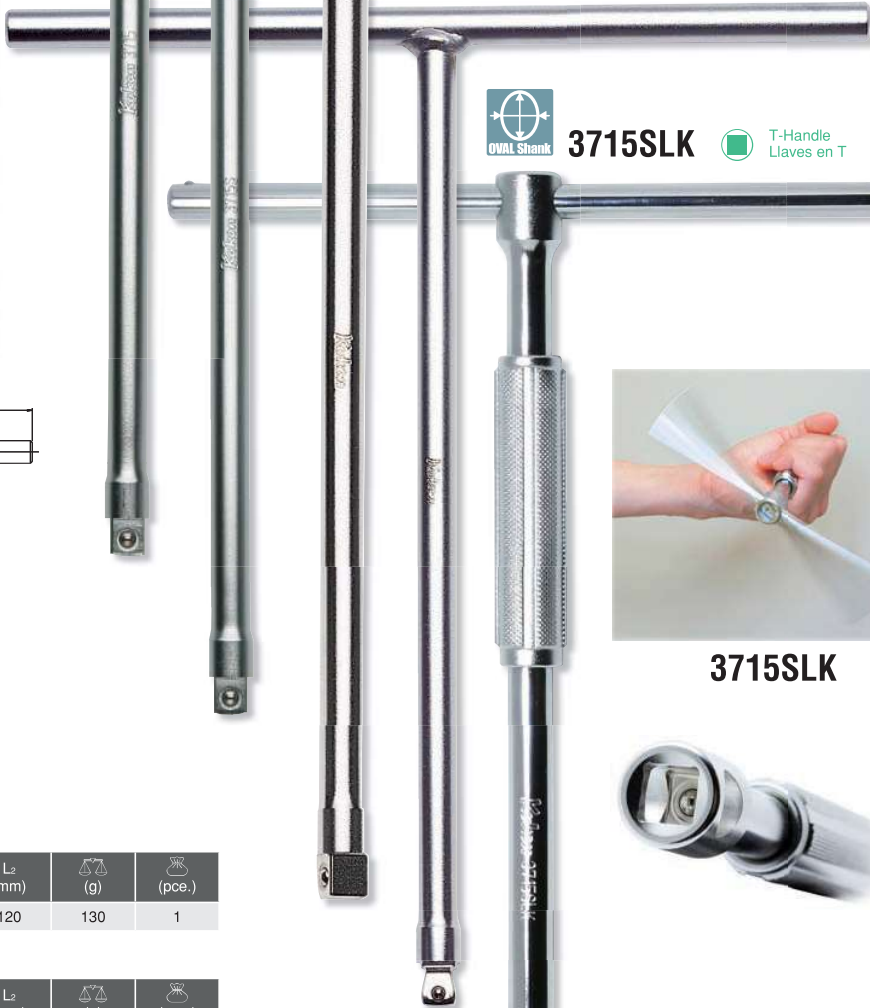



**3715SLK**  T-Handle  
Llaves en T

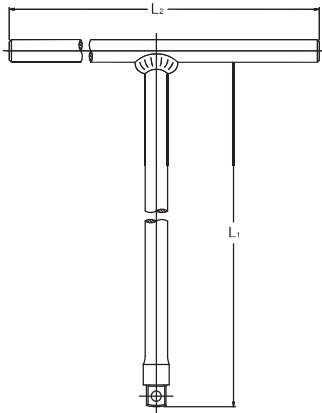

**3715SLK**



		L <sub>1</sub> (mm)	L <sub>2</sub> (mm)	 (g)	 (pce.)
<b>2715</b>	<b>1/4"</b>	200	120	130	1

		L <sub>1</sub> (mm)	L <sub>2</sub> (mm)	 (g)	 (pce.)
<b>3715</b>	<b>3/8"</b>	268	240	386	1
<b>3715S</b>		268	190	347	1
<b>3715SL</b>		237	200	325	1
<b>3715SLK</b>		236	200	470	1
<b>3716</b>		268	240	379	1

 **2715/3715/3716**  
This tool is used sockets in hard to reach places. 3716 has a reduced square drive and similar function as offset extension bars.

HAND  
MANUALES

Z-SERIES

TITANIUM  
DE TITANIO

ACCESSORIES  
ACCESORIOS

SCREWDRIVERS  
DESTORNILLADORES

IMPACT  
DE IMPACTO

SLEEVE-DRIVE

INDUSTRIAL  
INDUSTRIALES

PROTECTOR  
PROTECTORES

AUTOMOTIVE

CONSTRUCTION  
CONSTRUCCION

RENEWAL KITS  
JUEGOS DE PIEZAS REPUESTO

# T-Type Wrench

RENEWAL KITS CONSTRUCCIÓN  
 JUEGOS DE PIEZAS REPUESTO CONSTRUCCIÓN

AUTOMOTIVE

PROTECTOR PROTECTORES

INDUSTRIAL INDUSTRIALES

SLEEVE-DRIVE

IMPACT DE IMPACTO

SCREWDRIVERS DESTORNILLADORES

ACCESSORIES ACCESORIOS

TITANIUM DE TITANIO

Z-SERIES





HAND MANUALES

**4715**  T-Handle  
 Llaves en T

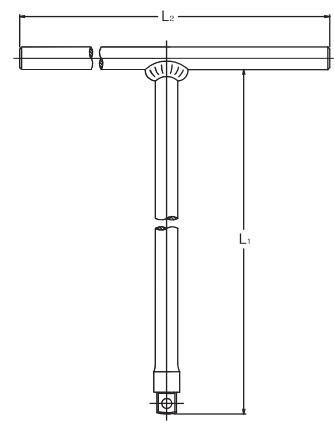
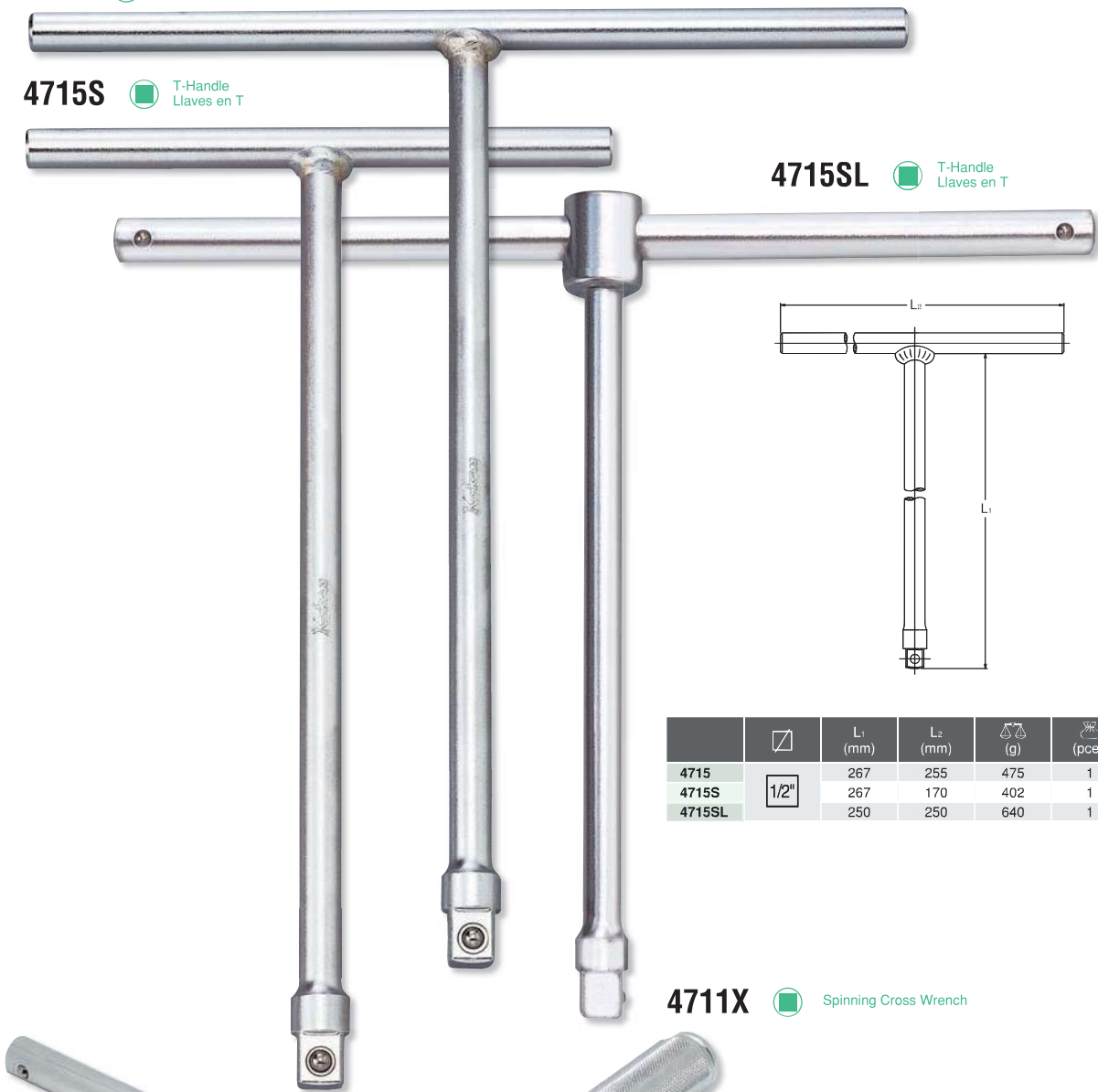
**4715S**  T-Handle  
 Llaves en T



**4715SL**  T-Handle  
 Llaves en T

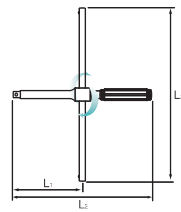
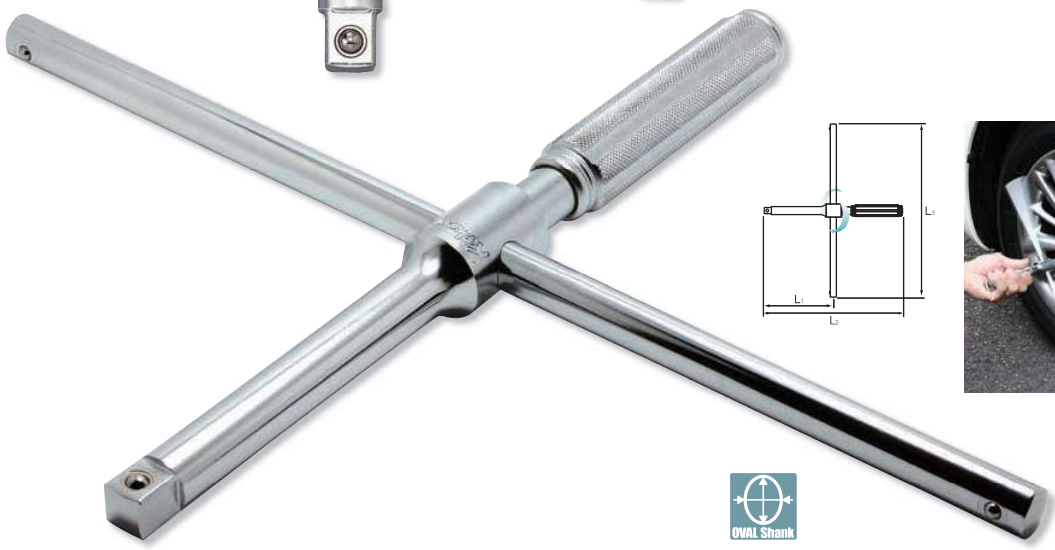

		L <sub>1</sub> (mm)	L <sub>2</sub> (mm)	 (g)	 (pce.)
<b>4715</b>		267	255	475	1
<b>4715S</b>		267	170	402	1
<b>4715SL</b>		250	250	640	1

**4711X**  Spinning Cross Wrench



		L <sub>1</sub> (mm)	L <sub>2</sub> (mm)	L <sub>3</sub> (mm)	 (g)	 (pce.)
<b>4711X</b>		140	280	350	945	1

3131A	□	S(mm)		L (mm)	⚖ (g)	📦 (pcs.)
		Min.	Max.			
1	3/8"	2.0	5.0	42	80	5
2		4.5	8.0	47	100	5

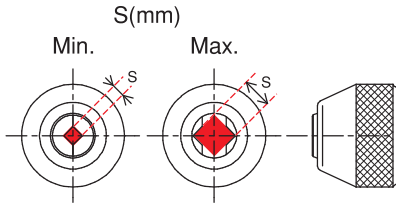

Tap is not included.

	□	C (mm)	L (mm)	⚖ (g)	📦 (pce.)
160K	3/8"	10	220	130	1
New 160K-1/2	1/2"	10	220	135	1

	□	S (mm)	D (mm)	H (mm)	ℓ (mm)	L (mm)	⚖ (g)	📦 (pcs.)
3132-20	3/8"	20	28	17	7	60	130	5
4132-25		25	34	22	9	60	170	2
4132-38	1/2"	38	48	24	13	80	315	2
4132-50		50	60	27	16	105	740	2



Die is not included.

**3131A** Tap Holder, Adjustable  
Adaptadores para machos de terrajas

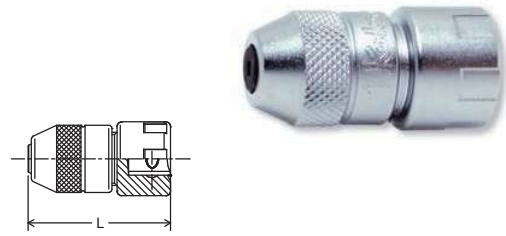

**160K** Handle  
Llave



**3132** Die Holder  
Adaptadores

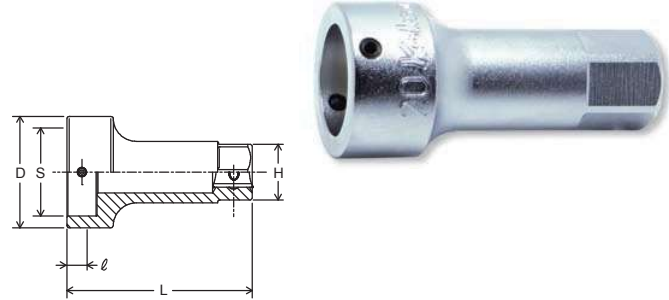

**4132** Die Holders  
Adaptadores





- HAND MANUALES
- Z-SERIES
- TITANIUM DE TITANIO
- ACCESSORIES ACCESORIOS
- SCREWDRIVERS DESTORNILLADORES
- IMPACT DE IMPACTO
- SLEEVE-DRIVE INDUSTRIAL INDUSTRIALES
- PROTECTOR PROTECTORES
- AUTOMOTIVE
- CONSTRUCTION CONSTRUCCION
- RENEWAL KITS JUEGOS DE PIEZAS REEMPLISTO

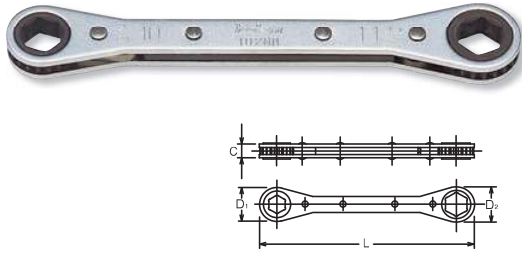

# Ratcheting Ring Wrench

HAND MANUALES  
Z-SERIES  
TITANIUM DE TITANIO  
ACCESSORIES ACCESORIOS  
SCREWDRIVERS DESTORNILLADORES  
IMPACT DE IMPACTO  
SLEEVE-DRIVE  
INDUSTRIAL INDUSTRIALES  
PROTECTOR PROTECTORES  
AUTOMOTIVE  
CONSTRUCTION CONSTRUCCIÓN  
RENEWAL KITS JUEGOS DE PIEZAS REPUESTO

## 102NM · 102NA Without Reverse Lever Sin palanca de inversión





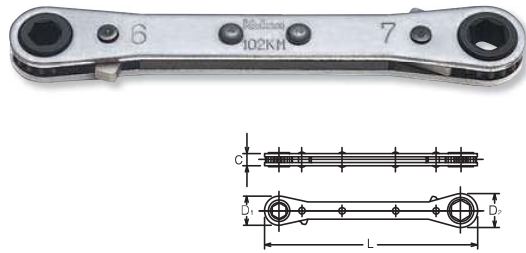

102NM (mm)	L (mm)	D <sub>1</sub> (mm)	D <sub>2</sub> (mm)	C (mm)	 (g)	 (pcs.)
6x7	108	15.3	16.4	7.5	60	10
7x8	108	15.3	16.4	7.5	60	10
8x9	134	17.1	19.7	7.5	80	10
8x10	134	17.1	19.7	7.5	80	10
10x11	140	20.1	22.7	7.5	87	10
10x12	140	20.1	22.7	7.5	87	10
12x13	145	23.6	24.6	9	112	10
12x14	145	23.6	24.6	9	112	10

102NA (inch)	L (mm)	D <sub>1</sub> (mm)	D <sub>2</sub> (mm)	C (mm)	 (g)	 (pcs.)
7/32 x 1/4	108	15.3	16.4	7.5	60	10
1/4 x 9/32	108	15.3	16.4	7.5	60	10
1/4 x 5/16	108	15.3	16.4	7.5	60	10
5/16 x 11/32	134	17.1	19.7	7.5	80	10
5/16 x 3/8	134	17.1	19.7	7.5	80	10
3/8 x 7/16	140	20.1	22.7	7.5	87	10
7/16 x 1/2	145	23.6	24.6	9	112	10
1/2 x 9/16	145	23.6	24.6	9	112	10

## 102KM · 102KA Reversible Reversible





102KM (mm)	L (mm)	D <sub>1</sub> (mm)	D <sub>2</sub> (mm)	C (mm)	 (g)	 (pcs.)
6x7	108	15.3	16.4	7.2	51	10
7x8	108	15.3	16.4	7.2	51	10
8x9	134	17	20	9.1	76	10
8x10	134	17	20	9.1	76	10
10x11	141	21	23.5	9.1	84	10
10x12	141	21	23.5	9.1	84	10
12x13	146	24	25	9.1	89	10
12x14	146	24	25	9.1	89	5
13x17	200	27.1	31.8	11.5	190	5
14x17	200	27.1	31.8	11.5	200	5

102KA (inch)	L (mm)	D <sub>1</sub> (mm)	D <sub>2</sub> (mm)	C (mm)	 (g)	 (pcs.)
7/32 x 1/4	108	15.3	16.4	7.2	51	10
1/4 x 5/16	108	15.3	16.4	7.2	51	10
3/8 x 7/16	141	21	23.5	9.1	84	10
1/2 x 9/16	146	24	25	9.1	89	10

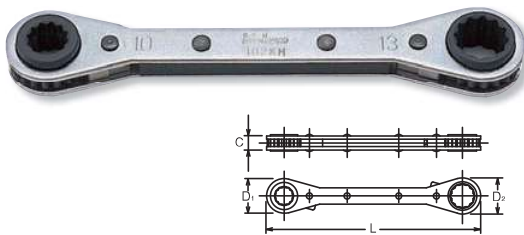
## 102KM (BH) With Twin Openings (Two-in-One) Con Bocas Gemelas (Dos en Uno)



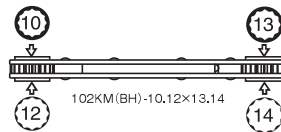

102KM BH (mm)	L (mm)	D <sub>1</sub> (mm)	D <sub>2</sub> (mm)	C (mm)	 (g)	 (pcs.)
5.5 · 6 x 7 · 8	108	15.3	16.4	10	60	10
8 · 10 x 12 · 13	141	21	23.5	13	87	10
9 · 10 x 11 · 12	141	21	23.5	13	87	10
10 · 12 x 13 · 14	146	24	25	13	98	5
13 · 14 x 15 · 17	200	27.1	31.8	16	200	5

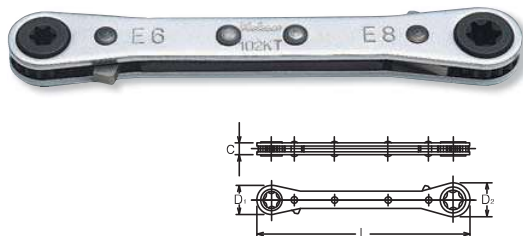

## 102KT Reversible TORX® Reversible TORX®



102KT (E)	L (mm)	D <sub>1</sub> (mm)	D <sub>2</sub> (mm)	C (mm)	 (g)	 (pcs.)
E 4xE 6	108	15.3	16.4	7.5	51	10
E 6xE 8	108	15.3	16.4	7.5	51	10
E 10xE 12	134	17	20	9	76	10

103KM (mm)	L (mm)	D <sub>1</sub> (mm)	D <sub>2</sub> (mm)	C (mm)	(g)	(pcs.)
6x 7	108	15.3	16.4	7.5	51	5
7x 8	108	15.3	16.4	7.5	51	5
8x 9	134	17	20	9	76	5
8x10	134	17	20	9	76	5
10x11	140	21	23.5	9	84	5
10x12	140	21	23.5	9	84	5
12x13	145	24	25	9	89	5
12x14	145	24	25	9	89	5

103KA (inch)	L (mm)	D <sub>1</sub> (mm)	D <sub>2</sub> (mm)	C (mm)	(g)	(pcs.)
7/32x 1/4	108	15.3	16.4	7.5	51	5
1/4 x 5/16	108	15.3	16.4	7.5	51	5
5/16x11/32	134	17	20	9	76	5
3/8 x 7/16	140	21	23.5	9	84	5
1/2 x 9/16	145	24	25	9	89	5

103KT (E)	L (mm)	D <sub>1</sub> (mm)	D <sub>2</sub> (mm)	C (mm)	(g)	(pcs.)
E 4xE 6	104	15.3	16.4	7.5	51	5
E 6xE 8	104	15.3	16.4	7.5	51	5
E10xE12	128	17	20	9	76	5
E14xE16	139	24	25	9	89	5

R810 (inch)	L (mm)	D <sub>1</sub> (mm)	D <sub>2</sub> (mm)	C (mm)	(g)	(pcs.)
1/4x5/16	108	15.3	16.4	7.5	60	10
3/8x7/16	140	20.1	22.7	7.5	87	10
1/2x9/16	145	23.6	24.6	9	112	10

**103KM · 103KA** Reversible

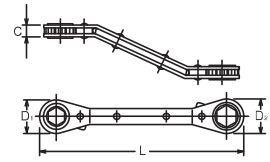

**103KT** Reversible TORX®

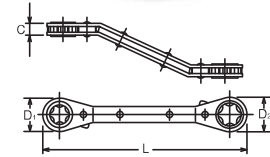

**R810** Reversible

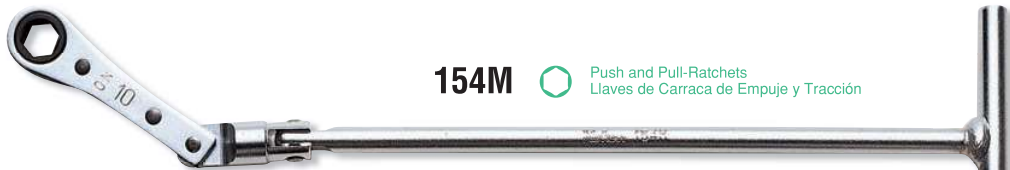
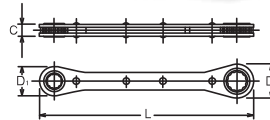

**154M** Push and Pull-Ratchets  
Llaves de Carraca de Empuje y Tracción

154M (mm)	L (mm)	D (mm)	C (mm)	(g)	(pcs.)
8	294	17.1	7.5	178	2
10	297	20.1	7.5	183	2
12	300	23.6	9	189	2
13	301	24.6	9	194	2
14	301	24.6	9	194	2

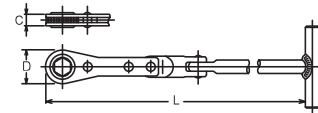

**154ML** Push and Pull-Ratchets  
Llaves de Carraca de Empuje y Tracción

154ML (mm)	L (mm)	D (mm)	C (mm)	(g)	(pcs.)
10	297	20.1	7.5	230	2
12	300	23.6	9	252	2

HAND MANUALES  
Z-SERIES  
TITANIUM DE TITANIO  
ACCESSORIES ACCESORIOS  
SCREWDRIVERS DESTORNILLADORES  
IMPACT DE IMPACTO  
SLEEVE-DRIVE INDUSTRIAL INDUSTRIALES  
PROTECTOR PROTECTORES  
AUTOMOTIVE  
CONSTRUCTION CONSTRUCCION  
RENEWAL KITS JUEGOS DE PIEZAS REPUESTO



# Ratcheting Ring Wrench

HAND  
MANUALES

Z-SERIES

TITANIUM  
DE TITANIO

ACCESSORIES  
ACCESORIOS

SCREWDRIVERS  
DESTORNILLADORES

IMPACT  
DE IMPACTO

SLEEVE-DRIVE

INDUSTRIAL  
INDUSTRIALES

PROTECTOR  
PROTECTORES

AUTOMOTIVE

CONSTRUCTION  
CONSTRUCCIÓN

RENEWAL KITS  
JUEGOS DE PIEZAS REPUESTO

**137**  For 1/4" and 3/8" Square Drive Sockets  
Para Vasos con Conductor Cuadrado de 1/4" y 3/8"

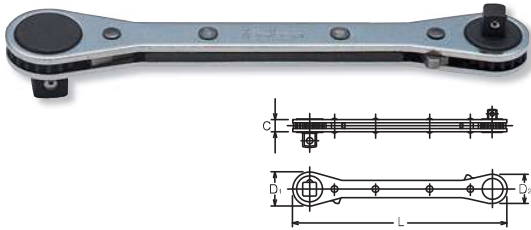

	L (mm)	D <sub>1</sub> (mm)	D <sub>2</sub> (mm)	C (mm)	(g)	(pcs.)
<b>137</b>	141	23.5	21	9	104	5

1/4" × 3/8"

**138**   For Bits 101  
Para Puntas 101

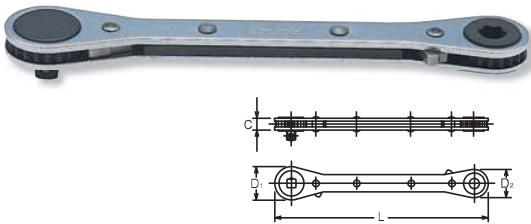

	L (mm)	D <sub>1</sub> (mm)	D <sub>2</sub> (mm)	C (mm)	(g)	(pcs.)
<b>138</b>	141	23.5	21	9	97	10

1/4" × 1/4"

**139**  For 1/4" Square Drive Sockets  
Para Vasos con Conductor Cuadrado de 1/4"

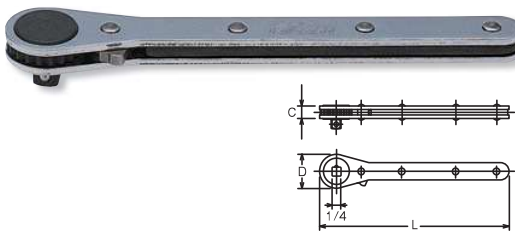

	L (mm)	D (mm)	C (mm)	(g)	(pcs.)
<b>139</b>	125	20.1	7.5	80	10

1/4"



**145KM-10H**  Reversible, 10mm 6-point  
Reversible, 10mm Hexagonal

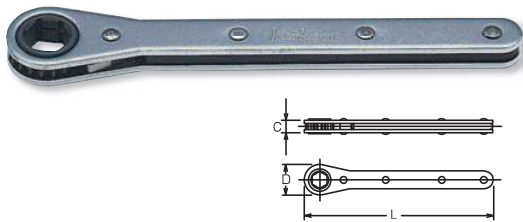

145KM (mm)	L (mm)	D (mm)	C (mm)	(g)	(pcs.)
<b>10H</b>	125	20.1	7.5	72	10

**150-10H**  Sockets with 10mm 6-point Drive End  
Vasos con Conductor Hexagonal 10mm





150.10H (mm)	D (mm)	ℓ (mm)	L (mm)	(g)	(pcs.)
<b>5</b>	12	3.5	11	6	10
<b>6</b>	12	4.5	12.5	7	10
<b>7</b>	12	5	14	7	10
<b>8</b>	12	6	15.5	7	10
<b>9</b>	13	6	16	7	10
<b>10</b>	14.3	7	17	9	10

**1203**  Sockets with 10mm 6-point Drive End in Set with Ratchet  
Juego de Vasos con Conductor Hex con Llave de Carraca



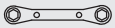



1203		7 Pieces Set/SET=250g
METAL CASE:W130xH65xT20mm		
Sockets		Accessory
 <b>150.10H</b> 5, 6, 7, 8, 9, 10	<b>145KM-10H</b>	

<b>R810A</b> 5 Pieces Set/SET=208g	
METAL CASE:W130xH65xT20mm	
Bits	Accessory
 <b>101P</b> Phillips Bits 1, 2, 3	 <b>102NA-1/4x5/16</b>
 <b>101S</b> Slotted Bit 1x7	





**R810A** Bit Set  
Juego de Puntas



<b>R810B</b> 10 Pieces Set/SET=268g	
METAL CASE:W130xH65xT20mm	
Bits	Accessory
 <b>101P</b> Phillips Bits 1, 2, 3	 <b>102NA-1/4x5/16</b>
 <b>101S</b> Slotted Bit 1x7	
 <b>128H</b> Hex Bits 3, 4, 5, 6, 8	

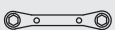





**R810B** Bit Set  
Juego de Puntas



<b>R810C</b> 12 Pieces Set/SET=227g	
METAL CASE:W130xH65xT20mm	
Bits, Sockets	Accessories
 <b>101P</b> Phillips Bits 1, 2, 3	 <b>102NA-1/4x5/16</b>
 <b>101S</b> Slotted Bit 1x7	
 <b>2400M</b> Sockets 5, 6, 7, 8, 9, 10	 <b>101A</b>



**R810C** Bit and Socket Set  
Juego de Puntas y Vasos



<b>R810D</b> 17 Pieces Set/SET=336g	
METAL CASE:W130xH65xT20mm	
Bits, Sockets	Accessories
 <b>101P</b> Phillips Bits 1, 2, 3	 <b>102NA-1/4x5/16</b>
 <b>101S</b> Slotted Bit 1x7	
 <b>128H</b> Hex Bits 3, 4, 5, 6, 8	 <b>101A</b>
 <b>2400M</b> Sockets 5, 6, 7, 8, 9, 10	

**R810D** Bit and Socket Set  
Juego de Puntas y Vasos



<b>R810E</b> 9 Pieces Set/SET=445g	
METAL CASE:W130xH65xT20mm	
Sockets	Accessories
 <b>2300M</b> Deep Sockets 6, 7, 8, 9, 10, 11, 12	 <b>102NA-1/4x5/16</b>
	 <b>101A</b>

**R810E** Socket Set  
Juego de Vasos



HAND  
MANUALES

Z-SERIES

TITANIUM  
DE TITANIO

ACCESSORIES  
ACCESORIOS

SCREWDRIVERS  
DESTORNILLADORES

IMPACT  
DE IMPACTO

SLEEVE-DRIVE

INDUSTRIAL  
INDUSTRIALES

PROTECTOR  
PROTECTORES

AUTOMOTIVE

CONSTRUCTION  
CONSTRUCCION

RENEWAL KITS  
JUEGOS DE HERRAS REEMPLAZO

# Ratcheting Ring Wrench

HAND  
MANUALES

Z-SERIES

TITANIUM  
DE TITANIO

ACCESSORIES  
ACCESORIOS

SCREWDRIVERS  
DESTORNILLADORES

IMPACT  
DE IMPACTO

SLEEVE-DRIVE

INDUSTRIAL  
INDUSTRIALES

PROTECTOR  
PROTECTORES

AUTOMOTIVE

RENEWAL KITS  
JUEGOS DE PIEZAS REPUESTO

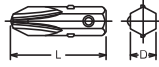

## 101P Phillips Bits Puntas Phillips



101P (PH)	D (mm)	L (mm)	 (g)	 (pcs.)
1	6.35	20.5	3	10
2	6.35	20.5	4	10
3	6.35	20.5	5	10

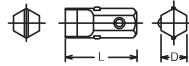

## 101S Bits for Slotted Head Puntas Rectas/Planas



101S	D (mm)	L (mm)	 (g)	 (pcs.)
1.0x7	6.35	15	3	10
1.2x7	6.35	15	3	10

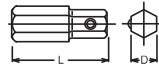

## 101H Hex Bits Puntas Hexagonales

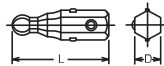

101H (mm)	D (mm)	L (mm)	 (g)	 (pcs.)
3	6.35	20.5	5	10
4	6.35	20.5	5	10
5	6.35	20.5	5	10
6	6.35	20.5	5	10
7	6.35	20.5	6	10
8	6.35	20.5	7	10

## 101B Ball point Hex Bits Puntas Hexagonales con bola





101B (mm)	D (mm)	L (mm)	 (g)	 (pcs.)
3	6.35	25	4	10
4	6.35	25	4	10
5	6.35	25	5	10
6	6.35	25	5	10

 Ball point bits have less strength due to the special design. Make sure to use them correctly.

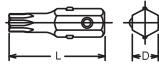

## 101T (T) TORX® Bits Puntas TORX®

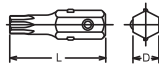

101T (T)	D (mm)	L (mm)	 (g)	 (pcs.)
T 9	6.35	25	4	10
T10	6.35	25	4	10
T15	6.35	25	5	10
T20	6.35	25	5	10
T25	6.35	25	5	10
T27	6.35	25	6	10
T30	6.35	25	6	10

## 101T (TH) Tamper-Resistant TORX® Bits Punta TORX®, indeformable







101T (TH)	D (mm)	L (mm)	 (g)	 (pcs.)
T10H	6.35	25	4	10
T15H	6.35	25	4	10
T20H	6.35	25	5	10
T25H	6.35	25	5	10
T27H	6.35	25	6	10
T30H	6.35	25	6	10





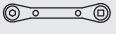

 Tamper Resistant TORX® Bits have less strength due to special design. Make sure to use it correctly.

128H (mm)	D (mm)	L (mm)	(g)	(pcs.)
3	8	32	11	10
4	8	32	11	10
5	8	32	12	10
6	8	32	12	10
8	8	32	13	10

128T (T)	D (mm)	L (mm)	(g)	(pcs.)
T10	8	32	9	10
T15	8	32	9	10
T20	8	32	9	10
T25	8	32	10	10
T27	8	32	10	10
T30	8	32	11	10

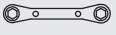
101A	D (mm)	S (mm)	L (mm)	(g)	(pcs.)
	8	6.35	20	8	10

1202		15 Pieces Set/ 1.5=420g
METAL CASE:W190xH60xT30mm		
Bits	Accessory	
<ul style="list-style-type: none"> <li> <b>101P</b> Phillips Bits 1, 2, 3</li> <li> <b>101S</b> Slotted Bit 1x7</li> <li> <b>101B</b> Ballpoint Hex Bits 3, 4, 5, 6</li> <li> <b>101T</b> Torx® Bits T10, T15, T20, T25, T27, T30</li> </ul>	 <b>138</b>	

2254M		12 Pieces Set/ 1.5=450g
METAL CASE:W160xH100xT28mm		
Bits	Accessories	
<ul style="list-style-type: none"> <li> <b>101P</b> Phillips Bits 1, 2, 3</li> <li> <b>101S</b> Slotted Bits 1x7, 1.2x7</li> <li> <b>101H</b> Hex Bits 3, 4, 5</li> </ul>	<ul style="list-style-type: none"> <li> <b>102NA-1/4x5/16</b></li> <li> <b>2769F</b></li> <li> <b>101A</b></li> <li> <b>2137</b></li> </ul>	

**128H**  Hex Bits  
Puntas Hexagonales

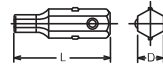

**128T**  TORX® Bits  
Puntas TORX®

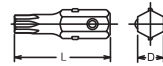

**101A**  Adaptor  
Adaptador

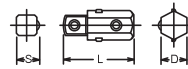

**1202**  Bit Set  
Juego de Puntas



**2254M**  Bit Set  
Juego de Puntas



HAND MANUALES  
Z-SERIES  
TITANIUM DE TITANIO  
ACCESSORIES ACCESORIOS  
SCREWDRIVERS DESTORNILLADORES  
IMPACT DE IMPACTO  
SLEEVE-DRIVE INDUSTRIAL INDUSTRIALES  
PROTECTOR PROTECTORES  
AUTOMOTIVE  
CONSTRUCTION CONSTRUCCION  
RENEWAL KITS JUEGOS DE PIEZAS REEMPLISTO

# ATTACK DRIVER®

HAND  
MANUALES

**3112N** Attack Driver  
Destornillador de Impacto



	□	L (mm)	⚖ (g)	⊞ (pce.)
3112N		159	730	1
3112G	3/8"	159	810	1

\* Renewal Kits → **3112RK** → P289

Z-SERIES

**3112G** Attack Driver  
Destornillador de Impacto



	□	L (mm)	⚖ (g)	⊞ (pce.)
4112N	1/2"	163	730	1
4112G		163	810	1

\* Renewal Kits → **4112RK** → P289

TITANIUM  
DE TITANIO

ACCESSORIES  
ACCESORIOS

**4112N** Attack Driver  
Destornillador de Impacto



	□	L (mm)	⚖ (g)	⊞ (pce.)
6112	3/4"	190	1900	1

\* Renewal Kits → **6112RK** → P289

SCREWDRIVERS  
DESTORNILLADORES

IMPACT  
DE IMPACTO

SLEEVE-DRIVE

**4112G** Attack Driver  
Destornillador de Impacto



INDUSTRIAL  
INDUSTRIALES

PROTECTOR  
PROTECTORES

**6112** Attack Driver  
Destornillador de Impacto



AUTOMOTIVE

RENEWAL KITS  
JUEGOS DE PIEZAS REPUESTO





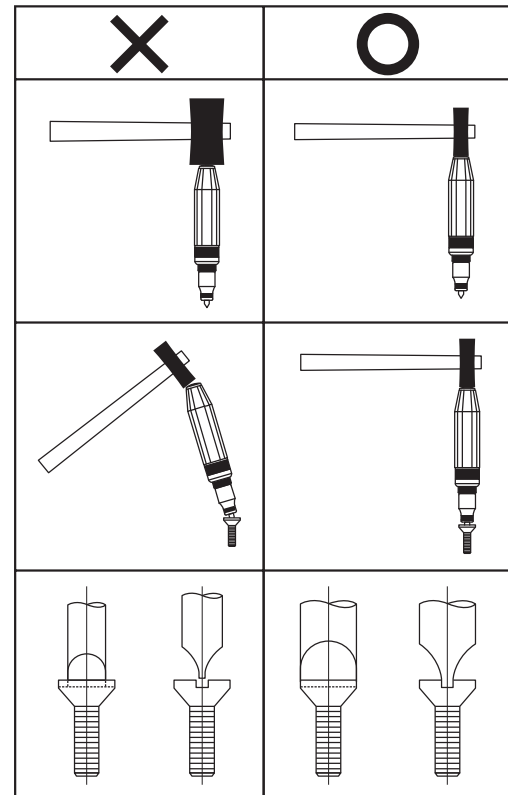

Black finished head prevents peeling off the chrome plate by striking the head.





**AN318A** 6 Pieces Set/Δ=1,070g

METAL CASE:W190xH59xT45mm

Bits		Accessories	
 <b>100P.32</b> Phillips Bits 2, 3		<b>3112N</b>	
 <b>100S.32</b> Slotted Bits 9, 11		<b>3138</b>	





**AN112A** 6 Pieces Set/Δ=1,070g

METAL CASE:W190xH59xT45mm

Bits		Accessories	
 <b>100P.32</b> Phillips Bits 2, 3		<b>4112N</b>	
 <b>100S.32</b> Slotted Bits 9, 11		<b>4138</b>	





**AG318A** 6 Pieces Set/Δ=1,150g

METAL CASE:W220xH82xT60mm

Bits		Accessories	
 <b>100P.32</b> Phillips Bits 2, 3		<b>3112G</b>	
 <b>100S.32</b> Slotted Bits 9, 11		<b>3138</b>	





**AG112A** 6 Pieces Set/Δ=1,150g

METAL CASE:W220xH82xT60mm

Bits		Accessories	
 <b>100P.32</b> Phillips Bits 2, 3		<b>4112G</b>	
 <b>100S.32</b> Slotted Bits 9, 11		<b>4138</b>	









**AN112C** 8 Pieces Set/Δ=1,350g

METAL CASE:W220xH82xT60mm

Bits		Accessories	
 <b>100P.80</b> Phillips Bits 1, 2, 3		<b>4112N</b>	
 <b>100S.80</b> Slotted Bits 7, 9, 12		<b>4138</b>	







**AG112F** 25 Pieces Set/Δ=1,530g

METAL CASE:W220xH82xT60mm

Bits		Accessories	
 <b>100P.32</b> Phillips Bits 2, 3		<b>4112G</b>	
 <b>100P.32</b> PZ Bits P22, PZ3		<b>4138</b>	
 <b>100S.32</b> Slotted Bits 9, 11			
 <b>100H.32</b> Hex Bits 4, 5, 6, 7, 8, 10			
 <b>100T.32</b> TORX® Bits T25, T27, T30, T40, T45, T50			
 <b>100X.32</b> XZN Bits M5, M6, M8, M10, M12			

**AG112H** 18 Pieces Set/Δ=1,480g

METAL CASE:W220xH82xT60mm

Bits		Accessories	
 <b>100P.32</b> Phillips Bits 2, 3, 4		<b>4112G</b>	
 <b>100S.32</b> Slotted Bits 8, 9, 10, 12, 14		<b>4138</b>	
 <b>100H.32</b> Hex Bits 5, 6, 8, 10			
 <b>100T.32</b> TORX® Bits T30, T40, T45, T50			

**AN318A** Attack Driver Set  
**AN112A** Juego de Destornilladores de Impacto



**AG318A** Attack Driver Set  
**AG112A** Juego de Destornilladores de Impacto



**AN112C** Attack Driver Set  
Juego de Destornilladores de Impacto



**AG112F** Attack Driver Set  
Juego de Destornilladores de Impacto



**AG112H** Attack Driver Set  
Juego de Destornilladores de Impacto



HAND  
MANUALES  
Z-SERIES  
TITANIUM  
DE TITANIO  
ACCESSORIES  
ACCESORIOS  
SCREWDRIVERS  
DESTORNILLADORES  
DE IMPACTO  
SLEEVE-DRIVE  
INDUSTRIAL  
INDUSTRIALES  
PROTECTOR  
PROTECTORES  
AUTOMOTIVE  
CONSTRUCTION  
RENEWAL KITS  
JUEGOS DE PIEZAS REPUESTO

HAND MANUALES  
Z-SERIES  
TITANIUM DE TITANIO  
ACCESSORIES ACCESORIOS  
SCREWDRIVERS DESTORNILLADORES  
IMPACT DE IMPACTO  
SLEEVE-DRIVE  
INDUSTRIAL INDUSTRIALES  
PROTECTOR PROTECTORES  
AUTOMOTIVE  
CONSTRUCTION CONSTRUCCIÓN  
RENEWAL KITS JUEGOS DE PIEZAS REPUESTO

**108P-25 · -32 · -50**  Phillips Bits  
Puntas Phillips

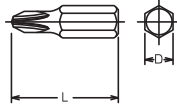

108P.25 (PH)	D (mm)	L (mm)	(g)	(pcs.)
1	6.35	25	5	10
2	6.35	25	5	10
3	6.35	25	6	10

108P.32 (PH)	D (mm)	L (mm)	(g)	(pcs.)
1	6.35	32	7	10
2	6.35	32	7	10
3	6.35	32	8	10

108P.50 (PH)	D (mm)	L (mm)	(g)	(pcs.)
1	6.35	50	10	10
2	6.35	50	11	10
3	6.35	50	11	10

**108S-25 · -39**  Bits for Slotted head  
Puntas Rectas/Planas

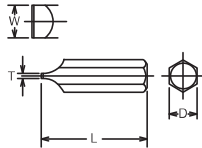

108S.25	TxW (mm)	D (mm)	L (mm)	(g)	(pcs.)
3	0.5x3	6.35	25	3	10
4	0.6x4	6.35	25	3	10
4.5	0.6x4.5	6.35	25	4	10
5	0.8x5	6.35	25	5	10
5.5	0.8x5.5	6.35	25	5	10
6	1.0x6	6.35	25	5	10
8	1.2x8	6.35	25	6	10

108S.39	TxW (mm)	D (mm)	L (mm)	(g)	(pcs.)
3	0.5x3	6.35	39	6	10
4	0.6x4	6.35	39	6	10
4.5	0.6x4.5	6.35	39	6	10
5	0.8x5	6.35	39	7	10
5.5	0.8x5.5	6.35	39	8	10
6	1.0x6	6.35	39	9	10
8	1.2x8	6.35	39	12	10

**108H-25**  Hex Bits  
Puntas Hexagonales

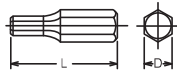

108H.25 (mm)	D (mm)	L (mm)	(g)	(pcs.)
3	6.35	25	4	10
4	6.35	25	5	10
5	6.35	25	5	10
6	6.35	25	6	10
7	6.35	25	7	10
8	6.35	25	8	10
10	6.35	25	11	10

108H.25 (inch)	D (mm)	L (mm)	(g)	(pcs.)
1/8	6.35	25	4	10
9/64	6.35	25	5	10
3/16	6.35	25	5	10
7/32	6.35	25	6	10
1/4	6.35	25	7	10

**108T-25 (T)**  TORX® Bits  
Puntas TORX®

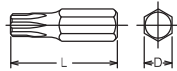

108T.25 (T)	D (mm)	L (mm)	(g)	(pcs.)
T10	6.35	25	4	10
T15	6.35	25	4	10
T20	6.35	25	5	10
T25	6.35	25	6	10
T27	6.35	25	6	10
T30	6.35	25	6	10
T40	6.35	25	6	10

**108T-25 (TH)**  Tamper-Resistant TORX® Bits  
Punta TORX®, indeformable 

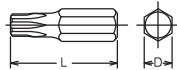

108T.25 (TH)	D (mm)	L (mm)	(g)	(pcs.)
T10H	6.35	25	4	10
T15H	6.35	25	4	10
T20H	6.35	25	5	10
T25H	6.35	25	6	10
T27H	6.35	25	6	10
T30H	6.35	25	6	10
T40H	6.35	25	6	10

 Tamper Resistant TORX® Bits have less strength due to special design. Make sure to use it correctly.

HAND MANUALES  
Z-SERIES  
TITANIUM DE TITANIO  
ACCESSORIES ACCESORIOS  
SCREWDRIVERS DESTORNILLADORES  
IMPACT DE IMPACTO  
SLEEVE-DRIVE  
INDUSTRIAL INDUSTRIALES  
PROTECTOR PROTECTORES  
AUTOMOTIVE  
CONSTRUCTION CONSTRUCCION  
RENEWAL KITS JUEGOS DE PIEZAS REPUESTO

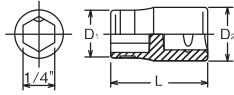
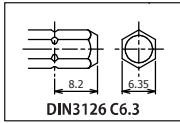

	□	D <sub>1</sub> (mm)	D <sub>2</sub> (mm)	L (mm)	⚖️ (g)	◇ (pcs.)
2137	1/4"	12	12	22.5	13	10
3137	3/8"	13	16.5	30	30	10
4137	1/2"	13	22	38	53	10

**2137** ○ Bit Holder Porta-punta



**3137** ○ Bit Holder Porta-punta



**4137** ○ Bit Holder Porta-punta

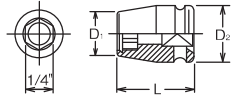
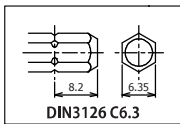

	□	D <sub>1</sub> (mm)	D <sub>2</sub> (mm)	L (mm)	⚖️ (g)	◇ (pcs.)	⚡
12139-1/4	1/4"	11	13	26	15	10	*1
13139-1/4	3/8"	11	19	30	32	10	*2
14139-1/4	1/2"	11	25	38	62	10	*3

**12139** ○ Impact Bit Holder Porta-punta de Impacto



**13139** ○ Impact Bit Holder Porta-punta de Impacto



**14139** ○ Impact Bit Holder Porta-punta de Impacto



\*1 Pin/O-Ring=1200A/B

\*2 C-Ring=1301C, Pin/O-Ring=1301A/B

\*3 C-Ring=1401C, Pin/O-Ring=1401A/B

→ P238-239

Lock & Quick Release

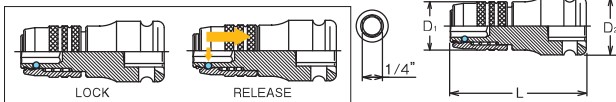

**13142-D6.3** ○ Impact Bit Holder for 1/4" (6.3) Bits Porta-punta de Impacto para Puntas 1/4" (6.3)

**14142-D6.3** ○

	□	D <sub>1</sub> (mm)	D <sub>2</sub> (mm)	L (mm)	⚖️ (g)	◇ (pcs.)	⚡
13142-D6.3	3/8"	16	19	45	60	10	*1
14142-D6.3	1/2"	16	25	55	97	10	*2

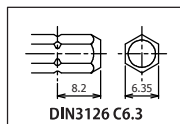

\*1 C-Ring=1301C, Pin/O-Ring=1301A/B

\*2 C-Ring=1401C, Pin/O-Ring=1401A/B

→ P238-239

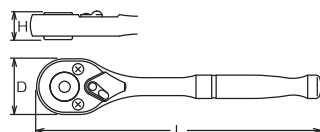
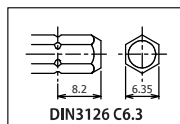

**2749P-1/4HF** ○ Reversible Ratchet, for Bits 1/4" Llave de Carraca Reversible, para Puntas 1/4"



**2774P-1/4HF** ○ Flexible Ratchet, Reversible, for Bits 1/4" Llave de Carraca Reversible, para Puntas 1/4"



	D (mm)	H (mm)	L (mm)	⚖️ (g)	◇ (pcs.)
2749P-1/4HF	25	12	125	96	10
2774P-1/4HF	25	12	165	133	2



HAND  
MANUALES

Z-SERIES

TITANIUM  
DE TITANIO

ACCESSORIES  
ACCESORIOS

SCREWDRIVERS  
DESTORNILLADORES

IMPACT  
DE IMPACTO

SLEEVE-DRIVE

INDUSTRIAL  
INDUSTRIALES

PROTECTOR  
PROTECTORES

AUTOMOTIVE

RENEWAL KITS  
JUEGOS DE PIEZAS REPUESTO  
CONSTRUCCIÓN

## 100P-32 · -80 · -125

Phillips Bits  
Puntas Phillips



100P.32 (PH)	D (mm)	L (mm)	(g)	(pcs.)
1	8	32	11	10
2	8	32	11	10
3	8	32	12	10
4	8	32	12	10

100P.80 (PH)	D (mm)	L (mm)	(g)	(pcs.)
1	8	80	30	10
2	8	80	30	10
3	8	80	31	10
4	8	80	32	10

100P.125 (PH)	D (mm)	L (mm)	(g)	(pcs.)
2	8	125	48	10
3	8	125	49	10

## 100P-32 (PZ)

PZ Bits  
Puntas PZ



100P.32 (PZ)	D (mm)	L (mm)	(g)	(pcs.)
PZ2	8	32	10	10
PZ3	8	32	11	10

## 100S-32 · -80

Bits for Slotted Head  
Puntas Rectas/Planas

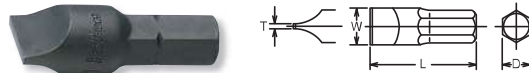

100S.32	TxW (mm)	D (mm)	L (mm)	(g)	(pcs.)
6	1 x 6	8	32	10	10
7	1 x 7	8	32	11	10
8	1.2x 8	8	32	12	10
9	1.6x 9	8	32	12	10
10	1.6x10	8	32	13	10
11	1.6x11	8	32	15	10
12	2 x12	8	32	18	10
14	2 x14	8	32	21	10

100S.80	TxW (mm)	D (mm)	L (mm)	(g)	(pcs.)
6	1 x 6	8	80	29	10
7	1 x 7	8	80	30	10
8	1.2x 8	8	80	31	10
9	1.6x 9	8	80	32	10
10	1.6x10	8	80	33	10
11	1.6x11	8	80	33	10
12	2 x12	8	80	34	10
14	2 x14	8	80	37	10

## 100H-32

Hex Bits  
Puntas Hexagonales



100H.32 (mm)	D (mm)	L (mm)	(g)	(pcs.)
3	8	32	11	10
4	8	32	11	10
5	8	32	12	10
6	8	32	12	10
7	8	32	13	10
8	8	32	13	10
10	8	32	16	10
12	8	32	23	10
14	8	32	29	10

## 100X-32 (XZN)

XZN Bits  
Puntas XZN



100X.32 (XZN)	D (mm)	L (mm)	(g)	(pcs.)
M 5	8	32	10	10
M 6	8	32	11	10
M 8	8	32	12	10
M10	8	32	16	10
M12	8	32	19	10

## 100T-32 (T)

TORX® Bits  
Puntas TORX®



100T.32 (T)	D (mm)	L (mm)	(g)	(pcs.)
T10	8	32	9	10
T15	8	32	9	10
T20	8	32	9	10
T25	8	32	10	10
T27	8	32	10	10
T30	8	32	11	10
T40	8	32	12	10
T45	8	32	12	10
T50	8	32	12	10
T55	8	32	12	10

## 100T-32 (TH)

Tamper-Resistant TORX® Bits  
Punta TORX®, indeformable

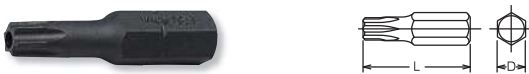

100T.32 (TH)	D (mm)	L (mm)	(g)	(pcs.)
T10H	8	32	9	10
T15H	8	32	9	10
T20H	8	32	9	10
T25H	8	32	10	10
T27H	8	32	10	10
T30H	8	32	11	10
T40H	8	32	12	10
T45H	8	32	12	10
T50H	8	32	12	10
T55H	8	32	12	10

⚠ Tamper Resistant TORX® Bits have less strength due to special design. Make sure to use it correctly.

HAND  
MANUALES

Z-SERIES

TITANIUM  
DE TITANIO

ACCESSORIES  
ACCESORIOS

SCREWDRIVERS  
DESTORNILLADORES

IMPACT  
DE IMPACTO

SLEEVE-DRIVE

INDUSTRIAL  
INDUSTRIALES

PROTECTOR  
PROTECTORES

AUTOMOTIVE

CONSTRUCTION  
CONSTRUCCION

RENEWAL KITS  
JUEGOS DE PIEZAS REEMPLAZO

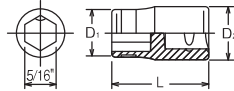
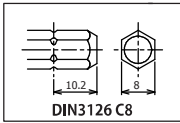

	□	D <sub>1</sub> (mm)	D <sub>2</sub> (mm)	L (mm)	⚖️ (g)	◇ (pcs.)
2138	1/4"	16	16	26	32	10
3138	3/8"	16	18	38	55	10
4138	1/2"	16	22	38	62	10

**2138** ○ Bit Holder  
Porta-punta



**3138** ○ Bit Holder  
Porta-punta



**4138** ○ Bit Holder  
Porta-punta

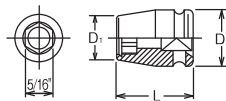
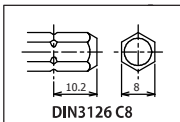

	□	D <sub>1</sub> (mm)	D <sub>2</sub> (mm)	L (mm)	⚖️ (g)	◇ (pcs.)	⊖
12140-5/16	1/4"	14	13	26	15	10	*1
13140-5/16	3/8"	14	19	30	32	10	*2
14140-5/16	1/2"	14	25	38	62	10	*3

\*1 Pin/O-Ring=1200A/B

\*2 C-Ring=1301C,Pin/O-Ring=1301A/B

\*3 C-Ring=1401C,Pin/O-Ring=1401A/B

→ P238-239

**12140** ○ Impact Bit Holder  
Porta-punta de Impacto



**13140** ○ Impact Bit Holder  
Porta-punta de Impacto



**14140** ○ Impact Bit Holder  
Porta-punta de Impacto

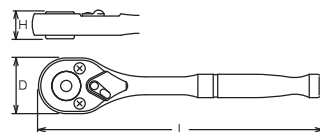
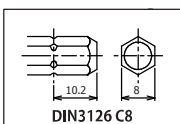

	D (mm)	H (mm)	L (mm)	⚖️ (g)	◇ (pcs.)
2749P-5/16HF	25	14	125	96	10
2774P-5/16HF	25	14	165	133	2

**2749P-5/16HF** ○ Reversible Ratchet, for Bits 5/16"  
Llave de Carraca Reversible, para Puntas 5/16"



**2774P-5/16HF** ○ Flexible Ratchet, reversible, for Bits 5/16"  
Llave de Carraca Reversible, para Puntas 5/16"



# Double ended Bits 5/16"

HAND MANUALES  
 Z-SERIES  
 TITANIUM DE TITANIO  
 ACCESSORIES ACCESORIOS  
 SCREWDRIVERS DESTORNILLADORES  
 IMPACT DE IMPACTO  
 SLEEVE-DRIVE  
 INDUSTRIAL INDUSTRIALES  
 PROTECTOR PROTECTORES  
 AUTOMOTIVE  
 RENEWAL KITS CONSTRUCTION JUEGOS DE PIEZAS REPUESTO CONSTRUCCIÓN

## 131P-80 + Phillips Bits Puntas Phillips



131P.80	<span style="color: green;">+</span>	D (mm)	L (mm)	(g)	(pcs.)
1	No.1xNo.2	8	80	28	10
2	No.2xNo.3	8	80	29	10
3	No.3xNo.3	8	80	29	10

## 131S-80 - Bits for Slotted heads Puntas Rectas/Planas

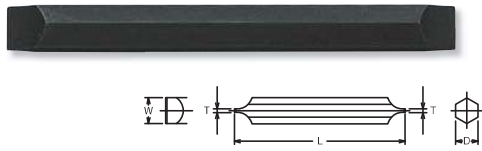

131S.80	TxW (mm)	D (mm)	L (mm)	(g)	(pcs.)
6	1.0x6	8	80	29	10
7	1.0x7	8	80	29	10
8	1.2x8	8	80	30	10
9	1.6x9	8	80	31	10

## 131PS-80 + - Double Ended Bits Puntas

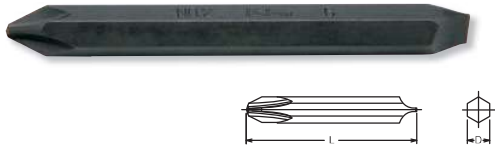

131PS.80	<span style="color: green;">+</span> <span style="color: green;">-</span>	D (mm)	L (mm)	(g)	(pcs.)
2	No.2xNo.6	8	80	29	10
3	No.3xNo.8	8	80	29	10

## 131T-80 + TORX® Bits Puntas TORX®

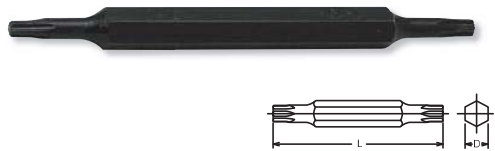

131T.80 (T)	D (mm)	L (mm)	(g)	(pcs.)
T10xT15	8	80	27	10
T20xT25	8	80	27	10
T27xT30	8	80	28	10

## 3141 ○ Bit Holder, Extra Deep for 131P-80, 131S-80, 131T-80 Porta-punta, extra-largo para 131P-80, 131S-80, 131T-80



## 4141 ○ Bit Holder, Extra Deep for 131P-80, 131S-80, 131T-80 Porta-punta, extra-largo para 131P-80, 131S-80, 131T-80

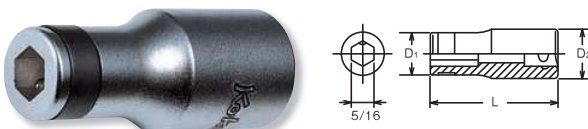

	<span style="color: green;">□</span>	D <sub>1</sub> (mm)	D <sub>2</sub> (mm)	L (mm)	(g)	(pcs.)
3141	<span style="border: 1px solid black; padding: 2px;">3/8"</span>	16	18	48	60	10
4141	<span style="border: 1px solid black; padding: 2px;">1/2"</span>	16	22	52	70	10

123PT (PH)	D (mm)	L (mm)	(g)	(pcs.)
2	6.35	75	18	10
2	6.35	100	24	10

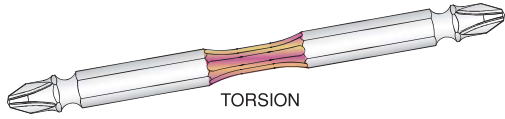

## 123PT-75 · -100 + Double Ended Torsion Bits Puntas Phillips, simétricas, Torsion

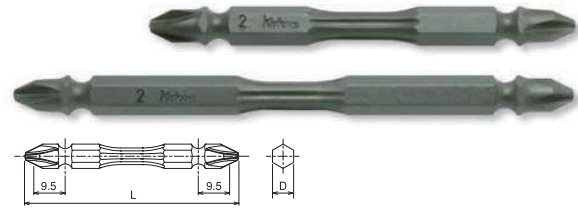

123PN.75 123PG.75 (PH)	D (mm)	L (mm)	(g)	(pcs.)
1	6.35	75	16	10
2	6.35	75	16	10
3	6.35	75	17	10

123PN.100 123PG.100 (PH)	D (mm)	L (mm)	(g)	(pcs.)
1	6.35	100	23	10
2	6.35	100	23	10
3	6.35	100	24	10

## 123PN-75 · -100 + Double Ended Bits Puntas Phillips, simétricas

## 123PG-75 · -100 + Magnetic type

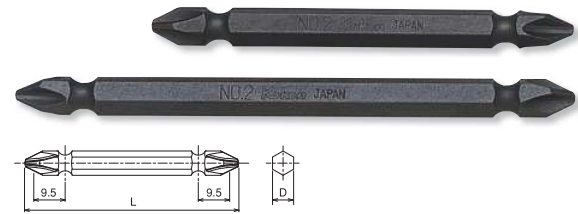

165LM.45 (mm)	D (mm)	ℓ (mm)	L (mm)	(g)	(pcs.)
8	13.5	3.5	45	55	10
10	16	4.2	45	58	10
12	18.5	5.6	45	65	10
14	21	6.4	45	70	10

Slide the socket by pulling holder, and pull back the socket to lock on the bit groove.  
Ring magnet holds a bolt or nut for easy work.

## 165LM ○ Slide Socket with Magnet



Nut Setter



Phillips Bit

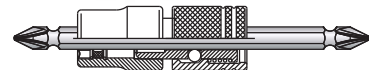

HAND  
MANUALES  
Z-SERIES  
TITANIUM  
DE TITANIO  
ACCESSORIES  
ACCESORIOS  
SCREWDRIVERS  
DESTORNILLADORES  
IMPACT  
DE IMPACTO  
SLEEVE-DRIVE  
INDUSTRIAL  
INDUSTRIALES  
PROTECTOR  
PROTECTORES  
AUTOMOTIVE  
CONSTRUCTION  
CONSTRUCCION  
RENEWAL KITS  
JUEGOS DE HERRAS RENOVISTO

HAND  
MANUALES

Z-SERIES

TITANIUM  
DE TITANIO

ACCESSORIES  
ACCESORIOS

SCREWDRIVERS  
DESTORNILLADORES

IMPACT  
DE IMPACTO

SLEEVE DRIVE

INDUSTRIAL  
INDUSTRIALES

PROTECTOR  
PROTECTORES

AUTOMOTIVE

CONSTRUCTION  
CONSTRUCCIÓN

RENEWAL KITS  
JUEGOS DE PIEZAS REPUESTO

**121P-50 · -70 · -100 · -150**  Phillips Bits  
Puntas Phillips

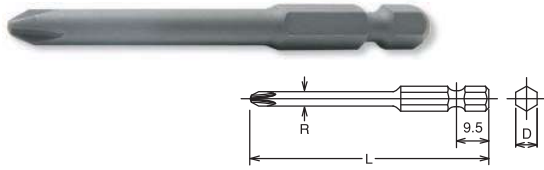

121P.50 (PH)	D (mm)	R (mm)	L (mm)	(g)	(pcs.)
1	6.35	4.5	50	12	10
2	6.35	5.5	50	12	10
3	6.35	-	50	13	10

121P.70 (PH)	D (mm)	R (mm)	L (mm)	(g)	(pcs.)
1	6.35	4.5	70	15	10
2	6.35	5.5	70	15	10
3	6.35	-	70	16	10

121P.100 (PH)	D (mm)	R (mm)	L (mm)	(g)	(pcs.)
1	6.35	4.5	100	23	10
2	6.35	5.5	100	23	10
3	6.35	-	100	24	10

121P.150 (PH)	D (mm)	R (mm)	L (mm)	(g)	(pcs.)
1	6.35	4.5	150	30	10
2	6.35	5.5	150	35	10
3	6.35	-	150	36	10

**121H-50 · -70 · -100 · -150**  Hex Bits  
Puntas Hexagonales

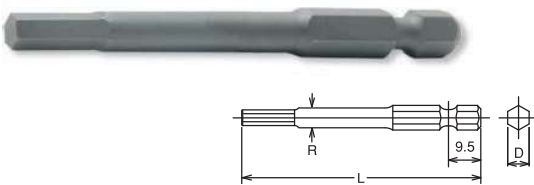

121H.50 (mm)	D (mm)	R (mm)	L (mm)	(g)	(pcs.)
<b>New</b> 2.5	6.35	3.0	50	12	10
3	6.35	3.5	50	12	10
4	6.35	4.5	50	12	10
5	6.35	5.6	50	13	10
6	6.35	-	50	14	10

121H.70 (mm)	D (mm)	R (mm)	L (mm)	(g)	(pcs.)
<b>New</b> 2.5	6.35	4.0	70	15	10
3	6.35	4.0	70	15	10
4	6.35	4.5	70	15	10
5	6.35	5.6	70	16	10
6	6.35	-	70	18	10

121H.100 (mm)	D (mm)	R (mm)	L (mm)	(g)	(pcs.)
<b>New</b> 2.5	6.35	4.0	100	23	10
3	6.35	4.0	100	23	10
4	6.35	4.5	100	23	10
5	6.35	5.6	100	24	10
6	6.35	-	100	26	10

121H.150 (mm)	D (mm)	R (mm)	L (mm)	(g)	(pcs.)
3	6.35	4.5	150	37	10
4	6.35	5.0	150	37	10
5	6.35	6.0	150	38	10
6	6.35	-	150	39	10

**121T-50 · -70 · -100 · -150 (T)**  TORX® Bits  
Puntas TORX®

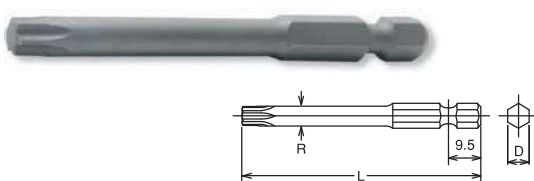

121T.50 (T)	D (mm)	R (mm)	L (mm)	(g)	(pcs.)
<b>New</b> T10	6.35	3.0	50	12	10
T15	6.35	3.5	50	12	10
T20	6.35	4.1	50	12	10
T25	6.35	4.6	50	12	10
T27	6.35	5.2	50	13	10
T30	6.35	5.7	50	13	10
T40	6.35	-	50	14	10

121T.70 (T)	D (mm)	R (mm)	L (mm)	(g)	(pcs.)
<b>New</b> T10	6.35	3.5	70	16	10
T15	6.35	3.5	70	16	10
T20	6.35	4.1	70	16	10
T25	6.35	4.6	70	16	10
T27	6.35	5.2	70	17	10
T30	6.35	5.7	70	17	10
T40	6.35	-	70	18	10

121T.100 (T)	D (mm)	R (mm)	L (mm)	(g)	(pcs.)
<b>New</b> T10	6.35	3.5	100	24	10
T15	6.35	4.0	100	24	10
T20	6.35	4.1	100	24	10
T25	6.35	4.6	100	24	10
T27	6.35	5.2	100	24	10
T30	6.35	5.7	100	25	10
T40	6.35	-	100	26	10

121T.150 (T)	D (mm)	R (mm)	L (mm)	(g)	(pcs.)
T15	6.35	4.0	150	37	10
T20	6.35	4.5	150	37	10
T25	6.35	5.0	150	37	10
T27	6.35	5.6	150	37	10
T30	6.35	6.0	150	38	10
T40	6.35	-	150	39	10

121T.70 (TH)	D (mm)	R (mm)	L (mm)	(g)	(pcs.)
T20H	6.35	4.1	70	16	10
T25H	6.35	4.6	70	16	10
T27H	6.35	5.2	70	17	10
T30H	6.35	5.7	70	17	10
T40H	6.35	-	70	18	10

121T.100 (TH)	D (mm)	R (mm)	L (mm)	(g)	(pcs.)
T20H	6.35	4.1	100	24	10
T25H	6.35	4.6	100	24	10
T27H	6.35	5.2	100	24	10
T30H	6.35	5.7	100	25	10
T40H	6.35	-	100	26	10

Tamper Resistant TORX® Bits have less strength due to special design. Make sure to use it correctly.

121T.50 (IP)	D (mm)	R (mm)	L (mm)	(g)	(pcs.)
<b>New</b> 20IP	6.35	4.1	50	12	10
<b>New</b> 25IP	6.35	4.6	50	12	10
<b>New</b> 27IP	6.35	5.2	50	13	10
<b>New</b> 30IP	6.35	5.7	50	13	10
<b>New</b> 40IP	6.35	-	50	14	10

121T.70 (IP)	D (mm)	R (mm)	L (mm)	(g)	(pcs.)
<b>New</b> 20IP	6.35	4.1	70	16	10
<b>New</b> 25IP	6.35	4.6	70	16	10
<b>New</b> 27IP	6.35	5.2	70	17	10
<b>New</b> 30IP	6.35	5.7	70	17	10
<b>New</b> 40IP	6.35	-	70	18	10

	□	D <sub>1</sub> (mm)	D <sub>2</sub> (mm)	L (mm)	(g)	(pcs.)	⊕
12137E	1/4"	12	13	36	22	10	*1
13137H	3/8"	13	19	42	77	10	*2
13137E	3/8"	12	19	40	40	10	*2
14137E	1/2"	12	25	48	70	10	*3

\*1 Pin/O-Ring=1200A/B

\*2 C-Ring=1301C, Pin/O-Ring=1301A/B → P238-239

\*3 C-Ring=1401C, Pin/O-Ring=1401A/B

### Lock & Quick Release

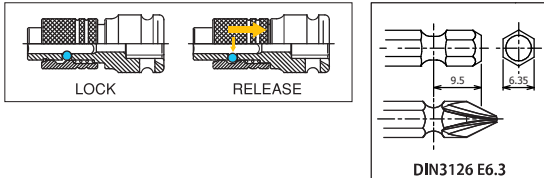

	□	D <sub>1</sub> (mm)	D <sub>2</sub> (mm)	L (mm)	(g)	(pcs.)	⊕
12142-F6.3	1/4"	16.5	13	36	22	10	*1
13142-F6.3	3/8"	16.5	19	45	60	10	*2
14142-F6.3	1/2"	16.5	25	55	100	10	*3

\*1 Pin/O-Ring=1200A/B

\*2 C-Ring=1301C, Pin/O-Ring=1301A/B → P238-239

\*3 C-Ring=1401C, Pin/O-Ring=1401A/B

## 121T-70 · -100 (TH)

Tamper-Resistant TORX® Bits  
Punta TORX®, indeformable

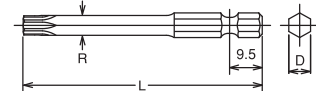

## 121T-50 · -70 (IP)

TORX Plus® Bits  
Puntas TORX Plus®

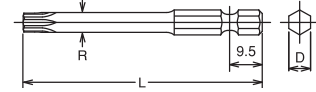

## 13137H

Impact Bit Holder for 1/4"(6.3) Bits  
Porta-punta de impacto para Puntas 1/4"(6.3)

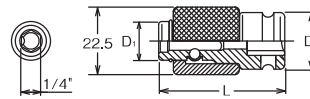

## 12137E

Impact Bit Holder for 1/4"(6.3) Bits  
Porta-punta de impacto para Puntas 1/4"(6.3)

## 13137E

## 14137E

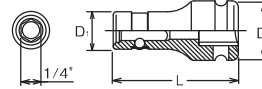

## 12142-F6.3

Impact Bit Holder for 1/4"(6.3) Bits  
Porta-punta de impacto para Puntas 1/4"(6.3)

## 13142-F6.3

## 14142-F6.3

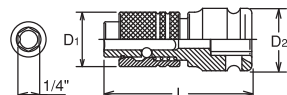

HAND  
MANUALES

Z-SERIES

TITANIUM  
DE TITANIO

ACCESSORIES  
ACCESORIOS

SCREWDRIVERS  
DESTORNILLADORES

IMPACT  
DE IMPACTO

SLEEVE-DRIVE

INDUSTRIAL  
INDUSTRIALES

PROTECTOR  
PROTECTORES

AUTOMOTIVE

RENEWAL KITS  
JUEGOS DE PIEZAS REPUESTO  
CONSTRUCCIÓN

### 183H-35 · -75

Bits for Inhex Screws  
Puntas para Tornillos Inhex

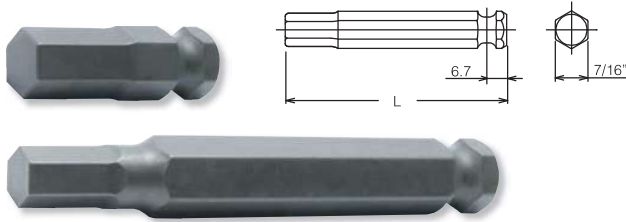

	183H.35 (mm)	L (mm)	 (g)	 (pcs.)
New	3	35	15	10
New	4	35	15	10
New	5	35	15	10
New	6	35	18	10
New	8	35	20	10
New	10	35	26	10
New	12	35	30	10

	183H.75 (mm)	L (mm)	 (g)	 (pcs.)
New	3	75	48	10
New	4	75	48	10
New	5	75	49	10
New	6	75	51	10
New	8	75	52	10
New	10	75	57	10
New	12	75	65	10

### 183T-35 · -75(T)

TORX® Bits  
Puntas TORX®

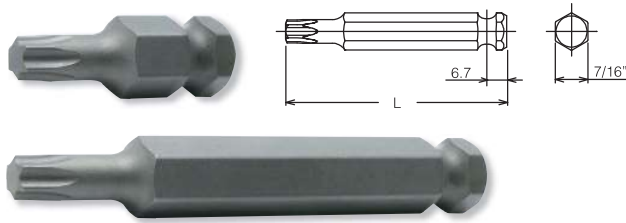

	183T.35 (T)	L (mm)	 (g)	 (pcs.)
New	T30	35	18	10
New	T40	35	20	10
New	T45	35	22	10
New	T50	35	26	10
New	T55	35	30	10
New	T60	35	38	10

	183T.75 (T)	L (mm)	 (g)	 (pcs.)
New	T30	75	48	10
New	T40	75	49	10
New	T45	75	51	10
New	T50	75	52	10
New	T55	75	57	10
New	T60	75	67	10

### 183X-35 · -75(XZN)

XZN Bits  
Puntas XZN

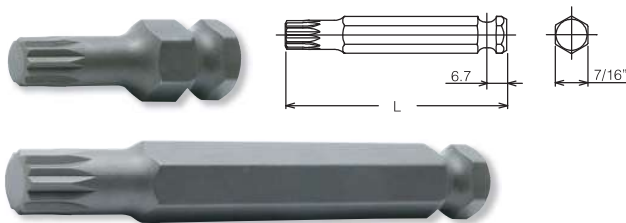

	183X.35 (XZN)	L (mm)	 (g)	 (pcs.)
New	M 5	35	18	10
New	M 6	35	20	10
New	M 8	35	22	10
New	M10	35	26	10
New	M12	35	30	10
New	M14	35	38	10

	183X.75 (XZN)	L (mm)	 (g)	 (pcs.)
New	M 5	75	48	10
New	M 6	75	49	10
New	M 8	75	51	10
New	M10	75	52	10
New	M12	75	57	10
New	M14	75	67	10

### 13134

Bit Holder  
Porta Punta

### 14134

### 16134



		D (mm)	L (mm)	 (g)	 (pcs.)	
New	13134	22	32	70	10	*1
New	14134	25	38	90	10	*2
New	16134	44	52	200	2	*3

\*1 C-Ring=1302C, Pin/O-Ring=1302A/B

\*2 C-Ring=1401C, Pin/O-Ring=1401A/B

\*3 C-Ring=1600C, Pin/O-Ring=1601A/B

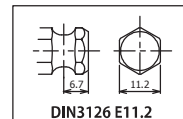

### 13142-F11.2

Bit Holder  
Porta Punta

### 14142-F11.2



		D <sub>1</sub> (mm)	D <sub>2</sub> (mm)	L (mm)	 (g)	 (pcs.)	
New	13142-F11.2	18.9	22	46	116	10	*1
New	14142-F11.2	18.9	25	46	207	10	*2

\*1 C-Ring=1302C, Pin/O-Ring=1302A/B

\*2 C-Ring=1401C, Pin/O-Ring=1401A/B

## 113-50 Nut Setters Vasos para apretar tuercas Hexagonales

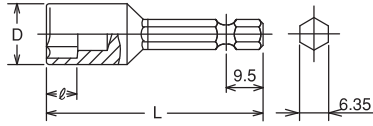

113.50 (mm)	D (mm)	ℓ (mm)	L (mm)	(g)	(pcs.)
5.5	9	4	50	15	10
6	10	5	50	17	10
7	11	5	50	19	10
8	12	6	50	20	10
10	14.2	7	50	31	10
12	17	8	50	39	10
13	18	8	50	42	10
14	19	9	50	46	10

113.50 (inch)	D (mm)	ℓ (mm)	L (mm)	(g)	(pcs.)
1/4	10	5	50	17	10
5/16	12	6	50	20	10
3/8	14.2	7	50	31	10
1/2	18	8	50	42	10

## 113-75 · -100 · -150 · -200 · -250 Nut Setters Vasos para apretar tuercas Hexagonales

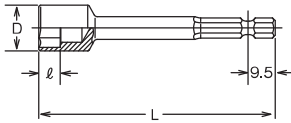

113.75 (mm)	D (mm)	ℓ (mm)	L (mm)	(g)	(pcs.)
7	11.5	5	75	31	10
8	12.7	6	75	32	10
10	14.5	7	75	35	10
12	17	8	75	42	10
13	18	8	75	41	10
14	19	9	75	43	10

113.100 (mm)	D (mm)	ℓ (mm)	L (mm)	(g)	(pcs.)
7	11.5	5	100	40	10
8	12.7	6	100	41	10
10	14.5	7	100	45	10
12	17	8	100	52	10
13	18	8	100	51	10
14	19	9	100	53	10

113.150 (mm)	D (mm)	ℓ (mm)	L (mm)	(g)	(pcs.)
7	11.5	5	150	59	10
8	12.7	6	150	60	10
10	14.5	7	150	64	10
12	17	8	150	70	10
13	18	8	150	76	10
14	19	9	150	78	10

113.200 (mm)	D (mm)	ℓ (mm)	L (mm)	(g)	(pcs.)
7	11.5	5	200	78	10
8	12.7	6	200	79	10
10	14.5	7	200	83	10
12	17	8	200	91	10
13	18	8	200	93	10
14	19	9	200	95	10

113.250 (mm)	D (mm)	ℓ (mm)	L (mm)	(g)	(pcs.)
7	11.5	5	250	99	10
8	12.7	6	250	100	10
10	14.5	7	250	105	10
12	17	8	250	113	10
13	18	8	250	114	10
14	19	9	250	119	10

113.50 (E)	D (mm)	ℓ (mm)	L (mm)	(g)	(pcs.)
E 4	6.1	4.5	50	12	10
E 5	7.5	4.5	50	15	10
E 6	8.3	5.0	50	17	10
E 7	8.8	5.8	50	18	10
E 8	10.1	6.6	50	19	10
E10	12	7.4	50	20	10

## 113-50 (E) Nut Setters, TORX® Vasos para apretar tuercas, TORX®

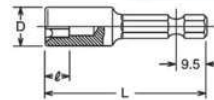

## 113-50 (2B) Nut Setters Nut Grip® Vasos para apretar tuercas con 2 bolas

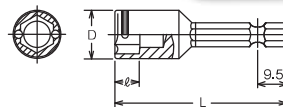

113.50 (mm)	D (mm)	ℓ (mm)	L (mm)	(g)	(pcs.)
7(2B)	11	5	50	20	10
8(2B)	12	6	50	21	10
10(2B)	14.2	7	50	26	10
13(2B)	18	8	50	31	10

113.50 (inch)	D (mm)	ℓ (mm)	L (mm)	(g)	(pcs.)
3/8(2B)	14.2	7	50	26	10

HAND  
MANUALES  
Z-SERIES  
TITANIUM  
DE TITANIO  
ACCESSORIES  
ACCESORIOS  
SCREWDRIVERS  
DESTORNILLADORES  
IMPACT  
DE IMPACTO  
SLEEVE-DRIVE  
INDUSTRIAL  
INDUSTRIALES  
PROTECTOR  
PROTECTORES  
AUTOMOTIVE  
CONSTRUCTION  
CONSTRUCCION  
RENEWAL KITS  
JUEGOS DE HERRAS REPUESTO



**115-50**  Nut Setters with Magnet  
Vasos para tuercas con Imán

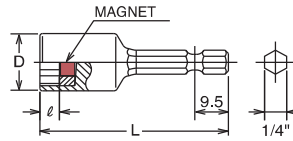

115.50 (mm)	D (mm)	l (mm)	L (mm)	(g)	(pcs.)
5.5	9	2.1	50	15	10
6	10	2.4	50	17	10
7	11	2.8	50	19	10
8	12	3.5	50	20	10
10	14.2	4.2	50	29	10
12	17	5.6	50	40	10
13	18	6	50	50	10
14	19	6.4	50	60	10

115.50 (inch)	D (mm)	l (mm)	L (mm)	(g)	(pcs.)
1/4	10	1.8	50	17	10
1/4(DP2.4)	10	2.4	50	17	10
5/16	12	3.5	50	20	10
3/8	14.2	4.2	50	29	10
1/2	18	6	50	50	10

**115-75 · -100 · -150 · -200 · -250**  Nut Setters with Magnet  
Vasos para tuercas con Imán

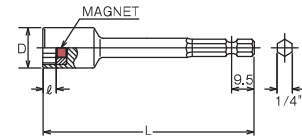

115.75 (mm)	D (mm)	l (mm)	L (mm)	(g)	(pcs.)
7	11.5	2.8	75	32	10
8	12.7	3.5	75	33	10
10	14.5	4.2	75	38	10
12	17	5.6	75	46	10
13	18	6	75	49	10
14	19	6.4	75	52	10

115.100 (mm)	D (mm)	l (mm)	L (mm)	(g)	(pcs.)
7	11.5	2.8	100	41	10
8	12.7	3.5	100	42	10
10	14.5	4.2	100	50	10
12	17	5.6	100	58	10
13	18	6	100	62	10
14	19	6.4	100	65	10

115.150 (mm)	D (mm)	l (mm)	L (mm)	(g)	(pcs.)
7	11.5	2.8	150	60	10
8	12.7	3.5	150	61	10
10	14.5	4.2	150	68	10
12	17	5.6	150	77	10
13	18	6	150	82	10
14	19	6.4	150	85	10

115.200 (mm)	D (mm)	l (mm)	L (mm)	(g)	(pcs.)
7	11.5	2.8	200	79	10
8	12.7	3.5	200	80	10
10	14.5	4.2	200	88	10
12	17	5.6	200	97	10
13	18	6	200	102	10
14	19	6.4	200	105	10

115.250 (mm)	D (mm)	l (mm)	L (mm)	(g)	(pcs.)
7	11.5	2.8	250	101	10
8	12.7	3.5	250	103	10
10	14.5	4.2	250	110	10
12	17	5.6	250	118	10
13	18	6	250	122	10
14	19	6.4	250	124	10



## 113UN-100 · -150 · -200

6-point Universal Joint Nut Setters  
Vasos para apretar tuercas Hexagonales con Articulación Universal

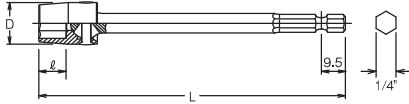

113UN.100 (mm)	D (mm)	l (mm)	L (mm)	(g)	(pcs.)
8	13	7	100	50	10
10	15	8	100	53	10
12	17	10	100	56	10
13	18	10	100	65	10
14	19.2	10	100	67	10

113UN.150 (mm)	D (mm)	l (mm)	L (mm)	(g)	(pcs.)
8	13	7	150	65	10
10	15	8	150	70	10
12	17	10	150	77	10
13	18	10	150	92	10
14	19.2	10	150	92	10

113UN.200 (mm)	D (mm)	l (mm)	L (mm)	(g)	(pcs.)
8	13	7	200	75	10
10	15	8	200	87	10
12	17	10	200	98	10
13	18	10	200	116	10
14	19.2	10	200	116	10

## 115G-75 · -100 · -150 · -200

Nut Setters with sliding Magnet  
Vasos para tuercas con Imán Corredizo

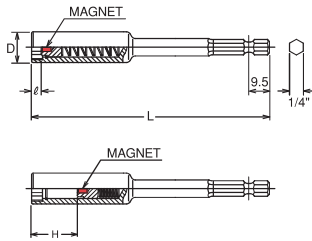

115G.75 (mm)	D (mm)	l (mm)	H (mm)	L (mm)	(g)	(pcs.)
7	11.5	3.5	26	75	34	10
8	12.7	4	26	75	41	10
10	14.5	4.5	26	75	48	10
12	17	6	26	75	65	10
13	18	6.5	25	75	70	10
14	19	7	24	75	73	10

115G.100 (mm)	D (mm)	l (mm)	H (mm)	L (mm)	(g)	(pcs.)
7	11.5	3.5	26	100	51	10
8	12.7	4	26	100	51	10
10	14.5	4.5	26	100	57	10
12	17	6	26	100	77	10
13	18	6.5	25	100	80	10
14	19	7	24	100	82	10

115G.150 (mm)	D (mm)	l (mm)	H (mm)	L (mm)	(g)	(pcs.)
7	11.5	3.5	26	150	67	10
8	12.7	4	26	150	70	10
10	14.5	4.5	26	150	77	10
12	17	6	26	150	95	10
13	18	6.5	25	150	100	10
14	19	7	24	150	105	10

115G.200 (mm)	D (mm)	l (mm)	H (mm)	L (mm)	(g)	(pcs.)
7	11.5	3.5	26	200	86	10
8	12.7	4	26	200	89	10
10	14.5	4.5	26	200	96	10
12	17	6	26	200	119	10
13	18	6.5	25	200	125	10
14	19	7	24	200	128	10

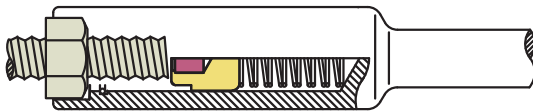

Sliding magnet system provides bolt clearance and magnetic function at the same time. The item 115G is mainly designed for assembly line work.

El sistema de imán corredizo proporciona espacio para el perno y al mismo tiempo acción magnética. El artículo 115G está diseñado específicamente para líneas de montaje.

119.50 (mm)	D (mm)	l (mm)	L (mm)	(g)	(pcs.)
5.5	9	2.1	50	17	10
6	10	2.4	50	20	10
7	11	2.8	50	22	10
8	12	3.5	50	23	10
10	14	4.2	50	30	10
12	17	5.6	50	42	10
13	18	6	50	52	10

## 119 Nut Setters with Magnet Vasos para tuercas con Imán

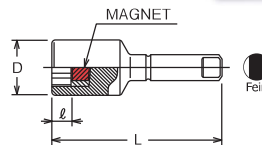

119.50 (inch)	D (mm)	l (mm)	L (mm)	(g)	(pcs.)
1/4	10	1.8	50	20	10
5/16	12	3.5	50	23	10
3/8	14	4.2	50	30	10

HAND MANUALES  
Z-SERIES  
TITANIUM DE TITANIO  
ACCESSORIES ACCESORIOS  
SCREWDRIVERS DESTORNILLADORES  
IMPACT DE IMPACTO  
SLEEVE-DRIVE INDUSTRIAL  
INDUSTRIALES  
PROTECTOR PROTECTORES  
AUTOMOTIVE  
CONSTRUCTION CONSTRUCCION  
RENEWAL KITS JUEGOS DE HERRAS REPUESTO

HAND  
MANUALES

Z-SERIES

TITANIUM  
DE TITANIO

ACCESSORIES  
ACCESORIOS

SCREWDRIVERS  
DESTORNILLADORES

IMPACT  
DE IMPACTO

SLEEVE-DRIVE

INDUSTRIAL  
INDUSTRIALES

PROTECTOR  
PROTECTORES

AUTOMOTIVE

RENEWAL KITS  
JUEGOS DE PIEZAS REPUESTO  
CONSTRUCCIÓN  
CONSTRUCCIÓN

**110-35B · -50B · -100B · -150B  
-35P · -50P · -100P · -150P**

Adaptors  
Adaptadores



110		TYPE	L (mm)	(g)	(pcs.)
1/4"	35B	Ball	35	9	10
	35P	Pin	35	9	10
	50B	Ball	50	15	10
	50P	Pin	50	15	10
	100B	Ball	100	34	10
	100P	Pin	100	34	10
	150B	Ball	150	54	10
	150P	Pin	150	54	10

● DIN 3126 Form E 6.3

**112-50B · -100B · -150B  
-50P · -100P · -150P**

Adaptors  
Adaptadores



112		TYPE	L (mm)	(g)	(pcs.)
3/8"	50B	Ball	50	21	10
	50P	Pin	50	21	10
	100B	Ball	100	71	10
	100P	Pin	100	71	10
	150B	Ball	150	121	10
	150P	Pin	150	121	10

● DIN 3126 Form E 6.3

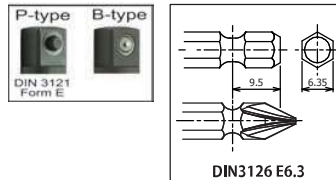

**135E-60B · -60P**

Adaptors  
Adaptadores



135E		TYPE	L (mm)	(g)	(pcs.)
1/2"	60B	Ball	60	46	10
	60P	Pin	60	46	10

● DIN 3126 Form E 6.3

**117-50B · -100B  
-50P · -100P**

Adaptors  
Adaptadores



117		TYPE	L (mm)	(g)	(pcs.)
1/4"	50B	Ball	50	15	10
	50P	Pin	50	15	10
	100B	Ball	100	71	10
	100P	Pin	100	71	10

● DIN 3126 Form G7

**120-50B · -50P**

Adaptors  
Adaptadores



120		TYPE	L (mm)	(g)	(pcs.)
3/8"	50B	Ball	50	27	10
	50P	Pin	50	27	10

● DIN 3126 Form E8

**186-75P**

Adaptors with Pin  
Adaptadores con Perno



186-75P		L (mm)	(g)	(pcs.)
3/8"	3/8"	75	65	10
1/2"	1/2"	75	85	10

● DIN 3126 Form E11.2

**BD022-120P**

Hammer Drill Adaptor  
Adaptador para Taladro de Percusión

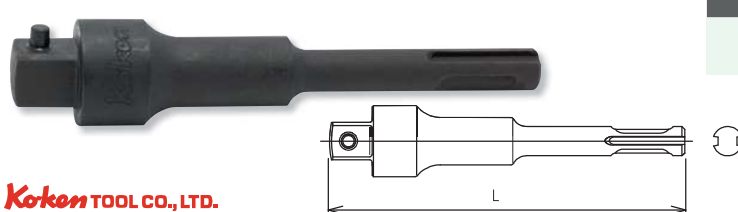

BD022-120P		L (mm)	(g)	(pcs.)
3/8"	3/8"	120	100	10
1/2"	1/2"	120	160	10