

Digital Torque Gauge HTGS/HTGA series

- Fast sampling for both Peak Values and Continuous Data, achieving high reproducibility
- Clear OLED display with a variety of significant capabilities
- Ideal for torque test of tightening/loosing screw and rotary switch
- Handles various samples by simply replacing optional attachments



HTGA-5N



Testing image of precision screw



Testing image of rotary switch

[Evolution to the Next Series]

Next Series is a generic term for IMADA Force-Gauges and Testing devices with upgraded functions, performances with the essential modifications.

New Series: HTGS/HTGA Series Firmware Ver.5 or later.

New Features

-Increased measurement stability achieved from further noise reduction to the measurement circuit.

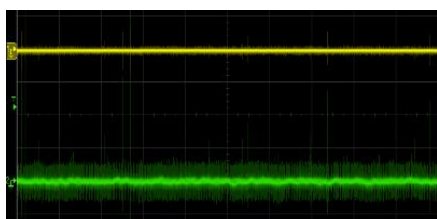

Analog output comparison
Yellow: Next series/Green: Old Model

-Force/Torque gauge program (firmware) online updates available.

-Various Software Downloads for additional options to increase the measurement conveniences.



<IMADA download site from end November 2021>

[Features]

Fast sampling for both Peak Values and Continuous Data, achieving high reproducibility

High-speed sampling of up to 2000 times/second updates measured values for more accurate peak-value readings.
Double bearing structure of the torque sensor minimizes the influence of bending force to ensure precise testing result.

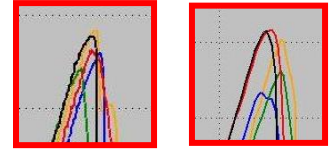

Destructive test comparison of the same sample by sampling speed: -
-Left Sampling speed 2000Hz
-Right Sampling speed 100Hz
The less variation shown in the left results

*The Test Results vary depending on the sample and measurement conditions.

Clear OLED display with a variety of significant capabilities

The OLED provides excellent contrast and high visibility, which reduces errors in reading measurement results.

In addition, the display screen can be divided into three sections, allowing to customize the display contents for liking, such as calendar, bar graph and Comparator setting values on the top and bottom.

In addition, it has various display capabilities such as a multi-language setting menu and overload warning display.

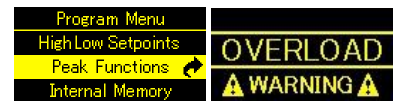

Measurement benefit increased by external output and practical functions

By providing a wide range of data output options such as USB, wireless, serial communication, and analog output, it can be used in a wide range of situations from data management on a PC to interlocking with various devices.

The system used to control external devices, such as stopping the machine at a specified load value, or to create an inspection device linked to a work process in order to improve the efficiency of the inspection process.

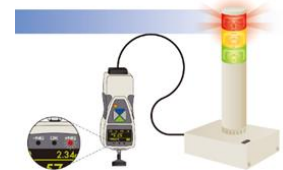

The warning light and other devices may be used to detect measurement abnormalities.

Allows easy Data acquisition and management with the included software

USB Cable and software *Force Logger* included in the original package to proceed with the data management when purchased.

It also allows to change and save the Force-Gauge settings from facilitating the management of measurement conditions. (Please refer to P.4 for the system requirements.)





Handles various samples by simply replacing optional attachments

It is easy to mount and replace your desired attachment such as pin chuck, tables and torque driver. Moreover, custom-made attachments suitable to your samples are also available.



* Optional attachments are sold separately.

[Original Features of HTGA series]

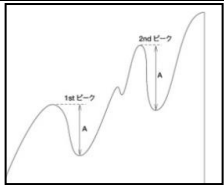
Angle output function	USB flash-drive for continuous data storage	Original display feature of HTGA
		
<p>-By connecting with an angle meter, the angle value is shown at the display top -It is also possible to output the Angle Data to a PC by using the dedicated software</p>	<p>-Continuous and Single data (with the button press) can be saved in USB flash-drive (*sold separately). -Data saved in CSV format. -Data acquirement is available even without PC</p>	<p>-1st and 2nd peak value displayed as the above graph -The statistics such as the Max/Min stored in HTGA can also be displayed</p>

[Specifications]

Model	HTGS	HTGA
Outline	Standard model with various functions	Advanced model with additional functions of HTGS series such as input/output angles and saving to USB flash drive,etc.
Accuracy	+/-0.5%F.S.+/-1digit	
Angle measurement range	-	0.1 to 9999.9 degrees (*4)
Unit of measurement (*1)	N-m, N-cm, kgf-m, kgf-cm, lbf-in, ozf-in (N-cm, kgf-cm, lbf-in and ozf-in are available for 0.5N-m.)	
Display	4-digit Organic EL	
Display update	16/sec	
Sampling rate	2000 data/sec at maximum (*2)	
Battery	Nickel-hydrogen battery/Operating time:6.5 hours (2 hours full charge) (*3)	
Safe overload rating	Approx.200%	
Operating environment	Temperature: 0 to +40 degree Celsius, Humidity: 20 to 80%RH	
Function	Customized display (header and footer), Peak hold (clockwise and counter-clockwise), Internal 1000 points data memory, Comparator (judgment of OK or NG), Reversible display, Sign inversion, Zero clear timer, +NG alarm, Off timer (auto power off), Dumping, Time display, setting lock	
	-	1st/2nd peak, Angle detection at torque peak value (*4), Angle zero reset at selected torque (*4)
Output	USB, RS232C, 2 VDC analog output (D/A), Comparator 3 steps (-NG/OK/+NG), Overload alarm	
	-	Sub comparator 2 steps (output of large or small judgment), USB flash drive, Angle(displacement) (*4)
Overload warning	Approx.110%F.S. (Warning message and alarm)	
External connecting switch	Power ON / OFF / Send and Hold / Zero reset / Peak and Real-time switching	
Weight	Display: approx.490g	
Dimensions	See [Dimensions]	
Accessory	AC adapter, Inspection certificate, CD driver (including data logging software), USB cable, Carrying case, L wrench, Handles (10N-m range only)	
	-	USB flash drive adapter (*5)

*1 These are the specifications for international model. Note that this unit is different from Japanese domestic model.

*2 The recording rate to USB flash drive is selectable among 1, 50 and 100/sec.

*3 The battery is more consumed when connected to USB flash drive or a displacement scale.

*4 Angle meter is necessary to activate these functions.

*5 USB flash drive is not included.

[HTGS/HTGA Series Models]

Model		Range	Display	Resolution
HTGA-0.5N (*1)	HTGS-0.5N (*1)	50N-cm	50.00N-cm	0.01N-cm
HTGA-2N	HTGS-2N	2 N-m (200N-cm)	2.000N-m (200.0N-cm)	0.001N-m (0.1N-cm)
HTGA-5N	HTGS-5N	5 N-m (500N-cm)	5.000N-m (500.0N-cm)	0.001N-m (0.1N-cm)
HTGA-10N	HTGS-10N	10N-m (1000N-cm)	10.00N-m (1000N-cm)	0.01N-m (1N-cm)

*1 The available unit is only "N-cm".

Cable Options			
	Code	Length	Description
Extension cable	-()m	5m/10m	It is an option to extend the load cell cable which connects to the amplifier (indicator).
Flexible cable	-BR()m	2m/5m/10m	It is an option to change the cable to high flexible cable to reduce the risk of breakage during bending.

* The cable type is changed from curly cord to straight one when the above option is selected.

* When ordering cable extension option, add the code to the end of model.
For example, when ordering HTGS-5N with 10m cable extension, the product model is "HTGS-5N-10m".

[Included Software]

-Force Logger: Data Acquisition Graphing Software

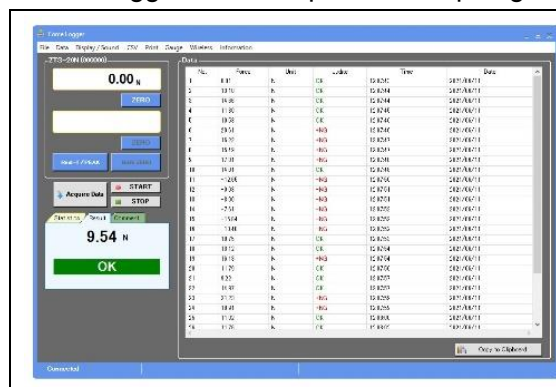

Main Functions

- Easy Importing of the Measurement Data
- Display Acquired Data Value Statistics: -Maximum / Minimum / Average Values.
- Data saved in CSV format
- Continuous Data acquisition up to 10 times per second.
- Force-Gauge Function Settings.







Operating environment

- OS: 7/8/8.1/10 (32/64bit version is available)
- Hardware: CPU Pentium4(1GHz or more), Memory 2GB, Hard disk: 10GB or more recommended
- Platform: .NET Framework4.6 or later

[Optional Cables]

Optional cables		
Analog Cable (3m)	CB-108	To connect to a multi meter, oscilloscope
RS232C Cable (3m)	CB-208	To connect to a PC having its own system
Contact point cable (3m)	CB-808	To connect to external equipment such as PLC
Open end cable (3m)	CB-908	Output cable for loose wire 37 pin (Useful for connection with unique equipment.)
Cable with Terminal Block	CTB-A	To connect to external equipment such as PLC



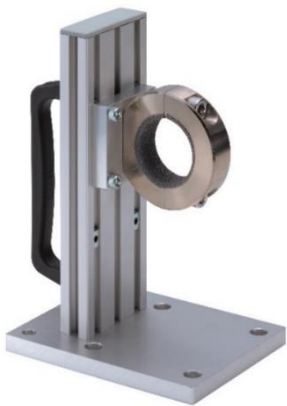

[Related Products (Optional Attachment)] *Optional attachment is required for measurements using the HTGS/HTGA series.

Small table HT-ST	Wide table HT-STW	Light weight small table HT-STL	Light weight wide table HT-STLW
For gripping small samples such as small bottle and key	Wide type of HT-ST for gripping samples from $\phi 10$ to 100mm	For small force measurement with light weight small table	Wide type of HT-STL for gripping samples from $\phi 10$ to 100mm
			
*Only for 2/5N-m range	*Only for 2/5N-m range	*Only for 0.5/2N-m range	*Only for 0.5/2N-m range
Socket holder HT-9.5SQ	Pin chuck HT-DC series	Torque driver HT-DBH/HT-DBH-P	M10 adapter HT-AD-M10
For various tools such as torque wrench or screw drive bit	For gripping columnar samples	For measuring tightening/loosening torque	For converting to M10 attachment
			

[Related Test Stand to Fix the Torque Gauge]

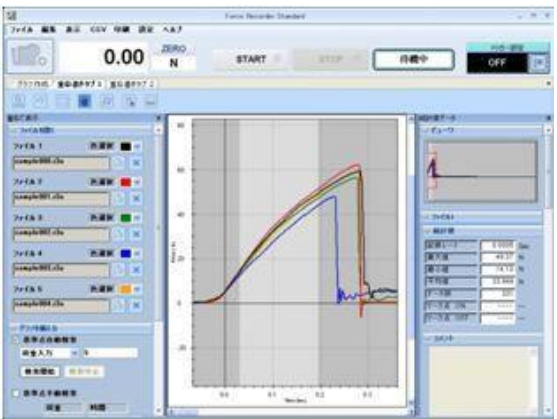
Rotation support jig for HTGS/A RSH series	
	<ul style="list-style-type: none"> - Manual rotation support jig for torque gauge HTGS/A series to measure torque in the horizontal direction - Ideal for analyzing torque-angle relationships by using an angle-meter - The sample of different sizes can be measured since the stage allows position adjustment for up to 105mm. - Suitable for testing a sample such as a screw that moves back and forth due to rotation. - The sample can be easily fixed and detached since the stage position is easily adjustable by lever.
Sensor Holder: SHT-5N	
	<ul style="list-style-type: none"> - Designed to hold the handheld type digital torque gauge horizontally or vertically - Enables high repeatability torque measurement by fixing the sensor - Attachable to your equipment by screws simply <p>[Horizontal Sensor Fixing] - Torque measurement of torsion spring, etc.</p> <p>[Vertical Sensor Fixing] - Turning torque of small screws or turbines. - Simple screw cap measurement, etc.</p> <p>* This sensor holder cannot be used with 10N-m range. * Refer to specification for SHT-5N for further information.</p>

[Related Products]

Graphing and Data Acquisition Software: Force Recorder Series	
 <p>The Standard Version Image</p>	<ul style="list-style-type: none"> -High-speed USB communication (up to 2000 times/second or 1000 times/second for Plus version) enables graphing for minimal load changes. -Up to 5 graphs overlaid for comparison with the Standard and Professional versions. (10 graphs with Plus version) -Notes added for record keeping of the measurements -For Data managing and reporting, Graphs pasted as the Image Data. <p>*4 Software versions available for different requirements、 (Force Recorder Light / Standard / Professional and Plus) Please refer to the individual Manuals for details.</p>
Wireless Data Transmit System: WL01 Series	
 <p>WL01-USB and WL01-ADP</p>	<ul style="list-style-type: none"> -Wireless communication allows the Data received from remote locations. -The Data reception detection and interference prevention functions support stable communication. -The communication format opened to the public and incorporated into the available facilities possible. <p>Note</p> <ul style="list-style-type: none"> -Compatible with firmware Ver3.10 or later. -Restrictions on the countries and regions for use. -Please refer to [Wireless System] Specifications for details.
Angle Unit: AMK series	Rechargeable Battery: BP-308
 <p>It is for HTGA series and your equipment for torque-angle testing.</p>	 <p>Rechargeable Battery for replacement</p>

[Related Torque Gauges]

Torque-Angle Measurement Unit TAA-HTG series	Screw Cap Torque Tester DTXS/DTXA series	eZ-Connect series: Sensor- interchangeable Amplifier eZT
 <p>It is complete system for Torque-Angle Measurements.</p>	 <p>It is ideal for measuring opening/closing torque of various samples such as bottles.</p>	 <p>The amplifier enables to connect to the various eZ-Connect Series Load Cells.</p>

[Dimensions]

Amplifier

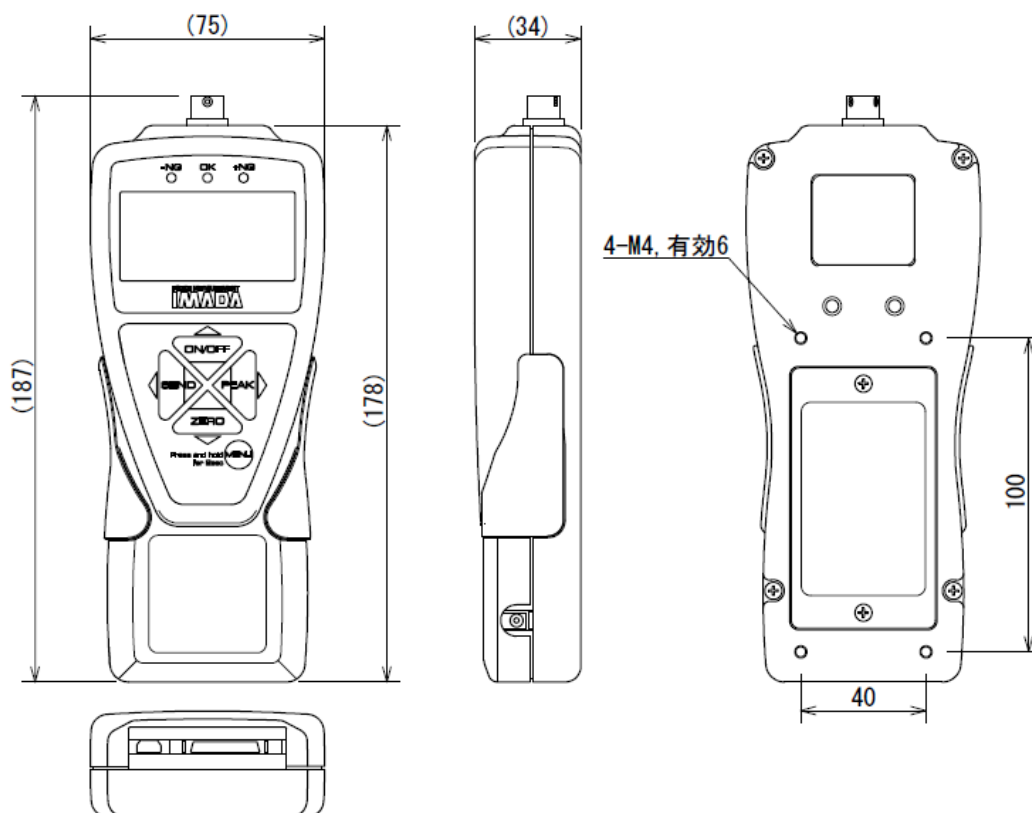

Torque Sensor: 0.5N-m/2N-m/5N-m

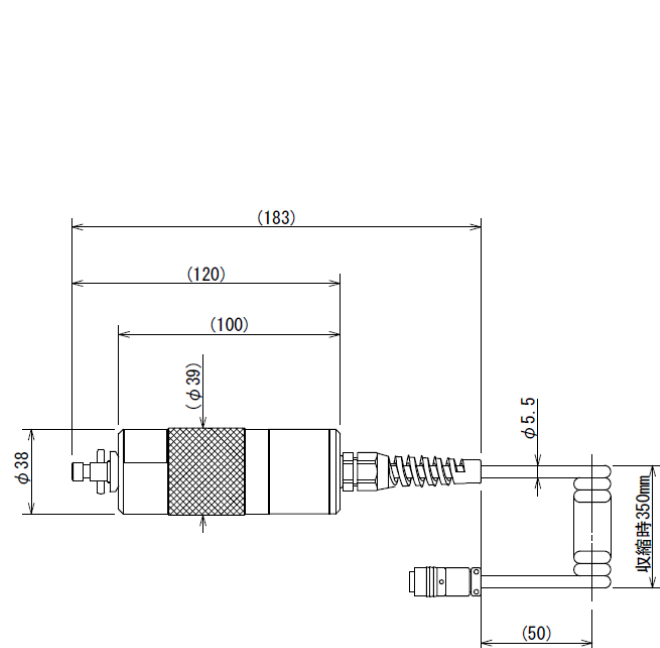

Torque Sensor: 10N-m

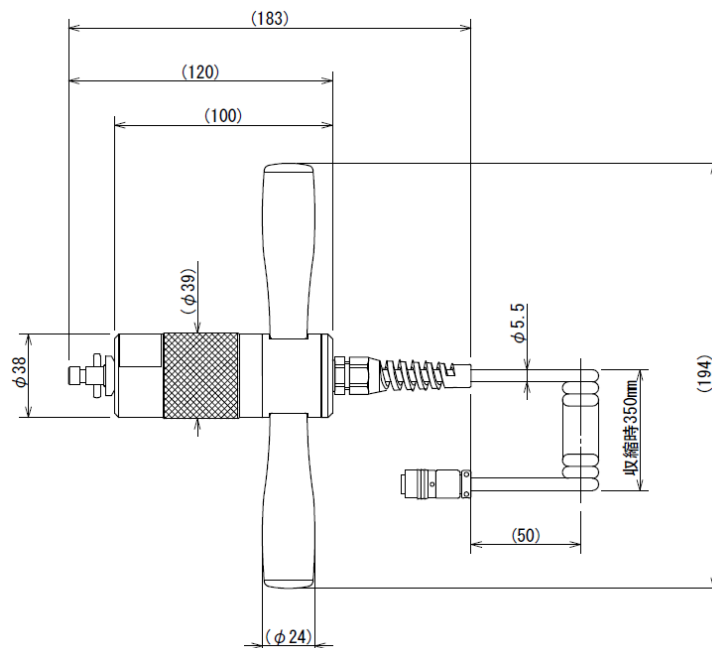

Unit: mm

[Calibration Certificate]

- We offer calibration certificate with extra charge.
- * Contact us or our distributor in your country for further information.

[Caution]

- Information in this document is subject to change without prior notice.
- This product is designed for force measurement purposes only.
- Do not copy and use this content without authorization.
- Do not apply force more than its capacity and from incorrect direction to the measuring shaft.
- Note that the allowable values may vary slightly depending on the unit selected on display. Please contact us for more information and details.

SHRADDHA IMPEX
Authorized Distributor

Email: shraddhaimpex@gmail.com / sales@shraddhaimpex.net
Web: www.shraddhaimpex.net
Contact: +91 9819530352 / +91 8591279918